

---

# PLANNING MALAYSIA

Journal of the Malaysian Institute of Planners

## *Advisor*

TPr. Hj Ihsan Zainal Mokhtar

## *Editor-in-Chief*

Professor Dato' Dr. Mansor Ibrahim  
*International Islamic University Malaysia (IIUM)*

## *Local Editorial Board Members*

- Professor Dato' Dr. Alias Abdullah - *International Islamic University Malaysia (IIUM)*  
Professor Dr. Ho Chin Siong - *Universiti Teknologi Malaysia (UTM)*  
Professor Dr. Jamilah Mohamad - *Universiti Malaya (UM)*  
Professor Dr. Ruslan Rainis - *Universiti Sains Malaysia (USM)*  
Professor Dr. Ahmad Nazri Muhamad Ludin - *Universiti Teknologi Malaysia (UTM)*  
Professor Dr. Dasimah Omar - *Universiti Teknologi Mara (UiTM)*  
Professor Dr. Suhana Shamsuddin - *Malaysia Institute of Planner (MIP)*  
Assoc. Prof. Dr. Jamalunlaili Abdullah - *Universiti Teknologi Mara (UiTM)*  
Assoc. Prof. Dr. M. Zainora Asmawi - *International Islamic University Malaysia (IIUM)*  
Assoc. Prof. Dr. Nurwati Badarulzaman - *Universiti Sains Malaysia (USM)*  
Assoc. Prof. Dr. Mariana Mohamed Osman - *International Islamic University Malaysia (IIUM)*  
Assoc. Prof. Dr. Syahriah Bachok - *International Islamic University Malaysia (IIUM)*  
Datin Paduka Dr. Halimatun Saadiah Hashim - *Malaysia Institute of Planner (MIP)*  
Assoc. Prof. Dr. Oliver Ling Hoon Leh - *Universiti Teknologi Mara (UiTM)*  
Dr. Chua Rhan See - *Jabatan Perancang Bandar dan Desa (JPBD)*  
Khairiah Talha - *Malaysia Institute of Planner (MIP)*  
Ishak Ariffin - *Malaysia Institute of Planner (MIP)*  
Assoc. Prof. Dr. Azizan Marzuki - *Universiti Sains Malaysia (USM)*

## *International Editorial Board*

- Professor Emeritus Dr. Richard E. Klosterman - *University of Akron / Whatif? Inc., USA*  
Professor Dr. Stephen Hamnett - *University of South Australia, Adelaide, Australia*  
Professor Dr. Kiyoshi Kobayashi - *University of Kyoto, Japan*  
Assoc. Prof. Dr. Belinda Yuen - *University of Singapore, Singapore*  
Dr. Davide Geneletti - *University of Trento, Italy*  
Dr. Boy Kombaitan - *Institut Teknologi Bandung, Indonesia*

***Editorial & Business Correspondence***  
PLANNING MALAYSIA  
Journal of the Malaysian Institute of Planners  
B-01-02, Jalan SS7/13B, Aman Seri, Kelana Jaya  
47301, Petaling Jaya, Selangor Darul Ehsan, MALAYSIA  
Tel: +603 78770637 Fax: +603 78779636 Email: mip@mip.org.my  
**www.planningmalaysia.org**



**Copyright © MIP, 2018**

All rights reserved.

No part of this publication may be reproduced, stored in a retrieval system, or transmitted in any form or by any means, electronic, mechanical, photocopying, or otherwise without the prior permission of the publisher.

The views expressed in this publication are those of the author(s) and do not necessarily represent the views of MIP.

This journal is a refereed journal.

All articles were reviewed by two or three unanimous referees identified by the Institute (MIP).

***Published By***  
**Malaysian Institute of Planners**

*ISSN Number*

1675-6215

*e-ISSN*

0128-0945



# CONTENTS

---

1.	Towards an Islamic Application of Visual Privacy Principles on Malaysian Terrace Housing: A Conceptual Framework <i>By: Azhani Abd Manaf, Zaiton Abdul Rahim, Noor Hanita Abdul Majid &amp; Spahic Omer</i>	1 - 11
2.	Perception of Quality of Life Among Community in Selangor <i>By: Nur Farhanah Rosli, Noor Suzilawati Rabe &amp; Mariana Mohamed Osman</i>	12 - 20
3.	Metals in Respirable and Inhalable Dust at Educational Institutions <i>By: ShamzaniAffendy Mohd Din, Nik Nurul-Hidayah Nik Yahya &amp; Rashidi Othman</i>	21 - 29
4.	Metal Exposure in Respirable & Inhalable Dust by the Locality of Coal-fired Power Plant <i>By: ShamzaniAffendyMohd Din, Nik Nurul-Hidayah Nik Yahya &amp; Rashidi Othman</i>	30 - 38
5.	Design Analysis to Achieve Green/Eco School Building Design Typology for Malaysia. <i>By: Zuraini Denan, Muhammad Afiq Helmi Mazlan, Noor Hanita Abdul Majid &amp; Nur Aliyah Zafirah Sanusi</i>	39 - 49
6.	A Parametric Approach for the Study of Heat Flow Between Street Canyon and the Atmosphere <i>By: Muhammad Abu Eusuf, Md Noor Salleh, Abdullah Al Mamun, Adnan M, MSR Sabaek Eusuf, Aatur Rahman &amp; Mansor Ibrahim</i>	50 - 61
7.	Heritage Building Preservation Through Building Information Modelling: Reviving Cultural Values Through High Level of Development Exploration <i>By: Maisarah Ali, Kamsiah Mohd Ismail, Khairusy Syakirin Has-Yun Hashim, Saifulnizam Suhaimi &amp; Muhammad Hadi Mustafa</i>	62 - 72
8.	The Basic Criteria for The Provision of Affordable Housing in Melaka <i>By: Mariana Mohamed Osman, Muhammad Adib Ramlee, Syakir Amir Ab Rahman &amp; Mansor Ibrahim</i>	73 - 82
9.	Design Elements of Houses Among Disabled Community: The Satisfaction and The Preferences <i>By: Syakir Amir Ab Rahman, Nasriah Samsudin, Mariana Mohamed Osman, Syahriah Bachok &amp; Noor Suzilawati Rabe</i>	83 - 88
10.	Determining Housing Affordability for Young Professionals in Klang Valley: Residual Income Approach <i>By: Nor Suzylah Sohaimi, Alias Abdullah &amp; Syafiee Shuid</i>	89 - 98
11.	Housing and Transport Expenditure: An Assessment of Location Housing Affordability <i>By: M. Azren Hassan, Hazlina Hamdan, Jamalunlaili Abdullah &amp; Yusfida Ayu Abdullah</i>	99 - 108

12.	Factors Determining the Demand for Affordable Housing <i>By: Xin Ying Lim, Abdullateef Olanrewaju, Seong Yeow Tan &amp; Jia En Lee</i>	109 - 118
13.	Factor Analysis on Hedonic Pricing Model on Open Space Affecting the Housing Price in Melaka and Seremban <i>By: M. Zainora Asmawi, Mohammad Abdul Mohit, Norzailawati Mohd. Noor, Alias Abdullah &amp; Tuminah Paiman</i>	119 - 130
14.	Mapping the Landscape Characters Along A Rural Route for Tourism <i>By: Nur Amirah Abdul Wahab, Khalilah Zakariya, Putri Haryati Ibrahim &amp; Illyani Ibrahim</i>	131 - 140
15.	Gen Z's Activities and Needs for Urban Recreational Parks <i>By: Nurfaezah Ghani, Mazlina Mansor &amp; Khalilah Zakariya</i>	141 - 152
16.	Historical Urban Form: A Case Study of Melaka <i>By: Illyani Ibrahim, Alias Abdullah, Mansor Ibrahim &amp; Fatin Farhana Murtaza</i>	153 - 163
17.	In Pursuit of Economically Competitive Agro-Tourism Sector: The Case of Terengganu Homestay, Malaysia <i>By: Syahriah Bachok, Tuan Anisdina &amp; Syakir Amir Ab Rahman</i>	164 - 174
18.	Homestay Operation Under the Purview of The Ministry of Tourism and Culture of Malaysia: The Case of Kelantan Homestay Operators <i>By: Syahriah Bachok, Hafizah Hasbullah &amp; Syakir Amir Ab Rahman</i>	175 - 185
19.	The Relevancy of Outdoor Classroom for PBL Approach in Selected University in Kuala Lumpur <i>By: Maheran Yaman, Fadzidah Abdullah, Nur Fadhilah Rozali &amp; Farha Salim</i>	186 - 196
20.	The Mediating Effects of Awareness on the Relationship Between Procurement Manual Compliance's Barriers and Cost Performace of Construction Projects <i>By: Abdullahi Nafiu Zadawa, Abdul Aziz Hussin &amp; Atasya Osmadi</i>	197 - 206
21.	Factors Influencing Parents in Selecting School for Children with Special Education Needs <i>By: Muhammad Faris, Ainul Ashiqin, Mariana Mohamed Osman &amp; Noor Suzilawati Rabe</i>	207 - 216
22.	A Study of Construction Waste Practice in Selangor <i>By: Khor Soo Cheen, Lim Chin-Yieh, Tan Seong Yeow, Olanrewaju Adullateef Ashola, Nik Nurul-Hidayah Nik Yahya, Wai Soon Han, &amp; Mohaad Nizam Yusof</i>	217 - 224
23.	Factors Affecting Housing Prices in Malaysia: Analysis on the Supply Side <i>By: Abdullateef Olanrewaju, Xin Ying Lim, Seong Yeow Tan, Jia En Lee, &amp; Hamimah Adnan</i>	225 - 235
24.	Maqasid al-Syariah & Human Well-being: A Study on Melaka's Public Housing <i>By: Syafiee Shuid &amp; Muhammad Faid Mohd Zamin</i>	236 - 245
25.	Identifying the Level of Community Involvement in the Community Activities at Kg. Kuala Telang, Kuala Lipis, Pahang	245 - 255

*By: Maheeran Yaman, Zainul Mukrim Baharuddin & Haza Hanurhaza Md Jani*

26. The Relationship Between Learning Space Attributes with Student' Satisfaction and Perceived Performance 256 – 265  
*By: Fadhlizil Fariz Abdul Munir, Asniza Hamimi Abdul Tharim, Thuraiya Mohd & Suzana Said*
27. Housing for Disabled People: What Do They Need? 266 – 274  
*By: Syakir Amir Ab Rahman, Nasriah Samsudin, Mariana Mohamed Osman, Syahriah Bachok & Noor Suzilawati Rabe*
28. Assessment on Seating Posture Relates to Risk Factors by Using Chi-square Test Among Elderly Taxi Drivers in Peninsular Malaysia 275 – 284  
*By: Ahmad Zuhairi Abdul Majid, Irwan Syah Md Yusoff & Shamsul Bahri Mohd Tamrin*
29. Physicochemical Properties and Pozzolanic Performance of Ultrafine Treated Rice Husk Ash (UFTRHA) as Additive in Concrete 285 – 292  
*By: Siti Asmahani Saad, Nasir Shafiq & Maisarah Ali*
30. Inhalable and Respirable Dust Concentration of Soiled Stone, Metal and Ceramic Artefact inside National Museum Malaysia 293 – 303  
*By: Shamzani Affendy Mohd Din, Nur Baiti Mat Husin & Rashidi Othman*
31. Classifications of Classical Malay Aristocratic Architecture Identifying Generic and Variant Forms 304 – 322  
*By: Tengku Anis Qariah Raja Abdul Kadir, Puteri Shireen Jahn Kassim, Noor Hanita Abdul Majid & Zumahiran Kamaruddin*
32. A Review of IBS Implementation in Malaysia and Singapore 323 – 333  
*By: Asiah Abdul Rahim & Sara Latif Qureshi*
33. A Comparative Review of Design Requirements for Natural Smoke Ventilation in Hospital Buildings 334 – 344  
*By: Mohd Zaid Bin Ab Ghani & Srazali Aripin*
34. Inclusive Disaster Risk Management (DRM) for Bertam Valley Community 345 – 352  
*By: Rashidi Sabri Muda, Izawati Tukiman, Mohd Ramzi Mohd Hussain & Ismawi Zen*

Notes to contributors and guidelines for manuscript submission

Ethics Statement

The past issues (articles)

## **MIP Council Members**

2017 - 2019 Session

---

### ***President***

TPr. Hj Ihsan Zainal Mokhtar (305/94)

### ***Immediate Past President***

TPr. Hj Md Nazri Mohd Noordin (301/94)

### ***Vice President***

Datin TPr. Hjh Noraida Saludin (468/02)

TPr. Mohamad Nazri Jaafar (168/86)

### ***Honorary Secretary***

Datin TPr. Hjh Mazrina Dato' Abdul Khalid (559/09)

### ***Honorary Treasury***

TPr. Mohd Zamri Husin (430/01)

### ***Council Members***

TPr. Lee Lih Shyan (267/92)

TPr. Hj Abdul Hamid Akub (450/01)

TPr. Hj Nik Mohd Ruiz Ahmad Fakhru Razzy (570/10)

Assoc. Prof. TPr. Dr. Saniah Ahmad Zaki (397/98)

TPr. Mohammad Fauzi Ahmad (418/99)

TPr. Mahani Mohd Yasin (614/12)

TPr. Nurul Sheema Abd Rahman (633/14)

TPr. Saiful Azman Abd Rashid (474/03)

TPr. Wan Andery Wan Mahmood (572/10)

TPr. Fathuddin Kamaruddin (656/16)

### ***Co-opted Members***

TPr. Victor Lai Wee Peng (502/05) - Chairman, MIP Sarawak & Sabah Chapter

TPr. Cheah Lye Aik (432/01) - Chairman, MIP Northern Branch

TPr. Abd Halim Ali Hassan (407/89) - Chairman, MIP Southern Branch

TPr. Philipose Philip (127/84)

Dato' TPr. Mohd Zaki Ibrahim (197/88)

Assoc Prof. TPr. Dr. Mariana Mohamed Osman (581/11)

TPr. Hj Mohd Asri Husin (259/91)

TPr. Ishak Ariffin (239/90)

Pn. Rozita Hamit

### ***Hon. Auditors***

TPr. Hj Lokman Omar (211/88)

Assoc. Prof. TPr. Hj Ahmad Suhaimi Ismail (245/91)

---



**TOWARDS AN ISLAMIC APPLICATION OF VISUAL PRIVACY  
PRINCIPLES ON MALAYSIAN TERRACE HOUSING: A  
CONCEPTUAL FRAMEWORK**

**Azhani Abd Manaf<sup>1</sup>, Zaiton Abdul Rahim<sup>2</sup>, Noor Hanita Abdul Majid<sup>3</sup>, &  
Spahic Omer<sup>4</sup>**

<sup>1,2,3</sup>*Kulliyyah of Architecture and Environmental Design*

<sup>4</sup>*Kulliyyah of Islamic Revealed Knowledge and Human Sciences*  
INTERNATIONAL ISLAMIC UNIVERSITY MALAYSIA

**Abstract**

This paper proposes a conceptual framework illustrating the application of Muslim Visual Privacy (MVP) of terrace housing by Malay occupants living in urban areas of Malaysia. Malay occupants are central to this study due to their specific views and requirements on visual privacy defined by religion and cultural norms. The study employs a thorough analysis of empirical data and review of past literatures in order to discuss vital and relevant theories. The findings of this study suggested a conceptual framework incorporating the sources of MVP elements as well as other important variables influencing the Malay Muslim occupants in terms of how they apply, regulate and modify the visual privacy levels in their respective terrace houses. The proposed framework might only represent a small portion in the entire effort, nevertheless it remains a significant contribution towards arriving at a more valid definition of MVP for Malay occupants in terrace housing. A clearer definition will then assist architects, developers as well as home owners' themselves in terms of how they design and manipulate physical elements of the house to achieve more functional visual privacy levels as per religious requirements.

**Keywords:** Malay, terrace house, Malaysia, Muslim Visual Privacy, Islamic, conceptual framework

## **INTRODUCTION**

There is a consensus in literature that each culture approaches privacy differently, although it is a common need across all cultures (Rapoport, 1969; Newell, 1995). This issue was further discussed by Altman (1977) on the differing methods and perception of various cultures regarding privacy regulations. Noorul Huda & Anwar (2013) in their study suggest that a proper application of religious beliefs, one of the main aspects being privacy, will enhance the overall quality of life and home. Islam placed the highest importance on visual privacy due to its direct impact on physical elements of the traditional Islamic city (Hakim, 2008).

Past studies defined visual privacy differently depending on the focus and issues of the studies. However, the studies ultimately relate back to the same point which is the visual permeability of a space or building (Hakim, 2008; Mortada, 2003; Reis & Lay, 2004; Shach-Pinsly, Fisher-Gewirtzman, & Burt, 2011). Most scholars tend to define them from the built environment's perspective. Thus they use terms 'visual corridors' (Hakim, 2008), 'visual integration' and 'control of visual connections' (Shach-Pinsly et al., 2011). The terms are mostly in reference to the visual line of sight created by the built environment and is independent of who is looking (person inside or outside), or the morale behind it.

## **THEORETICAL REVIEW**

### **A Visual Privacy - Definition and Factors**

The study by Reis and Lay (2004) defines visual privacy as what is visualized from a single point of view in a particular space (viewing angle and distance), and internal visual privacy regulation as controlling extent of visual integration; that is to block or allow visual connections. On the other hand, Shach-Pinsly et al. (2011) define visual privacy as an optimization process of controlling the level of visual exposure and visual openness. The definition is closer to Altman's (1977) definition of privacy regulation which described privacy as an open-close system to attain the optimum amount of privacy required specific to each individual's needs.

Furthermore, Bahammam (1998) outlines the roles of spaces, houses, street, and neighbourhood as contributing towards the overall visual privacy of the house environment. Visual privacy is the decisions which contribute towards visual separation between different sections and elements within the home, between the home and the street, and between dwelling units. The above suggestions, although clear in its own way, appears to be lacking certain morale or humanistic perspective which should be included, as behavioural mechanism is also a major component of visual privacy regulator other than the physical elements.

Altman and Chemers (1987), Zimring et al. (1978), Margulis (1974) and Al-Kodmany (1996) as cited by Abbasoglu and Dagli (n.d.) emphasize that any variable or sub-variable could be the focus of study in environment-behaviour



research, which in this study focuses on visual privacy. Review of literature presents the independent and dependent variables with regards to visual privacy as summarized in Table 1. Among the main focus of the studies were to analyze residential visual privacy and factors affecting it. Most studies take a general stance on privacy, thus there are still not many works of literature available exploring visual privacy specifically. Nonetheless, a general picture regarding the concept and factors affecting residential visual privacy has begun to take shape.

### **Visual Privacy from Islamic Perspective**

Privacy of the family in the house is of great importance in Islam as it is the sole right of the home owners to be able to rest his body and mind and to be happy within that space (Al-Kodmany, 1999; Hakim, 2008; Omer, 2010). Based on Sharia principles, Islamic scholars asserted that visual privacy is defined as the protection of the individual's *awrat* from the eyes of strangers (non-*mahram*) (Mortada, 2003), with a secondary goal of protecting the modesty of the family (Mortada, 2003; Omer, 2004) and lastly, fulfilling the rights of the neighbours to theirs (Hakim, 2008; Omer, 2004).

**Table 1: Empirical analysis of visual privacy**

<b>Author, year</b>	<b>Place of origin</b>	<b>Dependent variable</b>	<b>Independent variables</b>
Saleh (1998)	Saudi Arabia	Physical built environment	Visual privacy and communal socialization on physical built environment
Brown & Altman (1983)	USA	Residential burglary	- territorial markers - visual access
Reis & Lay (2004)	Brazil	Internal visual privacy	-visual and functional connections between the spaces -isovist area or visual field produced from the center of common area.
Sipahi (2016)	Turkey	External Visual privacy (visual privacy of windows only)	Right to a view (visual access) and right to be protected from visual overlooking (visual exposure).
Abdul Rahim (2015)	Malaysia	Visual privacy (definition, regulation and modification)	Religion and culture
Abbasog-lu & Dagli (n.d.)	Famagusta, Cyprus	Women's visual privacy	Architectural elements
Shach-Pinsly et al. (2011)	Non-Muslim / Israel	Visual privacy in general	Desired privacy and achieved privacy (optimization model)
Bermanian & Saremi (2015)	Iran	Visibility characteristics of physical built environment (external- windows only)	Visual exposure, and visual openness

Ayman (2011)	Jordan	Residential satisfaction of visual privacy	- Current perception, - satisfaction of building elements, - privacy regulation methods, - space usage pattern - house modification
Shabani et al. (2010)	Iran	Privacy (including visual privacy) level in modern housing	Flexibility patterns (between modern pattern to pattern based on privacy levels)
Kennedy, Buys & Miller (2015)	Brisbane	Overall residential satisfaction	Factors related to visual exposure (visual privacy) and visual access (access to sunlight and view)

The three levels of privacy which can be extracted from the definition are; 1) the privacy of the individual *awrat* from non-*mahram*, 2) the privacy of the daily life of the family and 3) the rights of the neighbours to their privacy. Muslim scholars tend to define visual privacy through a more humanistic angle (Mortada, 2003; Abdul Rahim, 2007; Hakim, 2008; Abdul Rahim, 2008). Hakim (2008) and Mortada (2003) for example, define visual privacy as protecting the family members especially the females from the unsolicited views of the non-*mahram*. The Islamic definition usually refers to the extent of the human body and the family relation. The human body refers to the extent of *awrat* as defined by Quran and Sunnah and non-*mahram* refers to strangers who are outside of the family nucleus (Mortada, 2003). Ayman (2011) on the other hand defines visual privacy as freedom to carry out daily routines free from observation of neighbours and passers-by.

These definitions of visual privacy were dependent on whom the visual intrusion is blamed on, the part of body which can be seen, one's position in the family (ie. in the nucleus or larger family circle?) and moral dimensions. The perspectives indicate that there is a need for a more comprehensive definition for visual privacy from Islamic perspective which takes into account the important factor of visual access as well.

An important study was done by Hakim (2008) whom framework outlined the static and dynamic variables pertinent to the shaping of Islamic urban built environment. The study referred to Shariah principles as static, while Islamic *urf* as dynamic factor. *Urf* are local cultural norms which are important factors in analyzing the application of visual privacy by a specific local Muslim community.

### **Culture and Visual Privacy of Housing from Islamic Perspective**

Islamic architecture is distinct from others due to the application of value system and custom (*urf*) relating to built environment. Islamic scholars refer to Surah 7:199 of the Quran in explaining the nature of *urf* which can be translated as

“Take things at the face value, and bid to what is customary (or accepted by local tradition), and turn away from the ignorant.” Hakim (1994) defines *urf*’ as custom or a habit, provides a unifying and diversifying factor to the housing of Muslim societies in the world (Hakim, 1994, 2008; Mortada, 2003; Omer, 2004). Islamic scholars agreed that the factor which unites any Islamic built environment is a set of guiding principles (value system) which come from the same source that is Qur’an and Sunnah (Hakim, 1994; Mortada, 2003).

As these values and customs spreaded across Muslim communities in the world, the nature of the *urf*’ may change to adapt to local culture and specific times and place (known as local *urf*’) (Hakim, 1994; Mortada, 2003). However, the basic values and guiding principles based on Sharia remained, thus uniting Islamic built design despite of its local cultures (Hakim, 1994, 2008; Mortada, 2003). On the other hand, latent literature further described that diversity between built environments in Muslim communities are due to the dynamic nature of the *urf*’ itself which is meant to be adapted to a particular time and place (Hakim, 1994; Mortada, 2003). The effect of the *urf*’ is more obvious in small scale changes made by decisions of individual residents. For example how a resident in Saudi Arabia modifies his house to make it more privacy compliant (Hakim, 1994), which mainly consists of small changes to the physical urban form made based on unified agreements after discussions and dialogues sessions (Omer, 2004).

In this study, Sharia principles related to built environment is the unifying element of Muslim housing. On the other hand, culture and other non-cultural factors are the diversifying elements (local *urf*’). This is supported by El-Shorbagy (2010) and Hakim (2008) whom both agree that each architectural element represents a solution to a problem which rises at a specific time. One of the main problems is to protect modesty (*awrat*) of the family in the house within the constraints of house construction of that time and place (Figure 1).

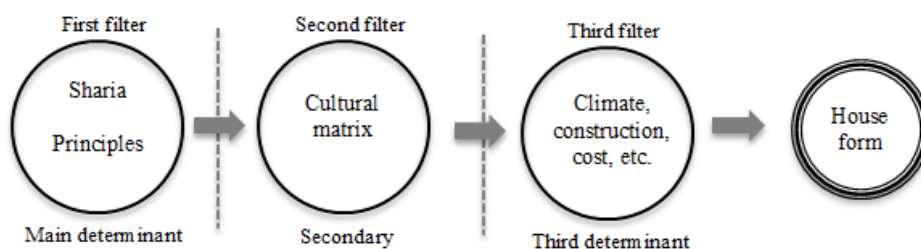


Figure 1: Factors influencing house form from Islamic perspectives

### Visual Privacy Regulations

The field of regulating visual privacy of the house environment can best be explained by Altman’s theory on privacy regulators. Altman (1977) theorizes that privacy regulators consist of three main mechanisms which are social,

behavioural and environmental. Social mechanisms are instilled and governed by the cultural institutions. Social mechanisms consist of social supports and policy supports which are both dependent on accepted practices, mores, roles, and rules. The second is behavioural mechanism that includes cognitive and overt behaviours. Factors which interest this study are the territoriality markers which are expressed as personal space, verbal and nonverbal behaviours. These two factors directly influence the characteristics of physical elements of the house, which falls under the third mechanism namely the environmental mechanism, which affects visual privacy levels. Furthermore, Altman (1977) and Ozaki (2002) strongly suggest that effective privacy regulations require a mixture of mechanisms working as a system achieving the required visual privacy level.

House modification was placed under the third mechanism which is the environmental mechanism. Environmental mechanism was defined by Kupritz, (2000, p.50) as “the physical elements, devised or deployed by designers, to regulate privacy.” Kupritz (2000) further explained that these physical elements function as apparatus used by individuals in controlling privacy levels. The physical elements are the lego blocks in constructing the required visual privacy levels and based on the frameworks, are directly affected by territoriality which is a behavioural mechanism. Therefore, physical elements of the house, other than being the elements proposed by designers in suggesting the “right” amount of visual privacy a house owner should have, are also territorial markers which a house owner can manipulate to achieve the “optimum” amount of visual privacy which they need.

### **Visual Restriction and Visual Access**

This study describes visual restriction and visual access as main variables affecting visual characteristics of a house. Shahch-Pinsley et al. (2001) describe visual restriction, which they termed as exposure, as being a component of visual privacy but not fully representing visual privacy. The same study defined visual restriction as: “the visual penetration of one’s privacy as a result of being viewed from the external spaces of other building facades or public spaces at street level” (Shahch-Pinsley et al., 2011, p.235). Meanwhile visual access, or openness, was defined as 3 aspects which are: 1) the measured length of built facades from which the view can be observed, 2) the measured area of built facades from which the view can be observed, and 3) the measured landscape area being viewed at street level and at every built storey (the isovist area) (Shahch-Pinsley et al., 2001). Additionally, visual restriction is related to negative intrusion, visual access on the other hand, has a positive connotation related to view.

This study highlights the importance of both visual restriction and visual access as factors of visual privacy. Review of traditional Islamic housing displayed the use of *masyrabiyya* or *roshin*, which reflects the need to allow visual access, mainly to allow female family members to view out, without being

viewed. Thus this study defines visual privacy of the house from Islamic perspective as the visual restriction of awrat and modesty of the family based on the requirements of Islamic principles while still allowing provision for visual access and its benefits.

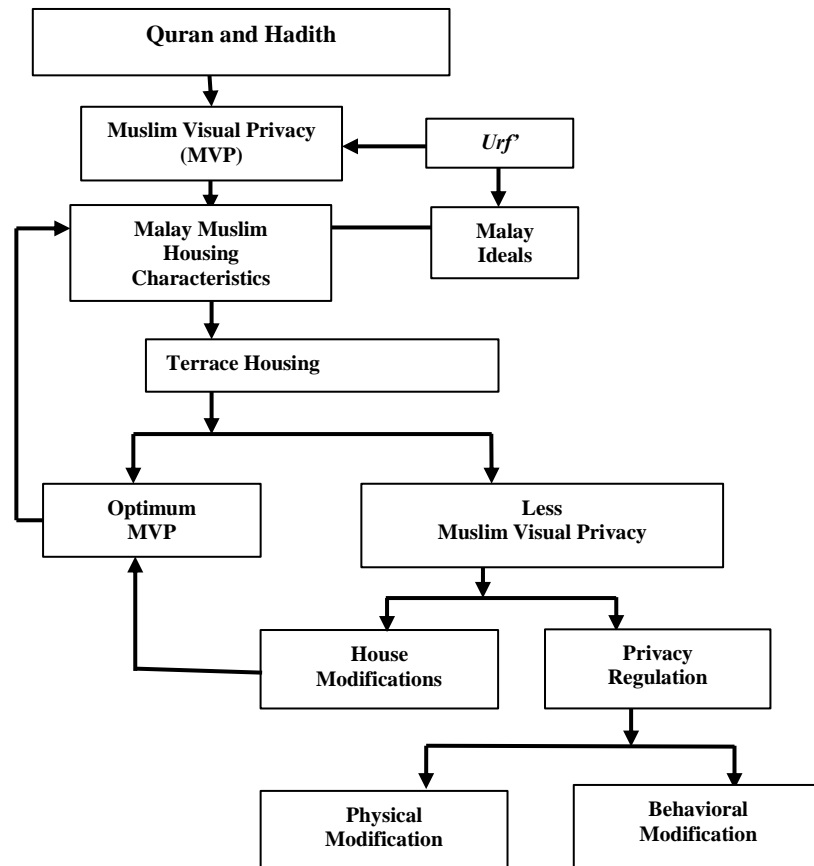
### **BACKGROUND**

According to Zulkeplee, Buys and Aird (2014) and El-Shorbagy (2010), Muslim houses came in a variety of forms and designs due to cultural diversity, yet unified by a few similar traits based on religious requirements. The traditional Malay house which is in line with said trend exudes sensitivity to socio-cultural and religious needs of the occupants. The terrace housing in Malaysia on the other hand, is a step backward, as it disregards the socio-cultural factors of its inhabitants.

Past studies by Abdul Rahim and Hashim (2008), Farah (2010) and Abdul Rahim (2008) highlight the lack of visual privacy encountered by Malay occupants of terrace housing in urban areas. Erdayu, Esmawee and Masran (2010 & 2012) point out that conflicts due to incompatibility of the home environment and cultural norms termed as 'housing stress' may have adverse psychological effects on the occupants. This ultimately leads to changes in behavioural norms and abandonment of required religious and cultural values (Abdul Rahim & Hashim, 2008; Farah, 2010). This study proposes the concept of MVP or Muslim visual privacy which adopts Islamic requirements for visual privacy in the housing setting as a basis and benchmark in housing design. This study focuses on terrace housing in urban areas.

### **FINDINGS - PROPOSED CONCEPTUAL FRAMEWORK**

Optimum level of MVP is an achievement of a balance between visual restriction and visual access. It displays a scenario of ideal balance of which the familial intimacy, *awrah* and security of the family are well protected and at the same time enables visual access to allow the efficient provision of security, sustainability and hospitality to the family. The MVP could be complemented by elements of visual modesty to achieve this optimum level.



**Figure 3:** Proposed conceptual framework  
 Source: Authors, 2017

Figure 3 above illustrates the dynamic system of visual privacy from Islamic perspectives. It suggests a continuous process of regulating visual privacy in order to fulfil Islamic requirements and achieve an optimum level of visual privacy. Furthermore, it indicated that a terrace house design should be composed of Malay Muslim Housing Characteristics made up of MVP elements which are influenced by local customs (*urf*) and Malay ideals (priorities and perception). The final step enters an optimization process, housing modification and privacy regulations. However the MVP should be found inadequate, the cycle would repeat itself.

## CONCLUSION

Based on the findings, this paper suggests a comprehensive conceptual framework incorporating the sources of MVP elements as well as other important variables influencing the Malay Muslim occupants in terms of how they apply, regulate and modify the visual privacy levels in their respective terrace house. In Islam, the concept of closure or protecting the privacy of the family is more of a requirement instead of preference with clear outline of the importance of sanctity of the family and awrat which needs to be restricted from the view of the non-mahram (stranger) eyes. An increase in visual access with its benefits and functions is detrimental to the level of visual restriction and privacy provided to the family, and vice versa. The issue regarding prioritization and awareness of the Malay occupants themselves is a critical matter which needs further analysis. As privacy is culturally specific, there is a need for adequate knowledge and awareness regarding the right definition, principles, and rules regarding visual privacy regulations from Islamic view with regard to a specific cultural context.

## REFERENCES

- Abbasoglu, M. S., & Dagli, U. U. (n.d.). *Women's visual privacy analysis in traditional houses and modern apartment block neighbourhoods in Famagusta (North Cyprus)*. Retrieved from <http://www.irbnet.de/daten/iconda/CIB16717.pdf>.
- Abdul Rahim, A. (2008). *Housing from Islamic perspective*. Kuala Lumpur: IIUM Press, International Islamic University Malaysia.
- Abdul Rahim, Z. (2007). Privacy and modification of terrace housing among Malay occupants in Klang Valley, Malaysia (Doctorate dissertation). Universiti Putra Malaysia, Serdang, Malaysia.
- Abdul Rahim, Z., & Hashim, A. H. (2008). The influence of privacy regulation on urban Malay families living in terrace housing. *International Journal of Architectural Research: ArchNet-IJAR*, 2(2), 94-102.
- Abdul Rahim, Z. (2015). The influence of culture and religion on visual privacy. *Procedia - Social and Behavioral Sciences*, 170, 537-544.
- Al-Kodmany, K. (1999). Residential visual privacy: Traditional and modern architecture and urban design. *Journal of Urban Design*, 4(3), 283-311.
- Altman, I. (1977). Privacy regulation: Culturally universal or culturally specific? *Journal of Social Issues*, 33, 66-84.
- Ayman N. T. (2011). Visual privacy recognition in residential areas through amendment of building regulations, urban design and planning. In *Proceedings of the Institution of Civil Engineers*, 1-11.
- Bahammam, A. (1998). Factors which influence the size of the contemporary dwelling: Riyadh, Saudi Arabia. *Habitat International*, 22(4), 557-570.

- Brown, B. B., & Altman, I. (1983). Territoriality, defensible space and residential burglary: An environmental analysis. *Journal of Environmental Psychology*, 3(3), 203-220.
- El-Shorbagy, A. (2010). Traditional Islamic-Arab house: Vocabulary and syntax. *International Journal of Civil & Environmental Engineering*, 10(04), 15-20.
- Erdayu, O. O., Esmawee, E., & Masran, S. (2010). Adapting by altering: Spatial modifications of terraced houses in the Klang Valley area. *Asian Journal of Environment-Behaviour Studies*, 2(2), 1-10.
- Erdayu, O. O., Esmawee, E. and Masran, S. (2012). Personalisation of the Home. *Procedia - Social and Behavioral Sciences*, 49, 328-340.
- Farah, M. Z. (2010). *The Malay women and terrace housing in Malaysia* (Master thesis). University of Wellington, New Zealand.
- Hakim, B. S. (1994). The urf and its role in diversifying the architecture of traditional Islamic cities. *Journal of Architectural and Planning Research*, 11(4), 108-127.
- Hakim, B. S. (2008). *Arabic-Islamic cities: Building and planning principles*. London: Routledge.
- Kupritz, V. W. (2000). Privacy management at work: A conceptual model. *Journal of Architectural and Planning Research*, 17(1), 47-63.
- Mortada, H. (2003). *Traditional Islamic principles of built environment* (1st Edition). New York: Routledge Curzon.
- Newell, P. B. (1995). Perspectives on privacy. *Journal of Environmental Psychology*, 15, 87-104.
- Noorul Huda, M. R., & Anuar, T. (2013). The concept of privacy and the Malay dwelling interior space planning. *Procedia-Social and Behavioral Sciences*. <http://doi.org/10.1016/j.sbspro.2013.07.214>
- Omer, S. (2004). *Studies in the Islamic built environment* (2nd Edition). Kuala Lumpur: Research Center, IIUM.
- Omer, S. (2010). *Islam & Housing* (1st Edition). Gombak, Malaysia: A.S. Nordeen.
- Ozaki, R. (2002). Housing as a reflection of culture: Privatised living and privacy in England and Japan. *Housing Studies*, 17(2), 209-227.
- Rapoport, A. (1969). *House form and culture*. New Jersey: Prentice-Hall, Inc.
- Reis, A. T., & Lay, M. C. (2004, July). Privacy in the dwelling: Attitudes, visual and functional connections. *18th IAPS-Conference Vienna, 2004*. July 7-10, 2004, Vienna, Austria.
- Saleh, M. A. E. (1998). The impact of Islamic and customary laws on urban form development in southwestern Saudi Arabia. *Habitat International*, 22(4), 537-556.
- Shach-Pinsly, D., Fisher-Gewirtzman, D., & Burt, M. (2011). Visual exposure and visual openness: An integrated approach and comparative evaluation. *Journal of Urban Design*, 16(2), 233-256.



- Sipahi, A. (2016). Window-conflicts in the Ottoman Empire and Turkey: Visual privacy, materiality and right to the city. *Middle Eastern Studies*, 52(4), 588-604.
- Zulkeplee O., Buys, L., & Aird, R. (2014). Observing privacy, modesty and hospitality in the home domain: Three case studies of Muslim homes in Brisbane, Australia. *International Journal of Architectural Research*, 8(3), 266-283.



## **PERCEPTION OF QUALITY OF LIFE AMONG COMMUNITY IN SELANGOR**

**Nur Farhanah Rosli<sup>1</sup>, Noor Suzilawati Rabe<sup>2</sup> & Mariana Mohamed Osman<sup>3</sup>**

*<sup>1,2,3</sup>Kulliyyah of Architecture and Environmental Design,*  
INTERNATIONAL ISLAMIC UNIVERSITY MALAYSIA

### **Abstract**

The quality of life (QOL) is a subjective matter that has been diversely defined by scholars. Since 1930s researchers from various fields have expressed interests in the definition of QOL, including investigating and measuring QOL using different methods. Over the last four decades, Malaysia has made remarkable achievements regarding its economic growth as well as its socio-economic development. Numerous factors have been identified that may affect the quality of life of people according to their personal preferences. For example, the quality of the individual work as an engineer may differ with the quality of life of an individual work as a teacher. Nevertheless, how the individual itself measures the quality of life can be different between each other. Definitions of quality of life are as numerous and inconsistent as the methods of assessing it. This paper highlights the perception towards the quality of life for the community living in the state of Selangor. The objectives of this research are to identify the current living condition in Selangor and the level of satisfaction towards the living condition in the State. Data was obtained through a questionnaire survey of 500 respondents living in Selangor. The outcome of the study indicates that the community in Selangor measured their quality of life differently based on their socio-economic background. Also, several indicators and action were highlighted by the community to be considered as part of the recommendation to improve the current living standard towards a better quality of life in Selangor.

**Keywords:** quality of life, quality, definition of quality

## **INTRODUCTION**

Year by year, development in Malaysia has increased rapidly to make the country move forward in parallel with other developing and developed countries. As the word ‘development’ is underscored, it is not only based by the presence of the various skyscrapers, but also includes the efficiency of public transportation, housing development and the decreasing of problem in the community such as poverty. These developments that happened in Malaysia may affected the level of quality of life (QOL) for the residents in this country whether the affect comes in the form of negative or positive. QOL is an oft-quoted phrased used in various context with heterogenous meaning (Nagchaudhuri, 1992). Quality of life is considered one of the most important dimension for sustaining any urban development (El Din, 2013). Different countries may gauge QOL by different concepts as they have different ways to undergo life and different problems to be tackled. Still, the basic elements of quality of life studied in each country are considered of similar essence or elements measuring quality of life.

## **LITERATURE REVIEW**

The literature captures the similar essence of the meaning of the quality of life which it often becomes the argument and rising questions especially based on the measurement and definition to achieve the good quality of life. Quality of life always captures the notion of the meaning by the term itself. Since early 90’s, the study of QOL has been explored. Diener and Suh (1997) is one of the early famous study of QOL that always being reffered to even presently. For example, can the quality of life be measured? If life’s quality can be measured, what are aspects that can be included as the key measurement to find the answer of a range of quality of life in the certain area. Other than that, the elements to achieve a good quality of life are also becoming a discussion among scholars. Thus, many key indicator systems are bringing into the measures and the interpretation of well-being and also satisfaction.

Nagchaudhuri (1992), and Bakar, Osman, Bachok, Zen and Abdullah (2017) said that the very first level of understanding, the concept of Quality of Life (QOL) is connected with psychological well being, which include the perception of health, adequate of nutritious food, shelter and adaptation to the environment including perception of the environment by each individual and group not only as resource but also as a resource of aesthetic satisfaction. However, in the year 2012, QOL refers to the day living enhanced by wholesome food and clean air and water, enjoyment of unfettered open spaces and water bodies, conservation of wildlife and natural resources, security from crime and others. The elements may be used to measure the energy and power a person owned that enable them to enjoy life (El Din, 2013).

In Malaysia context, QOL encompasses personal advancements, a healthy lifestyle, access and freedom to pursue knowledge, and attaining a

standard of living which surpasses the fulfillment of the basic and psychological needs of the individual, to achieve a level of social well-being compatible with the nation's aspirations. The meaning and identification of QOL by Economic Planning Unit mirror QOL definitions by certain scholars. QOL includes aspects of life that can affect our daily life and movement in life that concludes the life's quality of a certain individual.

### Quality of Life (QOL) Indicators

To measure QOL, various indicators are needed to take into account. For example, Albouy, Godefroy and Lollivier (2012) identify 9 indicators to measure the QOL in European countries. The indicators include the social and economic well-being such as material living conditions, financial risks to which people are exposed, their health, their level of education, working conditions, involvement in public life, contacts with others, economic security and physical security.

Meanwhile, the Malaysia Quality of Life Index (MQLI) 1999 has 38 indicators categorized under 11 components of QOL. However, Malaysia Well-Being Index (MWI) 2012 also use several indicators include in both social and economic well-being.

**Table 1:** Malaysia Well-being Index, 2013

Components	Index
<i>Economic well-being</i>	
Transport	136.9
Communications	136.2
Education	132.9
Income and Distribution	131.8
Working Life	128.6
<i>Social well-being</i>	
Housing	136.9
Leasure	131.4
Governance	128.1
Public safety	125.6
Social Participation	120.6
Culture	120.3
Health	114.1
Environment	107.3
Family	104.6

\*base year: 2000=100

The MWI measures the well-being of Malaysians from a multidimensional perspective. The index was formulated as a composite index using 14 components and 68 indicators. In this study, the performance of the MWI is complemented with a detailed analysis of the country's achievement in translating national income into well-being of Malaysians. Overall, the well-

being of the Malaysians has improved with most of the indices moving positively with the change in national income.

### **Policy and Thrust**

The national policy on environment has formulated to ensure the long term sustainability and improvement towards Quality of life. Bakar et al. (2017a, 2017b) mentioned that in order to improve quality of life, the basic amenities such as the access towards health facilities should be improved first.

In 11<sup>th</sup> Malaysia Plan, there are several times the word ‘quality of life’ being mentioned. One of the 11th Malaysia Plan objectives are to achieve good quality of life and sustainable well-being in by enhancing the economy of individual and create opportunity for these people in order to achieve good quality of life (Bakar et.al, 2017c). The Malaysia Plan also ensures more equitable access to the economic growth opportunity will increasing the wellbeing and quality of life by the communities. The six thrusts of the plan include the improving wellbeing for all Malaysian. The Government has always adopted a balanced development approach that gives equal emphasis to both economic growths and the community well-being. The well-being discusses about the standard of living and the quality of life of the community. The standard of living includes the individual’s socio-economic, physical and psychological needs (Bakar, Osman, Bachok, Zen, & Abdullah, 2017). The Government will improve the well-being of Malaysians including the socio-economic and geographic background of the community.

The next thrust that mention about the improving quality of life of Malaysian include the pursuing green growth for sustainability and resilience. The green growth refers to the growth that is resource efficient, clean and resilient. This strategy will lead to the better quality of growth, strengthened food, water and energy security, lower environment risks and ecological scarcities, and be better in well-being and quality of life.

### **METHODOLOGY**

In this research, the method used is a quantitative method. Quantitative method is used to emphasize objective measurements and the statistical, mathematical or numerical analysis that can be transformed into a usable statistic. The quantitative design is a research design attempt to maximize objective, replicability as well as the generality of findings. As this study focusses on assessment of the quality of life among communities in the urban area in Selangor, the key for the study is to the use of instruments such as survey to collect data. In addition, the survey method used include questionnaire that comprises numerous factors and elements of QOL mentioned by the community.

Likert scale of 0-10 is used in order to answer the questionnaire survey. The study will be focusing on selected quality of life’s indicators which are

economic capacity, transportation, living condition, environment, social involvement, public safety, health and physical well-being, daily activities, as well as educational background. Each of the elements consists of certain questions which will be mark by the respondents using Likert scale that has been provided The study focusing on 500 residents lives in the developed state in Malaysia namely Selangor. The convenient sampling method is used as it is the easiest to recruit subject for the study and to find the respondents for the study. The study attempts to analyse the results by using Relative Importance Index (RII) and correlation.

## FINDINGS AND DISCUSSION

500 respondents living in Selangor were selected. They were inquired on the nine main indicators selected for the study. Respondents selected are between the ages of 18- 75 years old. The respondents came from various demographic background and characteristics which makes the sampling randomly represent the population in Selangor.

**Table 2:** Respondents' profile

Respondents profile	Percentage (%)
<b>Age</b>	
20 & below	0.60
<b>21-30 years old</b>	<b>44.80</b>
31-40 years old	35.40
41-50 years old	11.40
51-60 years old	5.40
61-70 years old	1.60
71 and above	0.80
<b>Educational level</b>	
Primary School	2.2
Secondary School	23.6
STPM/Certificate/ Diploma	31.0
<b>Degree</b>	<b>37.4</b>
Master	4.6
PhD	1.2
<b>Number of household</b>	
1	10.4
2	11.2
<b>3</b>	<b>24.2</b>
4	22.2
5	17.4
6	9.6
7	2.6
8	2.2

9	0.2
<b><i>Range of household income</i></b>	
1,000 and Below	2.2
1,001-2,000	18.0
<b>2,001-3,000</b>	<b>22.8</b>
3,001-4,000	10.8
4,001-5,000	11.4
5,001-6,000	10.6
6,001-7,000	7.2
7,001-8,000	5.0
8,001-9,000	2.0
9,001-10,000	4.0
10,000 and above	6.0

Table 2 shows the respondents' educational background. Majority of the respondents comes from the age range of 21-30 years old (44.8 %). This age range can be considered as within the productive working age. Most of the respondents had bachelor degree (37.4%) as the highest education level followed by STPM/ Certificate and Diploma (31.0%). Most of the respondents reportedly had monthly household income between RM 2,001 and 3,000. Majority of the respondents had household size of three persons (24.2%).

In this study, the QOL indicators include the elements inside social and economic well-being. QOL in this study are based on the primary data collected from the field survey and measured using Relative Importance Index (RII). The method to calculate RII is:

$$RII = \frac{\sum W}{A * N}$$

W=weight given to each statement by respondents and range from 0-10

A= Higher respondents' integer

N= Total number of respondents

By using the equation above, the result of RII was ranked to identify the most important indicator answer by the 500 selected respondents around Selangor area. The higher values of index indicate higher QOL chosen by the respondents.

**Table 3:** RII index based on the QOL components

Components	RII	Rank
<i>1) Economic capacity</i>		
Satisfaction household income	0.616	2
Job satisfaction	0.662	1
Monthly income sufficiency	0.591	4

No problem of commuting cost	0.608	3
No problem to buy properties	0.39	5
<i>2) Transportation</i>		
Own transportation	0.841	1
Usage of public transportation	0.38	2
Public transportation preferable	0.359	3
<i>3) Living condition</i>		
Satisfaction of living place	0.739	1
Neighbouring with foreigners	0.551	3
Strategic house location	0.737	2
Adequate of PWDs facilities	0.411	4
<i>4) Environment</i>		
Air quality	0.722	2
Water quality and provision	0.749	1
Crowding and noise level	0.657	4
Protection and preservation of natural element	0.637	6
Overall landscape	0.644	5
Overall cleanliness	0.715	3
<i>5) Social involvement</i>		
Social interaction with residents of neighbourhood	0.627	3
Support from neighbours	0.630	2
Interracial relations	0.664	1
Involvement in club/association in neighbourhood/work place	0.527	5
Overall satisfaction with social interaction	0.59	4
<i>6) Public safety</i>		
Safety walking alone in day time	0.787	1
Safety walking alone in night time	0.653	6
24 hours of Police availability	0.674	4
24hours of fire bridges availability	0.654	5
Condition of street lighting	0.746	2
Overall satisfaction of safety conditions	0.723	3
<i>7) Health &amp; Physical well-being</i>		
Satisfaction of health condition	0.841	1
Energetic to woke up every morning	0.782	4
Monthly, weekly, daily check-up	0.485	7
Enough sleep	0.738	5
Perform daily activities	0.806	3
Never have unstable mood	0.721	6
Comfortability with physical appearance	0.811	2
<i>8) Daily activities</i>		
Plan daily activities	0.579	2
Record daily activities	0.399	5
Beneficial activities	0.635	1
Plan activities a week beforehand	0.476	3



Plan activities a month beforehand	0.446	4
<i>9) Education</i>		
Satisfaction with current educational background	0.710	2
Wish to continue study	0.608	4
Supportive if family members want to further study	0.919	1
Malaysia educational system generate ideas of students	0.685	3
<i>Overall satisfaction</i>		
In general, how much do you enjoying your life?	0.772	1
Overall, how would you rate your quality of life	0.744	2

Overall, the highest RII index noted by the result is 0.919 (education) which was supports from family members to continue study. Contrarily, the lowest RII index, 0.359, fell under the transportation indicators (public transport preferable by the respondents).

For QOL aspects of economic capacity, the highest RII index was job satisfaction (RII= 0.662) while the lowest RII index was no problem to buy properties (RII= 0.39). Even though the respondents were satisfied with their job, they still had problem in buying properties for either themselves or for their family. As for the transportation aspects, most of the respondents own private transports (RII= 0.841) which discouraged them from using the public transport.

Living condition aspect result that satisfaction of living condition result as the highest index (RII=0.739). As for the air quality, most of the respondents were satisfied with the air quality around their living place (RII= 0.722). Majority of the respondents feel safe to walk alone during day time. Additionally, majority of the respondents satisfied with their health condition (RII=0.841).

Majority of the respondents claim to have enjoyed their life (RII= 0.772) (RII=0.744). Generally, each of the elements inside the QOL indicators such as economic capacity, transportation, living condition, environment, social involvement, public safety, health and physical well-being, daily activities as well as education, affect one's life and the QOL of the individual.

It can be assumed that the QOL indicators are interrelated with each other. These include indicators such as the satisfaction towards household income, job positions, vehicle ownership and living place.

The perception of the 500 respondents in Selangor relate to the 11th Malaysia Plan thrusts. The objectives of the thrust is to achieve good QOL and to improve the QOL especially in the psychological, social well-being and physical needed.

## CONCLUSION

In a nutshell, the nine indicators of QOL were important aspects influencing one's life. Every aspect of the development gives impacts either positive or negatives towards the communities residing inside the developing areas as well as the

surrounding areas. The impact of development need to be studied before pursuing the development projects.

## REFERENCES

- Albouy, V., Godefroy, P., & Lollivier, S. (2012). *Measuring quality of life*. Retrieved from <https://www.insee.fr/en/statistiques>.
- Bakar, A. A., Osman, M. M., Bachok, S., Ibrahim, I., & Abdullah, A. (2017a). Sustainable well-being: An empirical exploration on human interdependence with other humans. *Advanced Science Letters*, 23(7), 6357-6361.
- Bakar, A. A., Osman, M. M., Bachok, S., Ibrahim, I., & Abdullah, A. (2017b). Sustainable well-being: An empirical exploration on human interdependence with the environment. *Advanced Science Letters*, 23(7), 6352-6356.
- Bakar, A. A., Osman, M. M., Bachok, S., Ibrahim, I., & Abdullah, A. (2017c). Assessment on subjective sustainable well-being for central region of Malaysia. *Advanced Science Letters*, 23(4), 2929-2933.
- Bakar, A. A., Osman, M. M., Bachok, S., Zen, I., & Abdullah, A. (2017). A theoretical assessment on sustainable wellbeing indicators for people interrelationships. *Planning Malaysia*, 15(1), 21-30.
- Bakar, A. A., Osman, M. M., Bachok, S., Zen, I., & Abdullah, M. F. (2017) A review on sustainable wellbeing indicators for human interrelationships with the environment. *Planning Malaysia*, 15(1), 357-368.
- El Din, H. S. (2013). Principles of urban quality of life for a neighborhood. *HBRC Journal*, 9(1), 86-92.
- Nagchaudhuri, B. D. (1992). *The quality of life*. India: Indian Institute of Advance Study



## **METALS IN RESPIRABLE AND INHALABLE DUST AT EDUCATIONAL INSTITUTIONS**

**Shamzani Affendy Mohd Din<sup>1</sup>, Nik Nurul-Hidayah Nik Yahya<sup>2</sup> &  
Rashidi Othman<sup>3</sup>**

<sup>1,3</sup>*Kulliyyah of Architecture and Environmental Design*  
INTERNATIONAL ISLAMIC UNIVERSITY MALAYSIA

<sup>2</sup>*Faculty of Engineering and Green Technology*  
UNIVERSITI TUNKU ABDUL RAHMAN, MALAYSIA

### **Abstract**

Haze episode has always becomes the one of the common reasons for emergency closing of school. Unique approach had been used to collect and examine the toxic metal of the respirable and inhalable dust by combining the latest personal cyclone and seven-hole head sampler together with the latest spectrometer of inductively coupled plasma-mass spectrometry (ICP-MS) in a single framework. Iron is found significantly different with the highest concentration at 107.895 ng m<sup>-3</sup>. The mean ranges of metal in respirable dust found in educational institutions are between 0.005 and 78.629 ng m<sup>-3</sup>. The findings of this research seen the amount of respirable dust exceeds more than 21.13 per cent than inhalable dust. Analysed metals found are not exceeding the ambient air exposure limit established by Department of Environment Malaysia. Hence, it is understood that the outdoor atmospheric environments of Malaysian educational institutions are non-hazardous for both visitors and occupiers (students and personnel). The high level of iron signify that it is safe for the crossing of children to have a traffic light in front of the school, but the idling of motor vehicles emitted more pollutant that risks health of the school children, teachers and officers. These suggest that when there are schools, there shall be constructed of flyover crossing for long term solution or with certain distance to traffic sources.

**Keywords:** inhalable dust, respirable dust, educational institution, human health, metal exposure.

<sup>1</sup>Assistant Professor at International Islamic University Malaysia. Email: shamzani@iium.edu.my

## **INTRODUCTION**

Assessments of heavy metals (Cr, Cu, Fe, Mn, Ni, Pb, V and Zn) were determined on particle concentrations at Gombak, Selangor. For the purpose of this study, a public college and a boarding school were selected. The two selected educational institutions are the Sekolah Integrasi Gombak (SIG) and Kolej Vokasional Gombak (KVG). The assessment of this type of built environment is significant as the precondition of education is a healthy educational institution microenvironment. However, several studies show that the classrooms and its surrounding area are hazardous.

This research aims at assessing the metal content of airborne particulates from outdoor of the educational institutions and its effect towards human health. Its objectives are to determine metal concentration contributed by the multi-sources surrounding the educational institutions and to compare the respirable and inhalable dust, metal concentration, and effects of airborne particulates towards human health.

## **AIRBORNE PARTICULATES IN EDUCATIONAL INSTITUTIONS**

The average age of children attending these educational institutions is from 13 to 18 years old, which could be classified under a risky group of people. Moreover, it is also found that in general views, Malaysian latest growth rate for the age between 0 and 14 years old and 15 and 64 years old are approximately at 7.799 and 20.501, respectively (Malaysia Statistical Department, 2015). Thus, indicating that the amounts of school children are increasing at a huge amount each year and most of the population are the school age children. As found by previous studies, the amount of time spend with the children in a school are approximately 30% and from 80 to 90% per day (Tofful & Perrino, 2015; Che, Frey, & Lau, 2015). The personal sampling against outdoor sampling also had been done through several studies (Branis, Rezacova, & Domasova, 2005; Che et al., 2015; Roosebroeck et al., 2007; Zhu, Hinds, Kim, & Sioutas, 2011; Janssen, Hoek, Brunekreef, & Harssema, 1999; Zhang et al., 2014). In comparison with other types of sampling, the results show high result in dust collected with personal sampler at the higher range of multiple concentrations.

The issue that widely arise in the assessment of children school environment are the traffic-related sources and its human health impact. Previous studies also show that the design of the roadways in support with the roadway element affect the movement of the vehicles that later causes the increase in concentration of the dust due to the vehicles activities and combustion of its energy (Zhu et al., 2011; Stridh, Andersson, Linder, Oscarsson, & Bang, 2002; Ibrahim & Ramli, 2009; Kulshrestha, Massey, Masih, & Taneja, 2014). The vehicle movement of acceleration, deceleration and stopping due to the cycle of traffic signal at the junctions affects the combustion of fuel and thus, affect the level of the heavy metal in dust concentration (Ibrahim & Ramli, 2009). During

peak hours, high capacities of vehicles are also believed to increase the iron (Fe) (Wahid et al., 2014), Ni and Cr (Kulshrestha et al., 2014) through the process of fuel combustion. These factors also largely contributed by the fuel type, vehicle type, utilization parameters and operating modes (Zhu et al., 2011).

The potential sources found in and surrounding the educational institutions based on previous research are crustal dust, indoor organic, movement of student, school personnel and paperwork, vehicle exhaust, traffic sources, industrial source, secondary inorganic components, the infiltration of outdoor air, inadequate construction characteristic of building, absence of automated air filtration system, building construction, inappropriate ventilation, use of cleaning products and procedures, resuspension of dust deposited indoors, soil-earth crust erosion, secondary reactions in atmosphere, high no. of person, high activity, ventilation system and location in the city (Branis et al., 2011; Tofful & Perrino, 2015; Zhang et al., 2014; Stridh et al., 2002). Moreover, the association between the teaching organisation that traffic-related sources and the level of health of its occupant had been explored by several researchers. This is for the respirable dusts and inhalable dusts (Janssen et al., 1999), are widely exposed towards the children. Human health also can be affected due to the metal found in particles and (Janssen et al., 1999).

## **MATERIALS AND METHOD**

Personal outdoor concentrations were collected for this study on the behaviour of the children, such as playing outdoors and hand-to-mouth contact contribute to exposure towards heavy metal pollution. This is also agreed by Branis (2005) that the empty classroom at night and during weekend found the PM<sub>10</sub> concentrations were double than the indoor. Thus, indicating that outdoor personal exposure of an educational institution is significant to be monitored and assessed. Therefore, this research applied personal sampler in order to measure an individual personal exposure to airborne particles. There are two types of sampling head being used that are the cyclone and 7 hole sampling head. Both represent the respirable and inhalable dust accordingly.

These factors of time-weighted concentration at various micro environment that people spend their time show the exposure of the individual towards the inhalable and respirable dusts. However, for the purpose of this study, in order to standardize the exposure time between this built environment, the normal global working hours at 8-hours personal exposure were collected. This is also based on the standard of sampling hours as recommended by Department of Safety and Health Malaysia (DOSH).

There were 12 samples collected. All 12 samples were collected from outdoor ambient of the teaching organisations. This research adopts the mass spectrometry analysis to trace metal element in the airborne particles that was collected on the 0.8µm pore size membrane cellulose filter paper. The nine

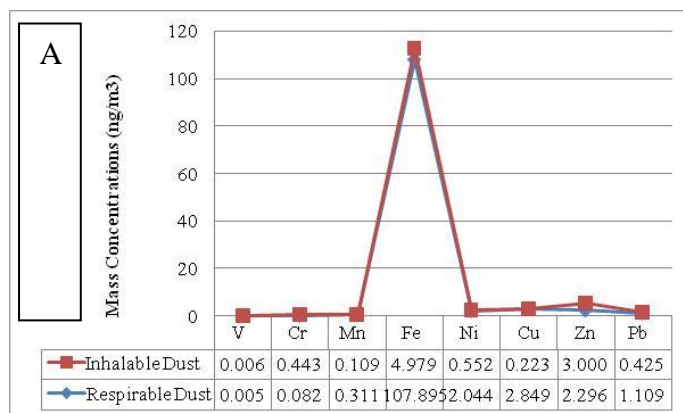
inorganic elements analysed in this research are Ba, Cr, Cu, Fe, Mn, Ni, Pb, V, and Zn. The metal concentrations are measured in SI unit of  $\text{mg}/\text{m}^3$ . The sampling was done at the outdoor ambient of SIG and KVG that located 720.39m in distance to each other.

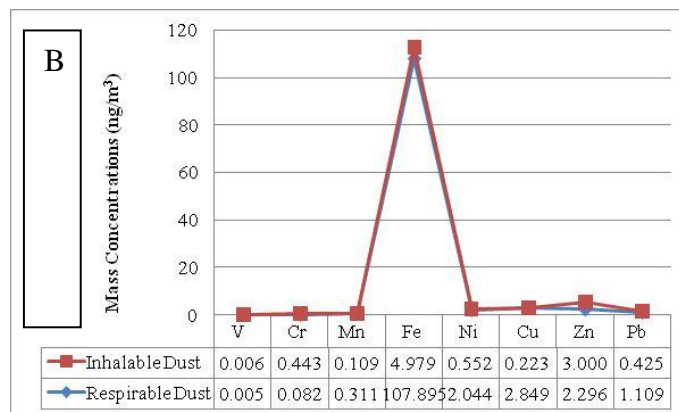
## RESULTS

The following graphs are illustrated based on the means and standard deviation found from the samples collected from the two educational institutions at Gombak, Selangor. The concentrations of V, Cr, Mn, Fe, Ni, Cu, Zn, and Pb value recorded dust at Sekolah Integrasi Gombak (SIG) and Kolej Vokasional Gombak (KVG) in Gombak, Selangor were illustrated in graphs as in the Figure 1.

Iron that was collected from the inhalable dust at the KVG had the highest concentrations in all samples from the teaching organization. In addition, this analysis also demonstrated that the KVG inhalable dust were found highest in Mn, Fe, Cu and Pb. The respirable result showed highest concentrations amount of V, Cr and Zn. The inhalable dusts at SIG were found highest in Ni and Ba. These data are highlighted in blue, below.

These analyses also discovered that no significant metals were higher and lower than each other between the respirable and inhalable dust. The mean ranges of respirable dust found in educational institutions were between 0.005 and  $78.629 \text{ ng m}^{-3}$ . The averages in inhalable dust were at 0.006 and  $37.749 \text{ ng m}^{-3}$ . Thus, sum up to an overall average for all metal concentrations at 0.005 and  $89.207 \text{ ng m}^{-3}$ , for respirable and inhalable dust, accordingly. The dominant metal for all sampling locations at educational institutions was Fe. The highest was iron for both inhalable dust and respirable dust at  $70.520$  and  $107.895 \text{ ng m}^{-3}$ , correspondingly. Thus, suggesting the amount of exceeded respirable dust towards the inhalable dust were at 21.13 per cent.





**Figure 1:** Heavy metal content in respirable and inhalable particulate matter at educational institutions in Gombak, Selangor.

Notes: A- SIG. B – KVG

### Observed Sources at the Educational Institutions

The area that surround the sampling sites are acknowledged as its locality. Through the locality observation, several sources from nature and manmade activities were found. These are listed in the following Table 1.

**Table 1:** The primary and secondary reactions found in SIG and KVG locality.

Primary Natural Sources	Both SIG and KVG exposed to the greenery conserved forest, limestone caves and hilly area, acid intrusive, lithosols types of soils and shallow latosols are found on steep hilly land.	
Secondary Mandmade Activities	SIG	This included the roadway pavement; railing; concrete kerbs; roof tiles, concrete and steel from the bus stop; roadway painting; steel and painting of the signage; concrete, roof tiles and paint from the nearby structure of post guard; concrete wall; paint; school concrete and steel gate; the steel and removable canopies from the stall and motor vehicles materials that are parked at temporal period.
	KVG	roadway pavement; railing; roadway painting; concrete kerbs; roof tiles; concrete wall; paint; steel, concrete, electrical components and plastic wears from the traffic light; steel, concrete, roof tiles, paint and plastic wear from the nearby structure of post guards and shop lots; the steel and removable

		canopies from stall and motor vehicles materials that are parked at temporal period nearby the KVG and educational schools.
--	--	---

This street is a busy way that lead to the nearby freeway. There are traffic lights in front of the schools and nearby the T-junctions. Thus, many vehicles have stopped in idling and waiting mode for a few minutes at the said traffic lights. Thus, indicates that this urban located educational institution contained a high concentration level of heavy metals as it was located nearby traffic lights (t-junctions and crossroads). In a perspective, it was safe for the crossing of children to have traffic light, but the idling mode by motor vehicles emitted more pollutant that risked health of the school children, teachers and officers. These suggested that when there are schools, there shall be construction of flyover crossing rather than the traffic light as the long term solution. It is to be highlighted that this layout of school was typical to the other schools in Malaysia.

The results suggested that the amount of idling motor vehicles is high in daily schools as the parents send and pick up their children at schools every morning, afternoon and evening. Thus, the children are exposed to traffic sources during most rush traffic hours in school. The human activities that occurred at both outdoor educational institutions were the movement of people to the nearby stall and shops. The cooking and smoking at the restaurants. People were transporting through these local streets nearby the teaching organisations from the universities surrounding houses area to the main road to city. In parallel with the above discussion, (Branis et al., 2005) stated that human activities are the changing agent of the undisturbed soils. In this case, the heterogeneous dust was formed and became road dust. For Malaysia, a hot and humid country, the earth crust is believed to dry (Ghosh, 2014). Hence resuspension of airborne particles occurs due to the human activities, mainly transportations in these sites.

### **Respirable & Inhalable Dust at Educational Institutions**

The above sources proved that the fine particles came from the combustion of motor vehicles, combustion of energy from cooking process and the dispersions through the wear breaks and tires of the motor vehicles; damage the road elements and building structures. However, it is believed that most of the respirable dust found was emitted by the motor vehicle emissions. This is in agreement with Ghosh (2014), Latif, Othman and Johnny (2006), and Laden, Neas, Dockery and Schwartz (2000). In line with the discussion by Branis et al. (2005), the features of coarse particles easily settled, letting them deposited at rapid gravity force outdoor. This also indicated the complexity of the coarse particle found outdoor of the educational institutions as rapid coagulation occurred in high airborne particle numbers causing the increased particles.



In addition, iron metal elements contributed by both coarse and fine particles in soil (Che et al., 2015; Salam, Hossain, Siddique, & Shafiqul Alam, 2008) were believed to occur both in respirable and inhalable dust fraction. Even though different types of particles were dominant by different chemical elements, the results shows a similar trend between both. Thus, suggested that both results were from similar sources. The above summaries of results showed that the metal contents found in respirable and inhalable dusts were varying. It was found that the mean concentrations ranged of respirable dust value were lower than the inhalable dust. The natural environment of lithosols type of soil and acid intrusive rocks, supporting this finding in Fe high concentration level that was found as a large contributor to the natural airborne particles. This is in agreement by previous researcher (Che et al., 2015; Wahid et al., 2014; Tahir, Suratman, Foo, Hamzah, & Latif, 2013).

#### **Iron Dominant the Respirable and Inhalable Dust**

Both of the teaching organisations were located in the urban background, hence the high concentration value was relevant to the urban area as found by Tahir Salam et al. (2008). Traffic emissions and soil entrainment that contributed to the formation of road dust at site were the potential sources of iron contamination in the dust samples. Therefore, the findings were supported by many scientists, that the Fe was found highest due to the industrial and traffic activities. Additionally, traffic emissions are further defined by Wahid et al. (2014), and Abbasi, Tufail and Chaudhry (2013), as the vehicular exhaust emission, non-engine combustion sources due to engine abrasion and clutch, break and tyres wear), and road infrastructure (corrosion of galvanized steel crash barriers, pavement wear). In this case, industrial source is to be omitted due to residential, commercials and educational institutions are the surrounding built environment of the area.

Furthermore, for ambient air in Malaysia, there are allowable exposure limit for lead, zinc and copper at  $0.025 \text{ mg m}^{-3}$ ,  $0.1 \text{ mg m}^{-3}$  and  $0.1 \text{ mg m}^{-3}$ , respectively. From the above results, the percentage of exceeding limit had been calculated. These data summarised that none of them exceeded the limits.

In the calculation of mean summaries of highest metal according site and types of dust it was clearly indicated that the highest metal concentrations levels were found in samples collected from KVG, whilst the Fe were the only metals found highest in the SIG samples. This highly supported the above discussions of locality that the crossroads provide higher metal accumulations in KVG samples. Therefore, in designing future roadways, the engineers should be alerted that crossroads should be avoided if there were any educational institutions constructed at the area.

## CONCLUSION

In conclusion, it is safer for the children crossing to have traffic light in front of the school. However the idling motor vehicles emitted pollutant that risked health of the school children, teachers and officers. Hence suggesting that there should be flyover crossing for long term solution or with certain distance to traffic sources.

## ACKNOWLEDGEMENT

The author would like to acknowledge the FRGS grant by Ministry of Higher Education and the International Islamic University Malaysia for facility supports to make this research possible.

## REFERENCES

- Abbasi, M. N., Tufail, M. A., & Chaudhry, M. M. (2013). Assessment of heavy elements in suspended dust along the Murree Highway near capital city of Pakistan. *World Applied Science Journal*, 21(9), 1266-1275.
- Branis, M., Rezacova, P., & Domasova, M. (2005). The effect of outdoor air and indoor human activity on mass concentrations of PM<sub>10</sub>, PM<sub>2.5</sub>, and PM<sub>1</sub> in a classroom. *Environmental Research*, 99(2), 143-149.
- Che, W. W., Frey, H. C., & Lau, A. K. H. (2015). Comparison of sources of variability in school age children exposure to ambient PM<sub>2.5</sub>. *Environmental Science & Technology*, 49(3), 1511-1520.
- Ghosh, M. K. (2014). An analysis of roadside dust fall in Bhilai-3 of Durg District Chhattisgarh, Central India and its impact on human health. *International Journal of Research in Environmental Science and Technology*, 4(2), 54-60.
- Janssen, N. A., Hoek, G., Brunekreef, B., & Harssema, H. (1999). Mass concentration and elemental composition of PM<sub>10</sub> in classrooms. *Occupational and Environmental Medicine*, 56(7), 482-487.
- Kulshrestha, A., Massey, D. Masih, J., & Taneja, A. (2014). Source characterization of trace elements in indoor environments at urban, rural and roadside sites in a semi-arid region of India. *Aerosol and Air Quality Research*, 14, 1738-1751.
- Laden, F., Neas, L. M., Dockery, D. W., & Schwartz, J. (2000). Association of Fine PM from different source with daily mortality in 6 US cities. *Environmental Health Perspectives*, 108(10), 941-947.
- Talib, Latif, M. T., Othman, M. R., & Johnny, Z. (2006). Kajian Kualiti Udara di Bandar Kajang, Selangor. *The Malaysian Journal of Analytical Sciences*, 10(2), 275-284.
- Malaysia Statistical Department (2015). *Population Statistics - Population ('000) by Age Group, 1891 – 2013*.
- Roosebroeck, V. S., Jacobs, J., Janssen, N. A. H., Oldenwening, M., Hoek, G., & Brunekreef, B. (2007). Long-term personal exposure to PM<sub>2.5</sub>, soot and NO<sub>x</sub> in

- children attending schools located near busy roads, a validation study. *Atmospheric Environment*, 41(16), 3381-3394.
- Salam, A., Hossain, T., Siddique, M. N. A., & Shafiqul Alam, A. M. (2008). Characteristics of atmospheric trace gases, particulate matter, and heavy metal pollution in Dhaka, Bangladesh. *Air Quality Atmospheric Health*, 1, 101-109.
- Stridh, G., Andersson, H., Linder, B., Oscarsson, J., & Bang, C. S. (2002). Total dust exposure and size distribution of airborne particles in day-care centres. In *Proceedings of Indoor Air 2002: Schools And Offices* (pp. 97-102).
- Tahir, N. M., Suratman, S., Foo, T. F., Hamzah, M. S., & Latif, M. T. (2013). Temporal distribution and chemical characterization of atmospheric particulate matter in the eastern coast of Peninsular Malaysia. *Aerosol and Air Quality Research*, 13(2), 584-595.
- Tofful, L., & Perrino, C. (2015). Chemical composition of indoor and outdoor PM<sub>2.5</sub> in three schools in the City of Rome. *Atmosphere*, 6(10), 1422-1443.
- Ibrahim, W. H. W., & Ramli, N. A. (2009). Human settlement development: A case study of mitigating air pollution emissions at traffic light junctions. In S. Sassen (Ed.), *Human settlement development* (Vol. 2) (pp. 35-55). Oxford: Eolss Co.
- Wahid, N. B. A., Latif, M. T., Suan, L. S., Domminick, D., Sahani, M., Jaafar, S. A., & Mohd Tahir, N. (2014). Source identification of PM in semi-urban area of Malaysia using multi-variate techniques. *Bulletin of Environmental Contamination and Toxicology*, 92(3), 317-322.
- Zhu, Y., Hinds, W. C., Kim, S., & Sioutas, C. (2011). Concentration and size distribution of ultrafine particles near a major highway. *Journal of the Air & Waste management Association*, 52(9), 1032-1042. <https://doi.org/10.1080/10473289.2002.10470842>
- Zhang, N., Han, B., He, F., Xu, J., Niu, C., Zhou, J.,...& Xu H. (2014). Characterization, health risk of heavy metals, and source apportionment of atmospheric PM<sub>2.5</sub> to children in summer and winter: an exposure panel study in Tianjin, China. *Air Quality Atmospheric Health*, 8(4), 347-357..



## **METAL EXPOSURE IN RESPIRABLE & INHALABLE DUST BY THE LOCALITY OF COAL-FIRED POWER PLANT**

**Shamzani Affendy Mohd Din<sup>1</sup>, Nik Nurul-Hidayah Nik Yahya<sup>2</sup> & Rashidi Othman<sup>3</sup>**

<sup>1,3</sup>*Kulliyyah of Architecture and Environmental Design*  
INTERNATIONAL ISLAMIC UNIVERSITY MALAYSIA

<sup>2</sup>*Faculty of Engineering and Green Technology*  
UNIVERSITI TUNKU ABDUL RAHMAN, MALAYSIA

### **Abstract**

The surrounding area of the coal-fired power plant are mostly exposed to its chemical contents. The world has witnessed multicasess relevant to mortality due to overexposure to coal materials. However, these factor have not been faced by the Malaysians. Still, it is significant to monitor and control the coal-fired power plant exposure. This research aims to identify the dominant metal within the radius of a coal-fired power plant combustion source point. The inhalable and respirable dust are being collected then analysed and calculated its Permissible Exposure Limit (PEL). Later, health impact knowledge is being synchronize with the obtained data. Hence, built environment at the radius 5km, 10km, 15km and 20km were being observed as well as inhalable and respirable dust. The data was analysed using the ICPMS (Nexion 300x) to trace the concentrations of metals. The metals include Ba, Cr, Cu, Fe, Mn, Ni, Pb, V, and Zn. Generally, the results showed that the total of respirable towards inhalable dust ratio of metal concentration found at Manjung was 88.62%. The highest concentration found in Iron was at 4.710 ng m<sup>-3</sup> for respirable dust and Zinc for inhalable dust at 7.387 ng m<sup>-3</sup>; thus, claiming both Iron and Zinc as the dominant metals in Manjung. The pattern of metals concentration found in this research proven that the FGD and ESPs application in Manjung coal-fired power plant contributed in reducing the airborne particles emissions. However, the PEL calculations showed exceeding limits of metals found on site. Hence affecting the human respiratory, cardiovascular and nervous systems. Therefore, new research in developing the policy for the construction of the coal-fired power plant, especially within the radius of residential and public area are in significant need.

**Keywords:** coal-fired power plant, residential, metal, inhalable dust, respirable dust

## **INTRODUCTION**

Airborne particles overexposure is believed to bring certain human disease (Wilson, 2015). Meetham, Bottom, Cayton, Henderson-Sellers and Chambers (1981) stress that the coal burning in the cities contributing to air pollution to human health was the direct effect of the airborne particles since 40 years ago. In a tragedy of London smog in the year 1952, there were about four thousand (4,000) premature deaths occurred.

In Manjung population scenario, the residents with nearest to 500m radius experienced many years of living in areas with high particle levels emitted from the coal-fired power plant. They were exposed to the risk of facing development of chronic bronchitis, premature death, decreased lung function and cardiovascular mortality (EPA, 2004; Lockwood, Welker-Hood, Rauch, Gottlieb, 2009). However, as for the visitors' condition, they were exposed to short-term coal particulate matter pollution either for hours or days. They would face risks of heartbeat irregularities, heart attacks, hospital admissions faulty respiratory symptoms, decreased lung function, increased emergency room visits for heart or lung diseases and premature deaths. These impacts on health would have a greater risk towards elderlies, children and people with heart or lung disease.

According to the US EPA (2004), the airborne particles cause adverse impacts on health towards human being. The sizes play a vital role, as the largest airborne particles provide lesser impact on health. While the coarse and fine particles lead to a health problem since they can be deposited into the lung and bloodstream. It is to be highlighted that the coal airborne particle is at the average size of less than 2.5  $\mu\text{m}$  called PM<sub>2.5</sub>. Therefore, it is also believed that it can be deposited into the lung system and causes respiratory illness (Wilson, 2015).

Moreover, Lockwood et al. (2009), emphasised that the coal airborne particles also affect all major organ systems of the body. Those are respiratory, cardiovascular and nervous systems. Contaminants from coal combustion processes can lead to a decrease in lung development of children, asthma, lung diseases and lung cancer. Furthermore, coal particulates could also affect the cardiovascular system by causing artery blockage that lead to heart attacks, cardiac arrhythmias, congestive heart failure and tissues death due to oxygen deprivation that root towards permanent heart damage. Furthermore, failure of nervous system could also transpire due to exposure from coal particulate matter. It is believed that coal contaminant could lead to stroke.

The aim of this research is to identify the dominant metal in both inhalable and respirable dust collected at the radius of a coal-fired power plant by measuring its Permissible Exposure Limit (PEL). Then, health impact knowledge was compared with the obtained data.

## **RESEARCH METHODOLOGY**

Analysis of metals at 10 different sampling sites, each with different site

background, by using the personal sampling pumps of airborne particles with cyclone and seven-hole heads was conducted. 20 contaminated samples were collected from 10 sampling points. The location of the sampling points are indicated in Figure 1.



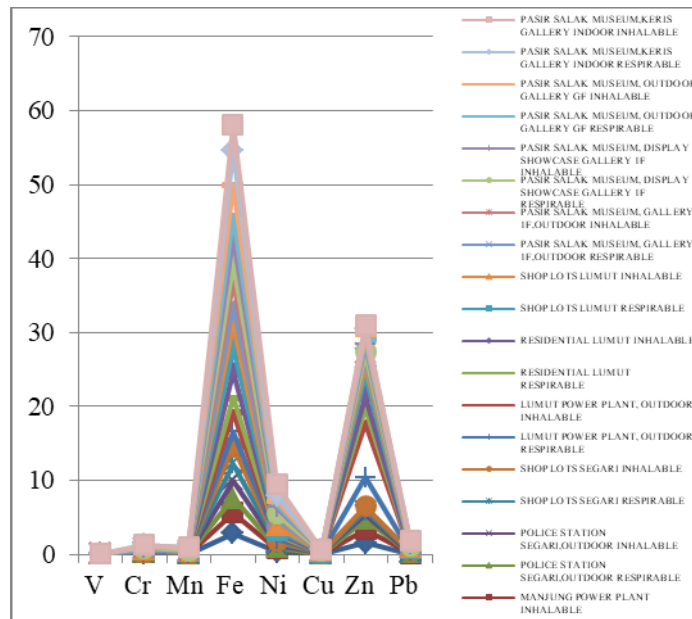
**Figure 1:** Map of Manjung with radius distance to Manjung Coal-fired Power Plant

It was done between two classifications of sizes of airborne particles which were respirable and inhalable dust. The metal contents test by using the ICPMS was done to determine the amount of concentrations of Ba, Cr, Cu, Fe, Mn, Ni, Pb, V and Zn, measured in SI unit of  $\text{mg}/\text{m}^3$ . The comparison of metal contents found from the power plants were analysed through this analysis by means of analysis of variance and bar chart illustrations.

## RESULTS AND DISCUSSION

The results in Figure 2 shows that the range of the readings in Manjung and Segari was about the same although the distance was 20 km away. However, contradictions was observed in the results at the car park area of Lumut Gas Cycle Power Plant. Another pattern of reading could be seen from the results at both building in Lumut which were the shop lots and residential area.

Moreover, the ratio of respirable dust to inhalable dust at shop lot units in Lumut read 124.45% which was higher than both sites in Segari that accumulated 109.58% and 91.45%, at Segari police station and shop lots, respectively. This amount was higher than the ratio found in Manjung. It could be viewed that the ratio of respirable dust to inhalable dust nearby Manjung Power Plant and Lumut residential area occupied lower ratio at 88.52% and 73.19%. It is observed that the pattern was not consistent with the area, but to the distance to the road traffic.



**Figure 2:** Concentrations of metal in respirable and inhalable dust sample collected at the locality of Manjung coal-fired power plant

Furthermore, at Pasir Salak Historical Complex, the ratio at the outdoor gallery in level one was higher than the ground floor at 25.36%. Additionally, the display showcase at gallery had lower respirable to inhalable dust ratio at 67.28%. From the entire samples collected in Pasir Salak Historical Complex, the indoor of ground floor result showed the highest concentration of respirable to inhalable dust ratio at 114.60%. Thus, it had a high risk towards the health of the personnel and visitors of this heritage sites.

The results further support the findings by Janssen, Hoek, Brunekreef, and Harssema (1999), and Oeder et al. (2012), where human presence offers multiple human activities which contributed to the ambient. The presence of indoor Pasir Salak Historical Complex respirable and inhalable dust was also contributed by the resuspension of soil dust from the outside that was brought in by the visitors and personnel's shoes on the carpets. Similarly, Janssen et al. (1999) found that the soil element had the highest I/O ratio while the combustion source had the lowest I/O ratio. The findings also clarified the reason of higher indoor air metal concentrations than in the outdoor air.

Furthermore, human activities at each locality affected the metal concentrations found in the collected respirable and inhalable dust. The activities of the residents in Manjung supported this result by showing high Iron and Zinc metal concentration. The result for Zinc element was similar with the result in the chapter above at 5 km away from the coal-fired power plant. Thus, strongly

suggesting that the combustion was from coal sources. The high respirable to inhalable dust ratio exceeded half of the full percentage was in line with the previous studies (Yi et al., 2008; Saarnio et al., 2014; Wilson, 2015) on the high amount of fine and ultrafine airborne particles found due to the coal combustion exposure. In agreement with a few researchers (Zhang et al., 2015; Kulshrestha, Massey, Masih, & Taneja, 2014; Cassee, Héroux, Gerlofs-Nijland, & Kelly, 2013) high Zn element in respirable dust was believed to cause stronger impacts on health to the Manjung population.

The results were supported by the previous researchers (Tahir, Suratman, Foo, Hamzah, & Latif, 2013; Wahid et al., 2014; Abbasi, Tufail, & Chaudhry, 2013; Kulshrestha et al., 2014; Che, Frey, & Lau, 2015; Zhang et al., 2015). Fe was still traced higher than Zn at most sampling areas in Manjung indicating that the humic gley soil entrainment and traffic emissions contributed to this result. Other sources include the traces of Fe and Zn elements at Manjung from the nearby metal steel factory (Zhang et al., 2015; Pekney et al., 2006) cement batching plant, and cooking combustion. Palomo, Alonso, Fernandez-Jiménez, Sobrado and Sanz (2004) stressed that fly ash is suitable to become the alkali-activated for cement due to the vitreous phase contents, particle size distributions and reactive silica content of fly ash. Therefore, the cement batching plant supported this finding. Non-combustion, lubricating and grease oil sources also caused the existence of Zn metal element on site. This was supported by few researches (Tahir et al., 2013; Wahid et al., 2014; Abbasi et al., 2013; Zhang et al., 2015). Moreover, it was found that both of the results in Segari and Manjung supported the idea of Kulshrestha et al. (2014) where the agriculture and construction sites observed, the results showed high Zn due to the heavy vehicular activities. Zn elements were found the highest in both respirable and inhalable dust due to the gas cycle turbine process. The secondary components which came from the reactions of the power plant equipment, which were the causes of the releases of inhalable dust, were found higher than the combustion sources.

Consistent results were obtained at every sampling location in Manjung. Only the Lumut Gas Cycle Power Plant had a contradicting result with Zinc element was found the highest in respirable dust. Therefore, it was strongly suggested that the combustion from coal sources were very reachable to this area. The pattern in Pasir Salak Historical Complex also showed high Ni metal element too, apart of Iron and Zinc. Comparing the results with the chemical elements of coal used for the coal-fired power plant in Manjung, it was strongly agreed that the Ni element could possibly come from the coal combustion. This high amount of Nickel element also proved the presence of human (visitors and personnel) at this area due to dust brought in by the skin, clothes, shoes, or the handling of materials (movement of handbags, brochures paper etc.). The soil dust deposited in carpets and acted as a sink. The walking and sitting causing the dust to crush against each other, thus compressing the carpets and creating a high velocity air



flow. This generates the airborne particles from the carpet. This is in agreement with the finding by Branis, Rezacova and Domasova (2005).

Findings at Pasir Salak Historical Complex were in contradiction with Branis et al. (2005), as the results showed that the inhalable dust metal concentrations were lower than the respirable dust found. Therefore, it was found that Pasir Salak Historical Complex indoor airborne particles were contributed most by the combustion sources from the outdoor areas that infiltrated through the glass door and the gaps between the wood floor panels. The usage of the HVAC was another triggering factor that caused high wind velocity to the indoor gallery ambient. Thus, this forced local turbulence to take place indoor by HVAC. This high velocity air flow let the combustion airborne particles from outdoor to be transported, resuspended and deposited indoor. This is supported by Baron and Willeke (2011) that the particle removals from surfaces are by air flow.

The coal combustion could cause adverse impacts on human health. This includes the residents or personnel who have inhaled the airborne particles for a long period of time or the visitors who inhaled the airborne particles for a short period of time. The standard for indoor concentration was referred to Permissible Exposure Limit, which was calculated based on the eight-hour TWA DOSH limitations, shows that none of the metal elemental concentrations exceed the limit. Similarly, the outdoor concentrations also did not exceed the limit specified by the Malaysia Environmental Quality Act regulation. However, following Table 1 are the diseases from iron as its presence was dominant in the metal concentrations in Manjung area.

**Table 1** Health diseases due to excessive exposure of Fe and Pb.

Iron related health diseases
<ul style="list-style-type: none"><li>● Large amounts of free iron in the circulation causes damage to critical cells in the liver, the heart and other metabolically active organs.</li><li>● Endocrinological</li><li>● Gastrointestinal</li><li>● Infectious</li><li>● Neoplastic</li><li>● Endocrinological</li><li>● Gastrointestinal</li><li>● Infections</li><li>● Orthopedic</li><li>● Pulmonary and vascular disease</li><li>● Alzheimers</li><li>● Parkinson</li><li>● Artherosclerosis</li><li>● Mortality</li><li>● Pathogenic invasions</li></ul>

*Source: US EPA (2015), Flora (2014), Ghosh (2014), Wilson (2015)*

## CONCLUSION AND RECOMMENDATIONS

The results in general showed that the total respirable dust to inhalable dust ratio of metal concentration found at Manjung was 88.62%. The highest concentration found in Iron was at 4.71 ng m<sup>-3</sup> for respirable dust and Zinc for inhalable dust at 7.387 ng m<sup>-3</sup>; thus, claiming both Iron and Zinc as the dominant metals in Manjung. The trace elements were also not aligned with traced metal in the coal test made in Kalimantan. Hence verifies that the FGD and ESPs application in Manjung coal-fired power plant had achieved its target in reducing the airborne particles emissions. However, it still can affect the human respiratory, cardiovascular and nervous systems.

The government should develop a new policy for the construction of coal-fired power plant, especially within the radius of residential and public area. It is also advisable for air pollutant experts and researchers in Malaysia to continuously monitor and collect samples from the locality of Manjung coal-fired power plant, especially during hot weather.

## ACKNOWLEDGEMENT

The author would like to acknowledge the FRGS 13-013-0254 grant by Ministry of Higher Education and International Islamic University Malaysia for facility supports to make this research possible.

## REFERENCES

- Abbasi, M. N., Tufail, M. A., & Chaudhry, M. M. (2013). Assessment of heavy elements in suspended dust along the Murree Highway near capital city of Pakistan. *World Applied Science Journal*, 21(9), 1266-1275.
- Baron, P. A. & Willeke, K. (Eds.) (2011). *Aerosol measurement: Principles, techniques and applications*. (2nd Edition). New York: Wiley-Inter-Science.
- Branis, M., Rezacova, P., & Domasova, M. (2005). The effect of outdoor air and indoor human activity on mass concentrations of PM<sub>10</sub>, PM<sub>2.5</sub>, and PM<sub>1</sub> in a classroom. *Environmental Research*, 99(2), 143-149.
- Cassee, F. R., Héroux, M.-E., Gerlofs-Nijland, M. E., & Kelly, F. J. (2013). Particulate matter beyond mass: recent health evidence on the role of fractions, chemical constituents and sources of emission. *Inhalation Toxicology*, 25(14), 802–812.
- Che, W. W., Frey, H. C., & Lau, A. K. H. (2015). Comparison of sources of variability in school age children exposure to ambient PM<sub>2.5</sub>. *Environmental Science & Technology*, 49(3), 1511-1520.
- Flora, S. J. (2014). Toxic metals: Health effects, and therapeutic measures. *Journal of Biomedical and Therapeutic Sciences*, 1(1), 48-64.
- Ghosh, M. K. (2014). An analysis of roadside dust fall in Bhilai-3 of Durg District Chhattisgarh, Central India and its impact on human health. *International Journal of Research in Environmental Science and Technology*, 4(2), 54-60.
- Janssen, N. A., Hoek, G., Brunekreef, B., & Harssema, H. (1999). Mass concentration and elemental composition of PM<sub>10</sub> in classrooms. *Occupational and Environmental Medicine*, 56(7), 482-487.
- Kulshrestha, A., Massey, D. Masih, J., & Taneja, A. (2014). Source characterization of trace elements in indoor environments at urban, rural and roadside sites in a semi-arid region of India. *Aerosol and Air Quality Research*, 14, 1738-1751
- Lockwood, A. H., Welker-Hood, K., Rauch, M., & Gottlieb, B. (2009, November 12). Coal's assault on human health. Retrieved from <https://www.psr.org/blog/resource/coins-assault-on-human-health/>.
- Meetham, A. R., Bottom, D. W., Cayton, S., Henderson-Sellers, A., & Chambers, D. (1981). *Atmospheric pollution, its history, origins and prevention* (4<sup>th</sup> edition). Oxford; New York: Pergamon Press.
- Oeder, S., Dietrich, S., Weichenmeier, I., Schober, W., Pusch, G., Jörres, R. A.,...& Buters, J. T. (2012). Toxicity and elemental composition of particulate matter from outdoor and indoor air of elementary schools in Munich, Germany. *Indoor Air*, 22(2), 148-58.
- Palomo, A., Alonso, S., Fernandez-Jiménez, A., Sobrados, I., & Sanz, J. (2004). Alkaline activation of fly ashes: NMR study of the reaction products. *Journal of the American Ceramic Society*, 87(6):1141-1145.

- Pekney, N. J., Davidson, C. I., Robinson, A., Zhou, L., Hopke, P., Eatough, D., & Rogge, W. F. (2006). Major source categories for PM<sub>2.5</sub> in Pittsburgh using PMF and UNMIX. *Aerosol Science and Technology*, 40(10), 910-924.
- Saarnio, K., Frey, A., Niemi, J. V., Timonen, H., Rönkkö, T., Karjalainen, P.,...& Keskinen, J. (2014). Chemical composition and size of particles in emissions of a coal-fired power plant with flue gas desulfurization. *Journal of Aerosol Science*, 73, 14-26.
- Tahir, N. M., Suratman, S., Foo, T. F., Hamzah, M. S., & Latif, M. T. (2013). Temporal distribution and chemical characterization of atmospheric particulate matter in the eastern coast of Peninsular Malaysia. *Aerosol and Air Quality Research*, 13(2), 584-595.
- US EPA (2004). *The particle pollution report: current understanding of air quality and emissions through 2003*. Research Triangle Park, NC: US Environmental Protection Agency.
- US EPA (2015). Lead Compounds. Technology Transfer Network Air Toxics Websites. Retrieved June, 26, 2015 from <http://www.epa.gov/ttn/atw/hlthef/lead.html>
- Wahid, N. B. A., Latif, M. T., Suan, L. S., Domminick, D., Sahani, M., Jaafar, S. A., & Mohd Tahir, N. (2014). Source identification of PM in semi-urban area of Malaysia using multi-variate techniques. *Bulletin of Environmental Contamination and Toxicology*, 92(3), 317-322.
- Wilson, L. (2015, May). *Lead*. Retrieved from [drwilson.com/articles/LEAD.htm](http://drwilson.com/articles/LEAD.htm)
- Yi, H., Hao, J., Duan, L., Tang, X., Ning, P., & Li, X. (2008). Fine particle and trace element emissions from an anthracite coal-fired power plant equipped with a bag-house in China. *Fuel*, 87(10), 2050-2057.
- Zhang, N., Han, B., He, F., Xu, J., Niu, C., Zhou, J.,...& Xu H. (2014). Characterization, health risk of heavy metals, and source apportionment of atmospheric PM<sub>2.5</sub> to children in summer and winter: an exposure panel study in Tianjin, China. *Air Quality Atmospheric Health*, 8(4), 347-357.



**PLANNING MALAYSIA:**  
*Journal of the Malaysian Institute of Planners*  
**VOLUME 16 ISSUE 2** (2018), Page 39 - 49

## **DESIGN ANALYSIS TO ACHIEVE GREEN/ECO SCHOOL BUILDING DESIGN TYPOLOGY FOR MALAYSIA**

**Zuraini Denan<sup>1</sup>, Muhammad Afiq Helmi Mazlan<sup>2</sup>, Noor Hanita Abdul  
Majid<sup>3</sup>, & Nur Aliyah Zafirah Sanusi<sup>4</sup>**

*<sup>1,2,3,4</sup>Kulliyyah of Architecture and Environmental Design*  
INTERNATIONAL ISLAMIC UNIVERSITY MALAYSIA

### **Abstract**

Ever since the first establishment of the public school (primary and secondary school) in Malaysia, the building design for most of the schools is almost the same until now. Public school for primary and secondary education is based on a standard layout designed by the Malaysian Public Works Department. Evolution of varieties education system employed by the schools does not affect the physical design of school. The emergence of awareness on sustainability and promotion towards green way of life has made it crucial for designer to rethink the best design for school in enhancing its environment that could be the “third teacher” to the pupils. The research attempt to explore design criteria of green school in Malaysia based on the critical elements of green initiatives. Recommendation of green/eco school design will be presented based on site and building planning, climate and green technology application

**Keywords:** school, green, design, environment, education

<sup>1</sup>Assistant Professor at International Islamic University Malaysia. Email: dzuraini@iiu.edu.my

## **INTRODUCTION**

The education system in Malaysia has changed occasionally, yet the physical form of the school remains almost the same. More schools (primary and secondary) were built to fulfill the needs of the children education in Malaysia. A total of 10,117 number of school buildings; excluding the number of pre-school, was recorded in Malaysia (Roslizar, Alghoul, Bakhtyar, Asim, & Sopian, 2014). The same prototype school building design was repeated all over Malaysia.

The space planning of standard school building design are based on the syllabus of the latest curriculum for primary and secondary schools (Kurikulum Baru Sekolah Rendah and Kurikulum Baru Sekolah Menengah) governed by the Ministry of Education. Number of courses or subjects required determine the number of classes and type of classroom (i.e: music room, laboratories, halls or outdoor space/areas, etc).

Commonly, layout of standard schools is arranged in linear spatial organization with one sided corridor. Two blocks of three or up to five stories block are facing each other with a courts in a middle. Two blocks that faced each other are connected with a bridge where shared staircases are designed in the middle or merely just a bridge for connectivity. Fire staircases are located either in the middle or at the end of the block, while toilets are always located at the end of the block. Other blocks for halls, laboratories, workshop, canteen, musholla are another separated physical building form. These are basic architectural form and spaces which are required by a school to accommodate subjects such as science, mathematics, geography, history and religion. Gardens are used more like yards or working compound for specific subjects such as science or vocational landscape or co-curriculum activities. The existence of green surrounding is not emphasizing as maintenance to keep it clean, manageable and safe for the children can increase maintenance budget for the school.

The environment and the physical surrounding of public schools do not really encourage the learning through nature or school as 'third teacher' or a laboratory for the green and sustainable living experience.

## **ISSUES AND PROBLEM**

To develop physical form and space of an existing school to accommodate green design strategies is a challenge. In green school program students are required to connect with nature, however the layout and space planning of school design not allowed much freedom to allocate space for such activities; to grow plants, to keep and manage recycle materials and to process composite. The landscape of school complex is commonly laid with concrete or tarmac for easy maintenance. In a hot humid country such as Malaysia to have a well maintained green landscape is not an easy task. The hardscape surrounding has increased the temperature and bring glare and heat which make it uncomfortable for students

and staff. Study have shown that the environment of teaching and learning has tremendous effect on academic performances. Environmental factors has affected 73% of the score in student scores (“School Design, Classroom Layout”, 2013).

### **AIM AND OBJECTIVES**

The study attempts to propose a suitable design of school physical form and space in order to use school as the living laboratory in motivating green initiatives in school. The proposed design evaluated based on the optimum recommendation of of the school will be based on the site and building planning, climate, and green technology application.

### **METHODOLOGY**

A design thesis proposal (Mazlan, 2016) is presented as an experimental process in searching for the suitable green school form and space layout. The analysis is focussed on creating a comfortable environment due to climate and placing green technology application.

### **GREEN SCHOOL CRITERIA**

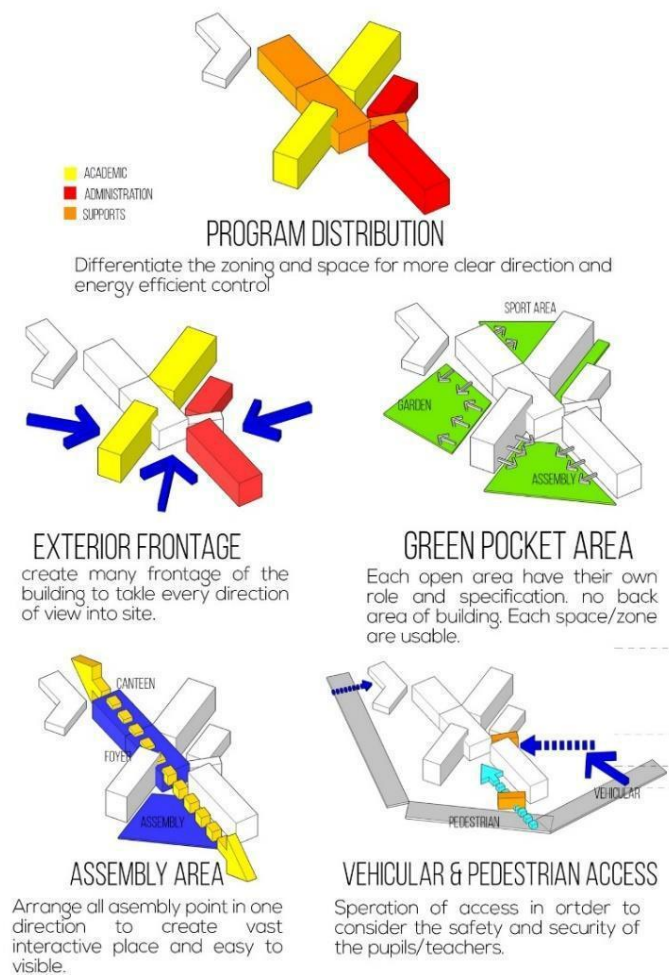
Teaching and learning environment has tremendous effects on students’ performance (Higgins, Hall, Wall, Woolner, & McCaughey, 2016; Schneider, 2002). The world has realized that by establishing a green school or eco school program, the teaching and learning environment which are based on nature will change the future education paradigm. Eco or green school is an international programme that lead to sustainable development. Study shows that green school program can reduce absenteeism and increase test score (US EPA), 2017).

In the eco or green school program, each school is recommended to apply six themes: 1. Waste and litter, 2. Water, 3. Energy, 4. School Grounds, 5. Nature and Biodiversity and 6. Climate and Change. It is not easy to apply all, most green school interpret the six themes into application of green technology such as install photovoltaic solar panel, harvest rainwater, recycle waste and reuse material, plant trees and grow edible plants for usage. Case studies done in this region shows that Green school in Bali, Indonesia is the best green school example (Denan et al., 2017).

## GREEN SCHOOL DESIGN CONSIDERATION

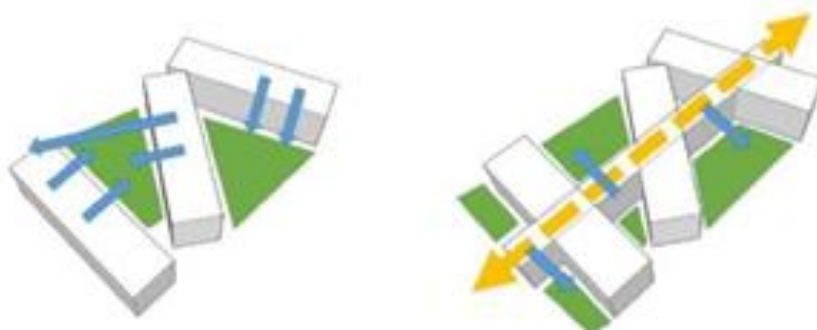
### Site Planning

In searching for a conducive and comfortable learning and teaching environment, passive design concept is emphasized. Not only site planning focus on accessibility, security and maximization of space on site, but building orientation is also considered due to avoid over exposure to heat and sun. Figure 1 shows the site planning process in searching the best orientation based on program distribution (academic, administration and services), exterior frontage, green pocket areas, assembly area and vehicular and pedestrian access.



**Figure 1(a): Site Planning and Design process**  
 Source: Mazlan (2016)





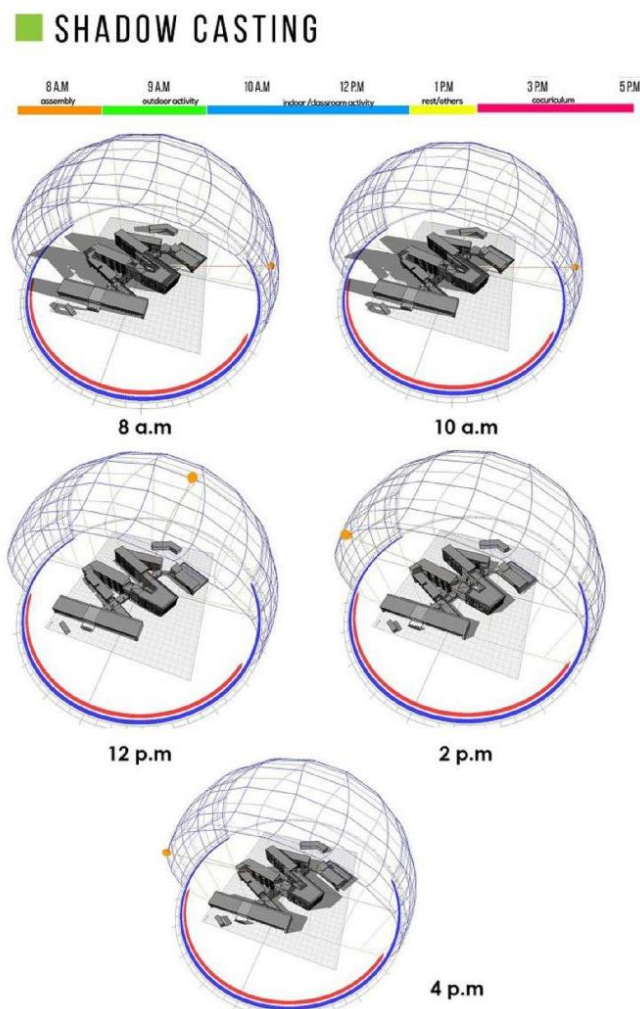
**Figure 1(b):** Site planning with green pocket and middle spine for connectivity in between blocks.

### **Passive Design**

Passive design feature is one of the strategy to achieve green and sustainable design. Orientated the longest façade building facing the south and north, the building has less exposure area toward direct sunlight. It will reduce the heat absorb to the building. Besides that, creating a proper positioning of the building based on the sun orientation will create a shadow in the area where pupils mostly have their assembly. Shadow, solar radiation and day lighting analysis are among suitable evaluation to determine design components that response to the climate, in this case the humidity of Malaysia. The evaluation will also influence the installation of green technology such as solar photovoltaic panel and rain water harvesting.

### ***Shadow Casting Analysis***

The intention of the designer is to design based on the student movement which the shaded area occur based on the student activities. For example, assembly area in the morning area shaded for the student during daily morning assembly while during evening, shaded area have moved to the sport zone where the student did not expose too much to sun radiation during co-curriculum activities. The shadow casting (Figure 2) shows the spine of the building is shaded all the time. It was a good place for the people to conduct an event or activities all day during school time. The shaded spine allowed the student to play and learn at the outdoor area.



**Figure 2:** Shadow casting Analysis  
*Source: Mazlan (2016)*

### ***Solar Radiation Analysis***

Thus, all of these strategies not only apply in the design theoretically but it has been proved by the simulation using the ecological software itself. Herewith the analysis done to the proposed eco-school building; the solar radiation analysis showed that most of the roof were the most exposed area to the direct sunlight with average daily radiation is more than 6kwh/m<sup>2</sup> (Figure 3). It is the amount they received every day. On the other hand, all the school block showed they only received 0.6kwh/m<sup>2</sup> to the surface of the building. Its showed that that building

was getting less heat from direct sunlight. The result also showed the suitable spot to place photovoltaic solar is on the roof.

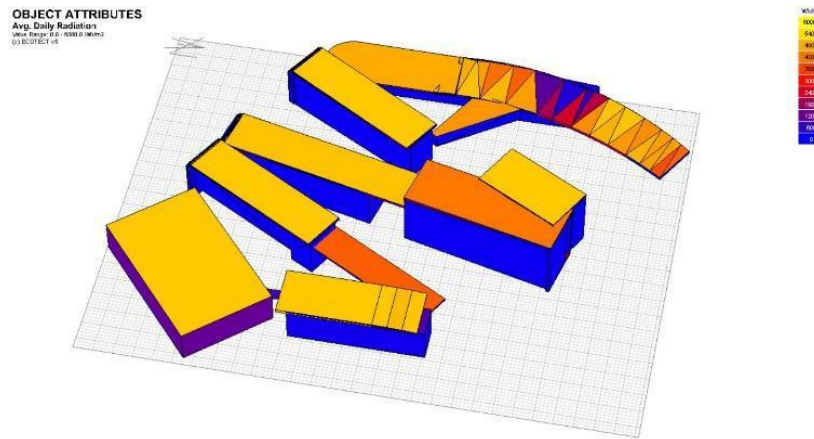


Figure 3: Solar radiation analysis of the building

#### Daylighting Analysis

The result showed that the area between the block receiving almost 70% of natural lighting in the area. It was proved that the area had ample natural lighting for reading and not required artificial lighting in the area. The garden between the block would received enough natural daylight for the plants and trees. However, spine of the building only received 60% of daylighting. It was still good enough to have an activity in the area because they were more shaded than the landscape or the garden area. Therefore, the area surrounding the building had ample daylighting to hold activities outside the classroom.

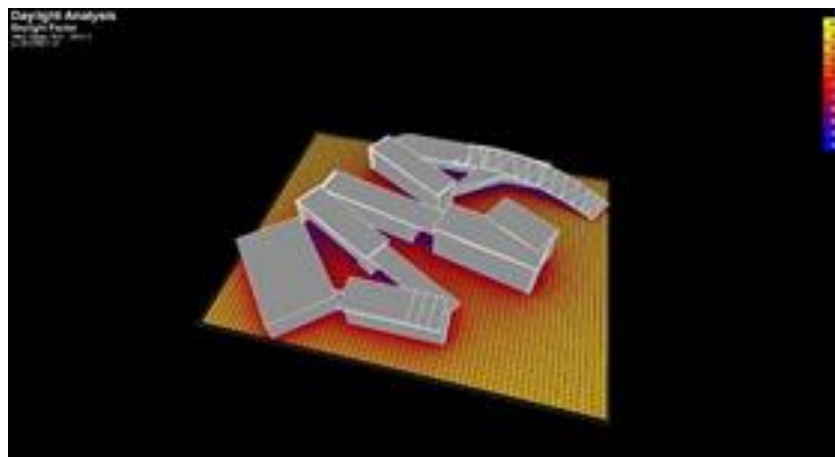
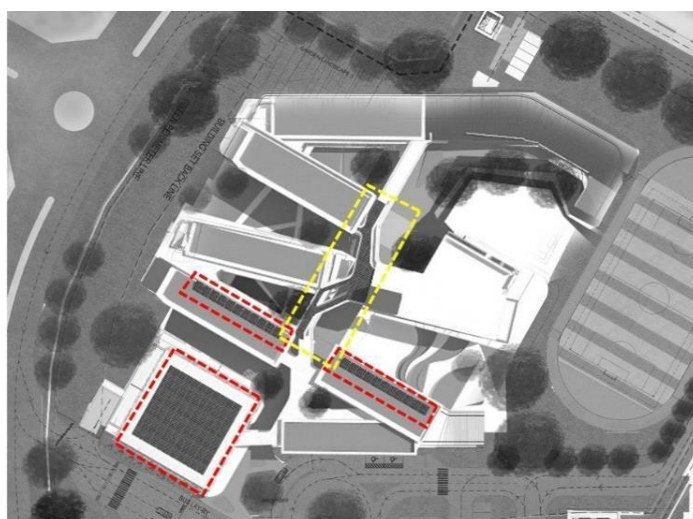


Figure 4: Daylighting analysis result of the building

## Green Technology

### *Photovoltaic (PV) Solar Panel*

The proposed design responded to the sun orientation. The roof of each block is facing more toward south to gain more exposure hours of the sun. There are no obstacle that prevent direct sunlight to the PV panel. Figure 5 shows the most suitable roof location after taking into consideration of the angle and azimuth in order to gain more exposure hours of direct sunlight to generate more electricity energy. The area only at Academic 1 block, administration block, hall, and the spin roof.

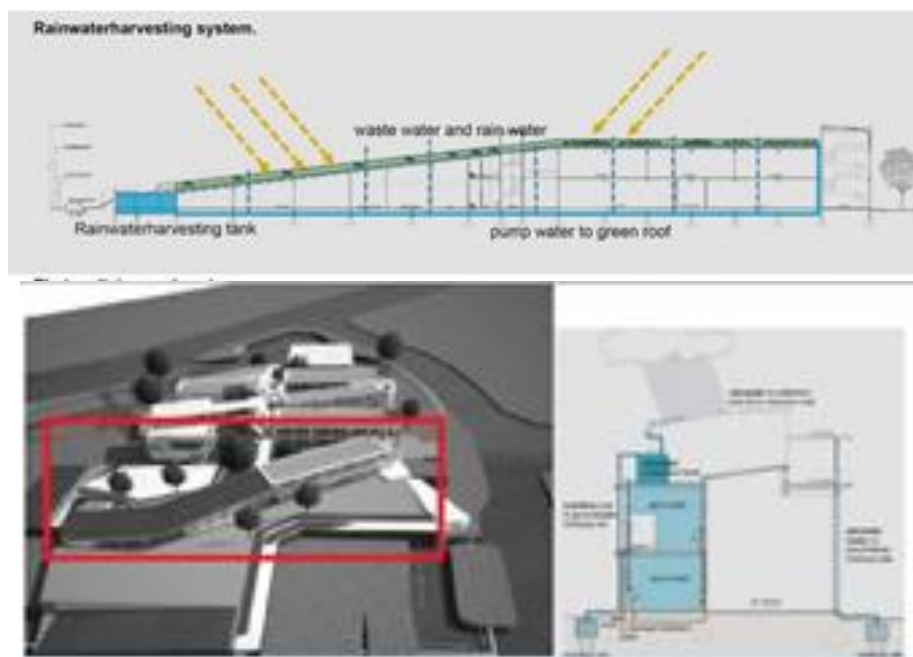


**Figure 5:** The area of PV panel location. The red one is for the commercial use while the yellow one is for the educational purposes.

*Source: Mazlan (2016)*

### *Rainwater Harvesting*

The usage of rainwater harvesting in green/eco-school is to collect all the rainwater into the one area before use it to water the garden and edible yards. This will reduce cost of water expenses and enhance the green surrounding and beautiful landscape. The rain water collecting system will be placed in each green roof intensive or extensive and at the garden roof in the canteen. The diagram below shows how the rainwater system operates and locate in the garden roof and green roof in green school (Figure 6).



**Figure 6:** The diagram of rainwater harvesting system for the garden roof and its location in the school building.

Source: Mazlan (2016)

### Details on Classroom Design

The dimension of typical classroom was adjusted. The typical classroom dimension is 7500mm x 9000mm which is equivalent to 68 sqm. A dimension of green classroom is 8000mm x 12000mm equivalent to 90 sqm. The classroom floor plate was designed bigger but thinner in order to allow more air flow ventilated through the classroom. Besides that, the green classroom was to create more room for the student in order to make the classroom 1:35 or 1:40 ratio rather than 1:30. However the size of the classroom could be adjusted depends on the size and no of occupant of the school but maintaining the ratio of classroom dimension. Figure 7 below show the eco classroom concept and its simulation.

The garden corridor was one of the area/space for children of student to take a rest between 2 period subjects. The corridor was provided with planter box for children to plant their own plant. It was one of the environmental education program (EE) which was one pot one children program.



**Figure 7:** Classroom design with green corridor.

## RESULTS AND FINDINGS

The proposed design has taken into consideration the most crucial factors such as site planning, climatic consideration, and green technology application. These have formed a unique design with blocks orientated in a zigzag layout to avoid over exposure to the sun and its heat and at the same time creating green pockets for outdoor activities which are shaded. The blocks orientation also offers good location for the PV solar panel to be laid on the roofs. Having a spine connected to the end block provides a conducive space for student's assembly and as part of roof top platform for rain water harvesting system. Other detail features such as green balcony and wall and garden plots at the back of the blocks are supporting strategies which will enhance the green school activities and image (Figure 8).





**Figure 8:** Elevation of the whole school block showing the image of green school

## CONCLUSION

The design shows that a comfortable teaching and learning environment that is based on climatic analysis and recommended green strategies proposal have high potential to be adopted as an option to a refreshing and stimulating teaching and learning environment for public school in Malaysia. No extreme design is proposed as to keep the maintenance low and safety of the children are under control.

## REFERENCES

- Denan, Z., Awang, A. H., Mazlan, M. A. H., Majid, N. H. A., Rahim, Z. A., & Sanusi, N. A. Z. (2017). The implementation of environmental education and green programs in schools to achieve sustainability. *Advance Science Letter*, 23(7), 6261-6265.
- Higgins, S., Hall, E., Wall, K., Woolner, P., & McCaughey, C. (2005). *The impact of school environments: A literature review*. University of Newcastle.
- Mazlan, M. A. H. (2016). Proposed eco school, Desa Park City (Unpublished Thesis). IIUM, Malaysia.
- Roslizar, A., Alghoul, M. A., Bakhtyar, B., Asim, N., & Sopian, K. (2014). Annual energy usage reduction and cost savings of a school: End-use energy analysis. *The Scientific World Journal*, 1-8. <http://doi.org/10.1155/2014/310539>
- Schneider, M. (2002). *Do school facilities affect academic outcomes*. Washington USA: National Clearinghouse for Educational Facilities.
- School Design, Classroom Layout Can Heavily Affect Student Grades, Learning: Study (2013, March 1). Retrieved from [https://www.huffingtonpost.com/2013/01/03/school-design-student-grades\\_n\\_2404289.html](https://www.huffingtonpost.com/2013/01/03/school-design-student-grades_n_2404289.html)
- United States Environmental Protection Agency [US EPA] (n.d.). Overview of design and construction for a healthy school environment. Retrieved October 10, 2017, from <http://www.epa.gov/schools-healthy-buildings/overview-design-and-construction-healthy-school-environment>.



**PLANNING MALAYSIA:**

*Journal of the Malaysian Institute of Planners*

**VOLUME 16 ISSUE 2 (2018), Page 63 – 74**

## **A PARAMETRIC APPROACH FOR THE STUDY OF HEAT FLOW BETWEEN STREET CANYON AND THE ATMOSPHERE**

**Muhammad Abu Eusuf<sup>1</sup>, Wira Mohd. Noor Salleh<sup>2</sup>, Abdullah Al Mamun<sup>3</sup>,  
Adnan M.<sup>4</sup>, MSR Sabeek Eusuf<sup>5</sup>, Ataur Rahman<sup>6</sup>, & Mansor Ibrahim<sup>7</sup>**

<sup>1,2,3,4,6</sup>*Kulliyah of Engineering*

INTERNATIONAL ISLAMIC UNIVERSITY MALAYSIA

<sup>5,7</sup>*Kulliyah of Architecture and Environmental Design*

INTERNATIONAL ISLAMIC UNIVERSITY MALAYSIA

### **Abstract**

This paper presents the investigation results of the convective heat flow behaviour among the top of an urban street canyon and overlying atmosphere using a numerical model together with available field measurement data in variable geographical and meteorological conditions. It finds that the heat flow structure characterizes the street canyon have a strong relationship with narrowness index, outside wind velocity and latitude of the study area. The increase of the narrowness index and consequently, reduction of the sky-view factor leads to the diminution of heat flow exchange. The temperature of canyon surfaces in smaller narrowness index (n) decreases quickly to the lower degree than the temperature of the surface with larger (n) one. The increase of wind velocity outside of canyon makes this convective heat exchange flow higher, and cooler the street canyon. A parametric approach was established to evaluate this convective heat exchange flow based on the narrowness index, the latitude of the city and outside wind velocity.

**Keyword:** street canyon, narrowness index, convective heat flux

<sup>1</sup>Associate Professor at International Islamic University Malaysia. Email: eusuf2005@gmail.com



## **INTRODUCTION**

Urban climate research has been carried out in two distinct scales: urban boundary layer (UBL) and urban canopy layer (UCL) (Oke, 1981). At the mesoscale, the UBL derives many of its characteristics from the interaction with the UCL beneath (Swaid, 1990), which extends vertically between the levels of zero net heat flux in the ground up to an arbitrary upper level, which is a fictitious surface, known as an urban lid and situated slightly above the roof level (Swaid & Hoffman, 2010). Within this level, all the structures at the urban surface contribute to the energy storage.

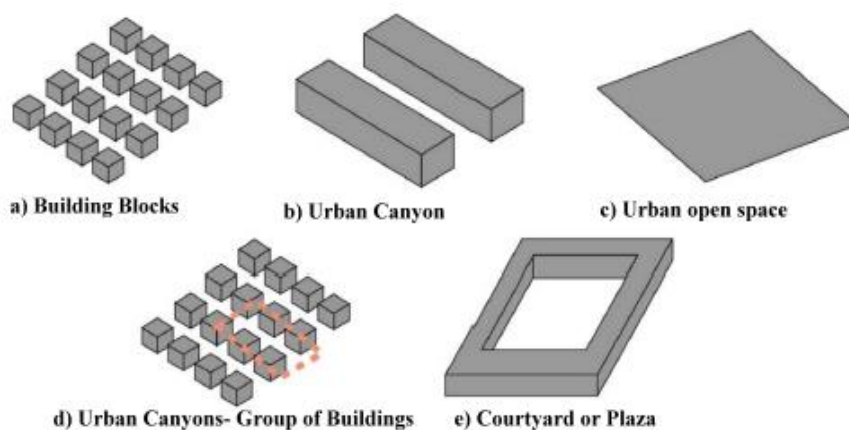
The complexity of the UCL generates an unlimited number of microclimates that prevents its study at city-scale. Thus, instead of studying the whole UCL, in the microscale the smallest division, which has common structural characteristics known as urban street canyon, is investigated. Fig. 1 shows the different geometrical aspects. Some studies have addressed the problem of heating characteristics of the canopy layer; especially the street canyon and then significant results have achieved (Yoshida, Tominga, & Watatani, 1990; Mills, 1993; Oke, 1981; Nunez & Oke, 1977; Sharlin & Hoffman, 2004; Swaid & Hoffman, 2011; Swaid & Hoffman, 2010).

The top of UCL yields the lower boundary conditions for any model of the overlying UBL. To study the thermal characteristics at city-scale, heating characteristics of the canopy layer and heat exchange between this layer and the overlying atmosphere must be well understood. However, in a numerical model for the urban climate, to give a detail resolution in the canopy layer, the grid meshes in the horizontal direction must be much smaller than the width of the urban canyon. This usually prohibits the application of the model to a large scale due to the limitation of computational facilities. Thus, large grid meshes in the horizontal direction and enables the study of the urban thermal climate at the scale of a city. It is, therefore, evident that the quantification of the exchange processes between the top of the UCL and the overlying atmosphere at the lowest computational cost is of vital importance.

This study also attempts to provide a quantitative estimate of the convective heat exchange between the smallest division of the urban canopy layer and the overlying atmosphere through a parameterization scheme based on observed data and a numerical model.

## HEAT FLOW AND CHARACTERIZATION ON STREET CANYON

Studies have revealed that the main reason for the modification of heat flow is the reduction of the fraction of the bare soil surface and the increase of paved or covered surfaces in the urban area (Yazid, Sidik, Salim, & Saqr, 2014). Generally, for an unpaved natural ground surface, a significant portion of the net incoming radiation is converted into latent heat by evaporation & evapotranspiration (Asaeda & Vu, 2000) and as consequences minimal heating of the soil surface and that influence the reduction of subsurface heat storage and then convective heat exchange between the soil surface and atmosphere is small. In this case, the reheating of the atmosphere by convective heat released from the ground surface is present only during the solar hour. After sunset, surface temperature decreases quickly and soon becomes lower than that of the atmosphere. Nocturnally, the downward transfer of the convective heat from the atmosphere to the ground surface leads to the cooling of the atmosphere by the ground surface (Asaeda & Vu, 2000). But the situation is entirely different for a paved or covered surface. During the solar heating time, paved surface absorb a huge amount of solar insolation and since no evaporation can occur, the surface temperature becomes significantly higher than that of the overlying atmosphere. Due to higher surface temperature created more convective heat exchange between the canyon surface and the atmosphere and emitted higher net upward infrared radiation from the surface, modifying air temperature in the urban area compared with that in the rural area. Besides, the high conductivity of the pavement material helps to store a significant amount of heat flow (Asaeda & Vu, 2000).



**Figure 1:** Different Urban geometrical aspects in studies  
*Source: Toparlara, Blockena, Maiheub, & van Heijstd (2017)*

The subsurface storage heat is released to the atmosphere nocturnally in the form of convective heat and upward infrared radiation. The complexity of the

urban surface represented by urban structures can reduce the sky-view from the surface, thus trapping portion of infrared radiation emitted by the surface, and making surface temperature even higher. Hence the temperature of the atmosphere above an urban surface is higher than that above the rural surface not only during the day, but also at night.

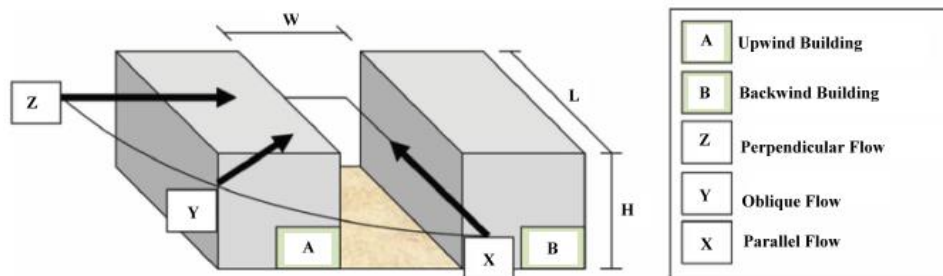


Figure 2: Geometry and flow characterization of Urban Street Canyon

Source: Yazid et al. (2014)

This phenomenon is known as the urban heat island (Oke, 1981; Toparlara et al., 2017) and the difference of the air temperature with surrounding rural area is called urban heat island intensity the underground heat storage, and paved surface temperature is different for different pavement materials and canyon geometries (Vu, Asaeda, Ito, & Armfield, 1994; Oke, 1981; Nunez & Oke, 1977; Swaid & Hoffman, 2011; Yazid et al., 2014) (Figure 2). Heating processes in a street canyon area very complicated due to the complexity of the wind field and the radiation condition due to the change of skyline and which affects the duration of sunshine and radiate interaction occurs between a building and front streets. Also, surfaces in a street canyon can absorb the incoming direct and diffuse solar radiation together with short-wave radiation reflected and infrared radiation emitted by the surrounding environments. This interaction is determined by narrowness index of a street canyon, which is the ratio between the average high of buildings at both sides of the street canyon and width of the street. The physical environment can change with the narrowness index, and this leads to alterations of heat energy exchange and thermal conditions. The increase of the narrowness index leads to: (i) a smaller fraction of a surface sunlit; (ii) smaller downward diffused short-wave; (iii) reduction infrared radiation to the surface in a street canyon. Consequently, the canyon surface becomes cooler during the day, which results in it smaller convective heat flow interchange among the street canyon and the overlying atmosphere. However, a street canyon with high narrowness index can trap massive portion of the infrared radiation emitted by its surfaces and slow down cooling processes after sunset. Studies have revealed that wind blowing over a street canyon creates eddies inside the street canyon whose number and intensity depends on the narrowness index (Vu

et. al., 1994). It is clear that all of the factors as mentioned above must consider for the study of the canyon heating processes.

## **FLOW OF MATERIALS**

### **Field Observations**

Field observations were carried out at IIUM Gombak campus, Selangor, Malaysia, 3.2513°N, 101.7362°E, to study the heating characteristic of street canyons. The observational site was near the Rectory building (known as Imam Gazzali Street - a street canyon). The narrowness index of street canyons varies between 2 to 3.0, with the North-south orientation.

During the observation, the metrological parameters were measured at 2m height using hand-held KANOMAX CLIMOMASTER 6511 with the accuracy of  $\pm 1\%$ . The sampling and recording rate for the sensor is 1 minute. Other parameters such as Albedo, surface temperature, etc. were also measured. Observations were carried out from January to December 2014. The weather conditions were varying from sunny, cloudy and rainy days. Since the purpose of this paper is to validate a numerical model and construct a Parametric approach between Street Canyon and the Atmosphere and the data observed from July 7<sup>th</sup> were used to attain this validation

A sketch of the observational area and points are represented as shown in Figure 1 and Figure 2, were different geometry and flow characteristics are with various narrowness indices and orientation. Figure 2 depicts geometry and flow characteristics urban street canyon include upwind and backwind building, x-y-z flow.

As can be seen in the figure, the day was hot and sunny where air temperature and solar influx reaching more than 33°C, close to 800 W/m<sup>2</sup> and 150 W/m<sup>2</sup> as incident and reflected radiation at noon, respectively. The meteorological conditions from 8 a.m. to 8 p.m. varies in the range from 23- 33o, 85.4% to 82.8%. This hot and humid weather is typical during the tropical (dry) Kuala Lumpur area. Figure 3 describes the observed diurnal solar influx: incident (Si) and reflected radiation (Sr).

In order to investigate the behavior of convective heat exchange between the street canyon and the boundary layer above, heating characteristics of street canyons with different narrowness indices must be investigated. However, a huge amount of observational data would be needed for this purpose. Being, a very costly and time- consuming task and basically challenging to implement in practice.

### **Numerical Model Description**

The numerical model employed in this study is the same as that of Vu et al. (1994). In this model the temperature of walls and road surfaces in a long, straight street canyon is computed by solving the one-dimensional heat conduction

equation (1) as follows:

$$\rho c \frac{\partial T}{\partial t} = k \frac{\partial^2 T}{\partial z^2} \quad (1)$$

The boundary conditions at outsides surfaces of walls and road are the energy balance equation:

$$-k \frac{\partial T}{\partial z} = S(1-\alpha) + R_{Ln} - H \quad (2)$$

Where,  $\rho c$  is the volumetric heat capacity of the surface material;  $k$  is the thermal conductivity of the surface material;  $T$  is the surface temperature;  $S$  is the total short-wave radiation to the surface;  $\alpha$  is the canyon surface albedo;  $R_{Ln}$  is the net infrared radiation to the surface and  $H$  is the convective heat flux. The temperatures inside the buildings and at depth are considered constant.

To compute the fabric (walls and road) temperature, the street canyon is divided into many horizontal and vertical elements<sup>4</sup>. Then, for each element, equation 1 is discretized in the normal direction to the element surface using a finite difference Crank-Nicholson scheme.  $R_{Ln}$  is estimated from the following equation (3)<sup>9</sup>.

$$R_{Ln} = \varepsilon_i \sigma \left[ \sum_{\substack{j=1 \\ i \neq j}}^N \varepsilon_j \psi_{ji} T_j^4 + \varepsilon_a T_a^4 \psi_{sky-i} - T_i^4 \right] + \varepsilon_i \sigma \sum_{\substack{k=1 \\ k \neq i}}^N \sum_{\substack{j=1 \\ j \neq k}}^N \psi_{ki} (1 - \varepsilon_k) \psi_{jk} T_k^4 \quad (3)$$

Where  $i$  is the receiving surface temperature,  $j$  and  $k$  are the emitting surface elements to  $i$ ,  $T_j$ ,  $T_i$ ,  $T_k$  and  $\varepsilon_i$ ,  $\varepsilon_j$ ,  $\varepsilon_k$  are the temperature and emissivity of surfaces of elements  $i$ ,  $j$ ,  $k$  respectively, and  $\varepsilon_a$  is the atmospheric apparent emissivity,  $T_a$  is the temperature outside the canyon and  $\psi_{sky-i}$  is the view factor of  $i$ th element for the sky and  $\psi_{ji}$  is the view factor of surface element  $i$  for surface element  $j$ . The last term of the eqn. (3) is assumed to be negligible in the 2-D canyon analysis; the first and second terms are incoming infrared radiation from the surface; and the last term is that of alternate regions. The convective heat flux  $H$  from an element  $i$  is estimated by the equation 4<sup>3</sup>,

$$H = h_c (T_a - T_i) \quad (4)$$

In equation 4, the convective heat transfer coefficient  $h_c$  is estimated as<sup>3</sup>:

$$h_c = 0.99 + 0.689u \quad (5)$$

Since the purpose of this work is to establish a parameterization scheme which permits the evaluation of convective heat exchange between the street canyon and outside atmosphere, wind velocity outside the street canyon  $u$  should be used in equation 5 (Nunez & Oke, 1977).

To verify the applicability of the model for the simulation of the heating processes in a street canyon, the model was used to compute temperature at wall

and road surface at the observational site. The model has also been used to compute surface temperature in an east-west oriented street canyon for the observations reported in Yoshida et al. (1990).

## RESULTS AND DISCUSSION

### Diurnal Variation of Heat Influx

Figure 3 depicts the comparison between computed and observed diurnal variations of heat fluxes within the North-South oriented street canyons with the conditions reported in Yoshida et al. (1990). The convective heat flux at the top of the canyon  $H_c$  is estimated using equation 9 in the next section; the net radiation flux  $Q^*$  is estimated based on the computed net short-wave and infrared radiation to the street canyon; and the conductive heat flux  $Q_g$  is the difference between the net radiation (Vu et. al., 1994). Figure 5 also confirms that there is a satisfactory agreement between the computed and observed heat fluxes.

All above-mentioned facts prove that the numerical model can simulate the heating processes in a 2D street canyon with reasonable accuracy.

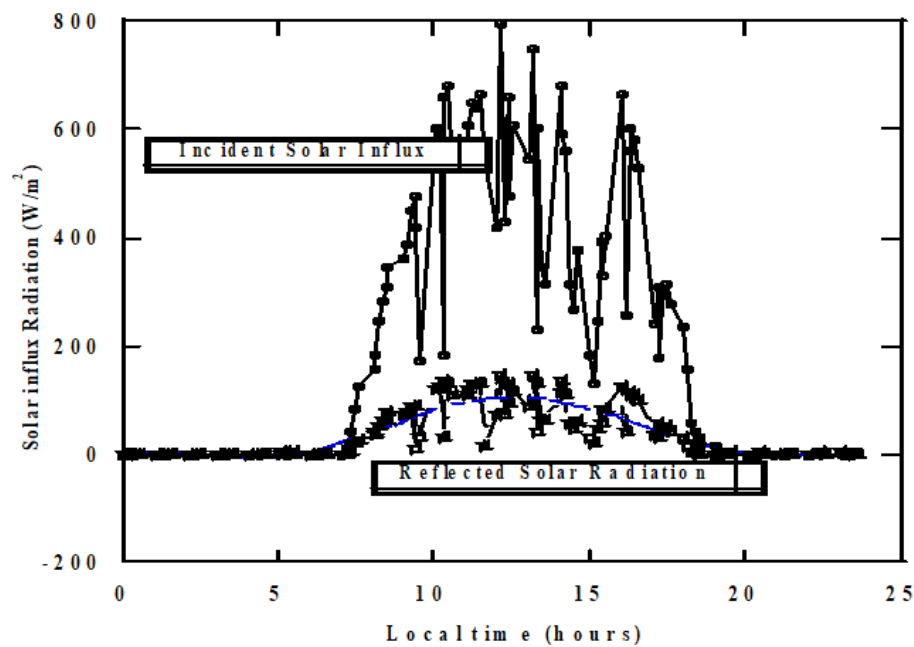


Figure 3: The observed diurnal solar influx: incident (Si-eqn 6) and reflected radiation (Sr-eqn 7)

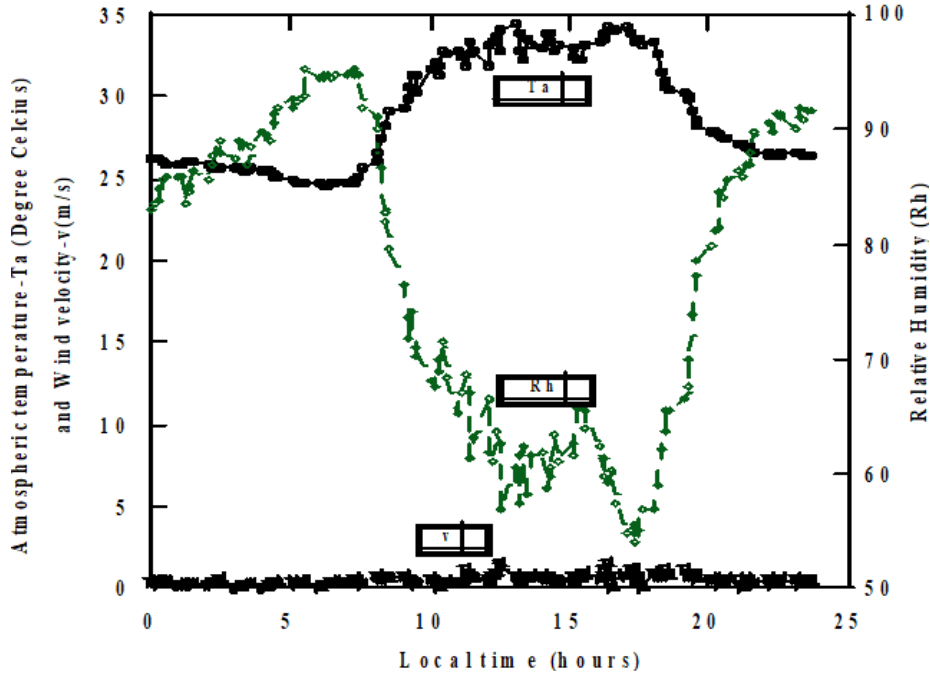
$$\begin{aligned}
 S_i &= 0.51 \times 10_2 + 0.16 \times 10_3t - 0.945 \times 10_2t^2 \\
 &\quad + 0.196 \times 10_2t^3 - 0.164 \times 10t^4 \\
 &\quad + 0.06t^5 - 0.8032 \times 10_{-3}t^6 \\
 &\quad \text{Root mean square (RMS)=90\% (A)} \\
 S_r &= 0.088 \times 10_2 + 0.301 \times 10_2t - 0.182 \times 10_2t^2 \\
 &\quad + 0.037 \times 10_2t^3 - 0.031 \times 10_{-1}t^4 \\
 &\quad + 0.1136 \times 10_{-1}t^5 - 0.1522 \\
 &\quad \times 10_{-3}t^6 \\
 &\quad \text{RMS=91\% (B)} \\
 \alpha &= \frac{\sum S_r}{S_i} \quad \text{(C)}
 \end{aligned}$$

Where  $\alpha$  in equation 8 is the albedo or solar reflectivity coefficient for urban canyon and that  $S_r$  is multiple in characteristics, but for plane location  $S_r$  is single.

Figure 4 describes the meteorological condition of the observed area. The figure also depicts the tropical characteristics of the experimental field. In general, it is expected that air temperature at a specific point in a city influences not only by physical structures immediately surrounding but also by the heating processes at more remote locations due to heat advection by local wind. Since the wind velocity at the area mentioned above is in the range of 0.3-2 m/s, thermal advection is expected in this case.

**Convective Heat Flow at the Fictitious Level**

Assuming that the energy involved in advection, canyon air temperature change and radioactive flux divergence is small in comparison with the surface sources.



**Figure 4:** The meteorological conditions of the observed area

The convective heat flux through the top of the canyon can be evaluated using the convective heat fluxes at the vertical and horizontal surface as (Toparlara et al., 2017)

$$H_t = \frac{(H_e + H_w)n + H_f}{[1 + 2n]} \quad (9)$$

Where  $H_e$ ,  $H_w$  and  $H_f$  are the convective heat flux at the east & west wall and the canyon,  $n$  is the narrowness index of canyon which is estimated as follows (Oke, 1981; Nunez & Oke, 1982)

$$n = z_b / w_s \quad (10a)$$

Where,  $w_s$  is the width of the canyon (m).  $z_b$  is the height of the building and it is estimated as follows (Yoshida et al., 1990)

$$z_b = bx_p + c \quad (10b)$$

Where  $b$  is the height of the building in meters,  $x_p$  is the number of stories and  $c$  is the height of basement floor (m).

### Parameterization of Heat Flow Structure

As presented in previous section, for a clear summer day, the convective heat flux



at the top of a street canyon strongly depend on the narrowness index, outside wind velocity, latitude of the place and time of the day, and the difference between air temperatures inside the street canyon and outside (Figure 5).

Parameterization For parametrization of  $H_t$  all factors must consider. A generalized equation for the evaluation of  $H_t$  is proposed as follows-

$$H_t = \left[ \alpha \left( \frac{1}{n^2} - \frac{1}{n_o^2} \right) \mu + \beta \right] \Delta T \quad (11)$$

In equation 11,  $\Delta T$  is the air temperature difference between the imaginary surface at the top of the canyon and outside atmosphere. This temperature difference decrease to a minimum at around 06:00 and its magnitude increases rapidly during the morning hours peaking at about 13:00-14:00 near the maximum of net solar radiation.

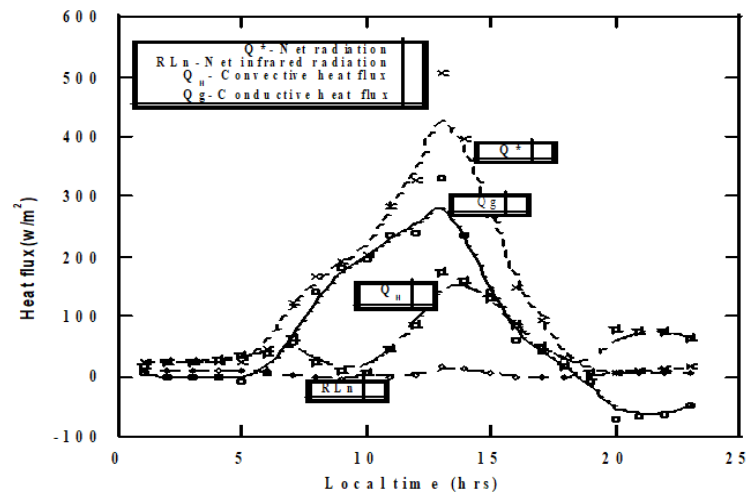


Figure 5: Parametrized the heat flow in urban canyon system

$R_{Ln}$  to the surface;  $\alpha$  and  $\beta$  are the parametric coefficients with  $\alpha = f(n, l, t, u)$  is a function of latitude, narrowness index, time and outside wind velocity, and  $\beta = f(n, l)$  is a function of narrowness index and latitude;  $n_o$  is the narrowness index where convective heat flux is equal to zero.

It is seen that parameterized results the best fit with the model and is closer to the field data than the results of equation 9 and Figure 5. This parameterization equation may apply to the real situation.

## CONCLUSION

The formulae obtained for the convective heat exchange are ready for use in any numerical model for the urban climate. Heating processes inside a street canyon

are very complicated and a numerical model for their study must account for all factors. The heat flow among the urban canyon and overlying atmosphere strongly depends on the narrowness index, latitude, time of the day and outside mean wind velocity. Our parameterization scheme has been established to formulate the relationship between these quantities. The results of computation using this functional relationship reveal that it can give a reasonable estimate of convective heat exchange between the canyon and overlying boundary layer. Since this relationship is rather simple it might be applicable for the real situation and convenient for practical use. It is expected that, in the evening, the temperature of a street canyon with small narrowness index may become lower than those in street canyon with large narrowness index. However, since no measurements were made at night, hence this assumption cannot be verified experimentally.

#### ACKNOWLEDGEMENT

This work was supported by Research Management Centre, International Islamic University Malaysia and Grant Nos. EDW-B14-175-1060.

#### REFERENCES

- Asaeda, T. & Vu, T. C. (2000). Characteristics of permeable pavement during hot summer weather and impact on the thermal environment. *Building and Environment*, 35(4), 363-375.
- Mills, G. M. (1993). Simulating of the energy budget of an urban canyon-I. Model structure and sensitivity test. *Atmospheric Environment Part B, Urban Atmosphere*, 27(2), 157-170.
- Nunez, M. & Oke, T. R. (1977). The energy balance of an urban canyon. *Journal of Applied Meteorology*, 16(1), 11-19.
- Oke, T. R. (1981). Canyon geometry and the nocturnal urban heat island: Comparison of scale model and field observations. *International Journal of Climatology*, 1(3), 237-254.
- Sharlin, N. & Hoffman, M. E. (2004). The urban complex as a factor in the air-temperature pattern in a Mediterranean coastal region. *Energy and Buildings*, 149-158.
- Swaid, H. (1990). Thermal effects of artificial heat sources and shaded ground areas in the urban canopy layer. *Energy and Buildings*, 15(1-2), 253-261.
- Swaid, H. & Hoffman, M. E. (2010). Climate impacts of urban design features for high and mid-latitude cities. *Energy and Buildings*, 14(4), 325-336.
- Swaid, H. & Hoffman, M. E. (2011). Prediction of urban air temperature using the analytical CTTC model. *Energy and Buildings*, 14(4), 313-324.

- Toparlara, Y., Blockena, B., Maiheub, B., & van Heijstd, G. J. F. (2017). A review on the CFD analysis of urban microclimate. *Renewable and Sustainable Energy Reviews*, 80, 1613–1640
- Vu, T. C., Asaeda, T., Ito, M., & Armfield, S. (1994). Characteristics of wind field in a street canyon. *Journal of Wind Engineering and Industrial Aerodynamics*, 57(1), 63-80.
- Yazid, A. W. M., Sidik, N. A. C., Salim, S. M., & Saqr, K. M. (2014). A review on the flow structure and pollutant dispersion in urban street canyons for urban planning strategies. *Simulation: Transactions of the Society for Modeling and Simulation International*, 90(8), 892-916.
- Yoshida, A., Tominga, K., & Watatani, S. (1990). Field Measurement of energy balance of an urban canyon in the summer season. *Energy and Buildings*, 15(3), 417-423.



## **HERITAGE BUILDING PRESERVATION THROUGH BUILDING INFORMATION MODELLING: REVIVING CULTURAL VALUES THROUGH LEVEL OF DEVELOPMENT EXPLORATION**

**Maisarah Ali<sup>1</sup>, Kamsiah Mohd Ismail<sup>2</sup>, Khairusy Syakirin Has-Yun Hashim<sup>3</sup>, Saifulnizam Suhaimi<sup>4</sup>, & Muhammad Hadi Mustafa<sup>5</sup>**

<sup>1</sup>*Kulliyyah of Engineering*  
INTERNATIONAL ISLAMIC UNIVERSITY MALAYSIA

<sup>2,3,4,5</sup>*Kulliyyah of Architecture and Environmental Design*  
INTERNATIONAL ISLAMIC UNIVERSITY MALAYSIA

### **Abstract**

Despite the rich and diverse heritage buildings in Malaysia, they suffer from many problems and threats. Many heritage buildings are deteriorating, and this threatens the country's cultural values. The deterioration of built heritage is a result of the poor inheritance of its related documentation and need to be addressed. Thus, this study brought forward the concept of preservation using Building Information Modelling (BIM). Exploring the potential of BIM as a preservation tool in reviving local cultural values might help to balance the problem of poor inheritance or inconsistency in managing historic and documentation maintenance. The aim of this paper is to study the relationship between levels of development (LOD) and usage of BIM in heritage building preservation. This study employs exploratory research using content analysis. The result of the study found that the availability of as-built details (LOD 500) of the building would be the crucial dataset needed for BIM to function in heritage building as H-BIM. This paper suggests on techniques available for constructing Level of Development (LOD) needed for H-BIM.

**Keywords:** BIM, preservation, heritage building information modelling, LOD

## **INTRODUCTION**

Stewardship of the built environment balances the needs of contemporary society and their impact on the built environment with its ultimate effects on the natural environment. Merging historic preservation and emerging technologies can create innumerable opportunities for reuse of the built environment, which fosters a more sustainable environment. Moreover, projects are getting more complex, and buildings are more difficult to maintain. As technology grows, there are attempts to attend this matter. In architecture, engineering and construction (AEC) industry, the significance of reliable information is paramountly important (Arayici, Egbu, & Coates, 2012). This is because the industry comprises multi-and-interdisciplinary work in achieving project success.

Historic resources are meant to be preserved for the enjoyment and the education of future generations. However, the management of records and documentation is difficult to be kept effectively (Arayici et al., 2017; Antonopoulou, 2017; Khodeir, Aly, & Tarek, 2016). Moreover, poor inheritance or inconsistently managed historic and documentation maintenance has plagued many industry players, such as preservationists. No matter what causes behind the records management issues, the problems still exist and prevalent (Del Giudice & Osello, 2013; Murphy, 2012). Inadequate records complicate and hinder preservation efforts. Time and money are often lost in search of information that previously existed but has been lost or misplaced due to unmaintained records. Such situations result in the waste of valuable resources that could be better deployed to sustain or improve a historic resource for heritage buildings which have decades of significant history and useful for a nation's development (Arayici et al., 2012; Murphy, McGovern, & Pavia, 2013; Harun, 2011). Realizing this space for improvement within the industry, technology development has brought BIM as a platform to be considered for the betterment of the industry's practice.

Building Information Modelling (BIM) is a process of digitally illustrating all the elements that composed a building (Eastman, 2009). BIM uses software which can translate the drawings into a 3-Dimensional model. In other words, the BIM process involves the assembly of 'intelligent' objects (building components and spaces) into a virtual representation of a building or facility. These consist of geometry in 2D and/or 3D integrated and associated (non-geometric) information (Arayici et al., 2012; Khodeir et al., 2016; Eastman, 2009). Therefore by using BIM, it is able to gather different threads of information related to building and construction process into a single operating environment. Fundamentally, as the information grows to nearing project completion, the level of development increases as well (Eastman, 2009).

In contrast to new building development, heritage buildings have existed for a long time where information pertaining to its design, specification, and construction are segmented in nature. The diaspora of heritage building ranges

from government buildings down to individual house owner. The risk of having an incomplete documentation and level of details to assist with their building preservation is much greater towards the individual owner. Segmentation of information, incomplete details and poor records keeping are some of the factors that affect the pursuit of preserving one cultural values in a building. The potential of BIM as a tool in overcoming this situation is observed of serving its own potential. However with an existing form and quality of information, the main question triggering this research is how does the level of development work in BIM environment for preservation purposes? Therefore drawing from this fundamental question, this paper aims to study the relationship between levels of developments (LOD) and usage of BIM in heritage building preservation.

### **BUILDING INFORMATION MODELLING (BIM)**

BIM objects are parametric, with defined rules and may automatically adjust to changes in which the information is integrated into the model in a structured way. By adding the relevant pieces of information corresponding to BIM objects (Antonopoulou, 2017; Abbasnejad & Moud, 2013), its model constitutes to a digital information resource for the built asset.

BIM supports the management of the information collected, modeled, used and shared by the different disciplines involved in the whole lifecycle process of the building. It improves availability and accessibility of all the information related to the structure, making it easier to interpret its nature, monitor its changes and document each activity related to it (Khodeir et al., 2016; Harun, 2011). Any changes and decisions made rely on the knowledge accurately formalized in the proposed model, supporting the identification of any situations, the scheduling of activities and the planning of routine management and maintenance (Khodeir et al., 2016; Hamid, & Embi, 2016; Volk, Stengel, & Schultmann, 2014).

### **Features and benefits of BIM**

BIM is an intelligent model-based process to efficiently plan, design, construct, and manage buildings and infrastructure. Most BIM software includes the following functions, which can be particularly useful in many projects (Antonopoulou, 2017; Khodeir et al., 2016; Abbasnejad & Mohd, 2013):

- as multiple design options, such as an analysis of proposed activities,
- as a clash detection, for highly accurate spatial coordination of new design with existing design
- Integration of various datasets, such as historic information, photographs, and drawings.
- integration of intangible information, such as significance and heritage values that are associated with specific components or spaces;

- interoperability, for data sharing and reuse across a multi-disciplinary team;
- Interfacing with other enterprise systems, such as GIS, websites, CMMS, and some databases system.

These benefits of BIM can lead to design consistency and visualization, cost estimations, clash detection, and improved stakeholder collaboration (Eastman, 2009; Hamid & Embi, 2016; Eastman, 1992). Valuable data inventory (dataset) such as documentation of maintenance details, product's condition, information monitoring, and space management can be developed quickly using this platform (Antonopoulou, 2017).

BIM software makes up about one-half of the components in the whole process. Therefore, the adoption BIM technology requires efficient, and less costly way of working (Antonopoulou, 2017; Azhar, Khalfan, & Maqsood, 2015). All the data needs to be formatted in the right way and available at the right time is not acting as barriers to its full adoption. The challenges are the unavailability of sufficient experts within the country, relevant equipment for practicing are scarce, limited availability of trainers, and financial-related challenges (Del Giudice & Osello, 2013; Harun, 2011; Zahrizan, Ali, Haron, Marshall-Ponting, & Hamid, 2013; Abbasnejad & Moud 2013).

These difficulties, however, should not prevent, or even discourage construction players from taking advantage on this technology advancement in different ways.

### **HERITAGE BUILDING PRESERVATION IN MALAYSIA**

In Malaysia, there are many great values and diverse heritage buildings available. According to the statistic by Jabatan Warisan Negara (2013), under Section 76, there were about 176 cultural heritage that have been listed as National Heritage in Malaysia. Although some of them have been properly conserved, many of these buildings still suffer from deficiencies, being abandoned and devalued without proper maintenance except minor repair works (Harun, 2011; Ali, Ibrahim, Haji, Yunus, & Yahya, 2016). In short, it suffers from many problems and threats.

The distribution of historical buildings in Malaysia shows more than 20,000 buildings are considered historical and worthy of conservation. Example of historic buildings in Malaysia are mosques, residential, schools, railway stations, hotels, churches, palaces, clock towers, prisons, government offices, institutions and commercials, forts and monuments (Harun, 2011).

Among the problems that exist are the Malay realm suffers from rapid destruction of valuable old traditional Malay villas and palaces that reflects Malaysian history and identity. Besides intended demolition of buildings, some other buildings suffer from partial collapsing due to their deteriorated condition. Low maintenance, mismanagement, and weakness in enforcing laws and policies are some of the deterioration reasons (Murphy et al., 2013).

The effects of time and weather conditions with the low maintenance can constitute to make the problem worse (Harun, 2011).

Experts have acknowledged that work involving heritage building is not the same as any other construction work (Ali et al., 2016). In-depth knowledge and expertise on building material and structures that cause building defects are required. This knowledge is essential to ensure that the authenticity of the building structure and the fabric is preserved while protecting the significance of the building's heritage values. This is utmost important in the process to learn about the condition of the building before any work is carried out.

BIM application on heritage buildings can provide a modeling environment which will be able to improve information management. Information management such as to ensure unambiguity, consistency, coordination, and coherence of all the knowledge are needed to fully understand the structure (Murphy, 2012). Thus, the 3-D modeling of the building in BIM platform with reliable as-built dataset will ensure this (Antonopoulou, 2017; Murphy, 2012).

Unlike the new-build construction sector, where BIM has been widely applied for a number of years at an international level (Volk et al., 2014), it is analyzed from the study that BIM for heritage assets is a new field of research in terms of adoption by heritage professionals (Antonopoulou, 2017). Therefore, this area of study is known as Heritage Building Information Modeling (HBIM) will be highlighted in this paper.

### **HERITAGE BUILDING INFORMATION MODELLING (HBIM)**

HBIM can be described as a novel system for automatically producing both visualization models and preservation of documents, for example for the recording of historic structures and their environments (Antonopoulou, 2017; Murphy et al., 2013). HBIM also avails in developing details such as the object's surface in its methods of construction by utilizing images to understand texture, massing, and form. Thus BIM can be considered as a dataset of information about the disciplines (Giudice et al., 2013; Abbasnejad & Moud, 2013; hamid & Embi, 2016). Other authors used the historic data that enable the development of the details about the object's surface concerning on its methods of construction and material finishing (Antonopoulou, 2017; Khodeir et al., 2016). Thus, HBIM can also be defined as a semantic-aware database of historical buildings, in which the geometric model is connected to descriptive multi-source information (Murphy, 2012; Long, Fleming, & Brackney, 2011; Tang, Huber, Akinci, Lipman, & Lytle, 2010).

The first step in the HBIM structuring workflow is the modelling of shapes. The next step is the semantic modelling such as recognition and categorization of objects. The final step is the modelling of relationships between the objects (Murphy et al., 2013; Tang et al., 2010). One area of interest in HBIM



is the availability of effective tools for the acquisition of suitable and accurate information for the work (Tang et al., 2010). Historical or heritage buildings are usually examples of objects with non-regular and complex geometry, unlike modern constructions which commonly have regular geometry. This has made the work for these buildings more challenging (Tang et al., 2010; Garagnani & Manferdini, 2013). Moreover, the manual generation of 3D models connected to as-built HBIM is complex and time-consuming. Nevertheless, other information such as analysis and monitoring over time (Tang et al., 2010) concerning historic construction techniques and architectural details can also be inserted as an input.

HBIM can create a database to capture information that will be beneficial (Antonopoulou, 2017; Giudice, 2013; Murphy et al., 2013; Eastman, 2009). The database can become the foundation for building decision-making tools that are capable of measuring cost reductions, cost avoidances and values added (Long et al., 2011; Garagnani, 2013). Therefore the digital collaboration and efficient information management technology of HBIM can also allow active stakeholders involvement.

HBIM allows for improvement in spatial coordination (Volk et al., 2014) and assessment of design options under various scenarios. This is significant in the case of historic assets, where any change in the historic fabric must be carefully considered and justified. It can also provide a review of the building's exterior and interior (Volk et al., 2014). More importantly, it facilitates the availability to survey renovations and changes.

The purpose of developing these preservation documentation require the highest level of accuracy especially in the specification of the detail (Long et al., 2011; Worell, 2015), such as HBIM which used historic data to recreate the past or to restore historic artifacts and buildings (Abbasnejad & Moud, 2013; Eastman, 1992). HBIM focuses on the emergence of architectural pattern books to define architectural rules and detail. Besides the presentation of a narrative, HBIM can illustrate the evolution and form of classical architecture for computer-based modelling (Murphy, 2012).

### **LEVEL OF DEVELOPMENT (LOD)**

The level of maturity in HBIM approach is described as the Level of Development (LOD) which endeavors to address that model elements develop at different rates during the design process (NATSPEC, 2013). LOD defines the extent to which model elements have been developed, from conception in the mind of the designer through to their construction and operation (NATSPEC, 2013).

In a project management, LOD acts as a tool to serve the following purposes (Apollonio, Gaiani, & Sun, 2012; NATSPEC, 2013):

- As a standard reference for project players planning model development

- For recording the model deliverables
- For planning and coordinating project resources.
- For communicating project requirements to team members and organizing their workflow
- For monitoring progress against the project program

LOD provides visual clues about the relative development and details of model elements such as the dimension and quantities. Elements of identical appearance of various information include manufacturer, model number, serial number of the installed unit, commissioning and maintenance history (Khodeir et al., 2016). Thus, LOD is a measure of reliability applies to many forms of information. The intention of LOD is to provide clarity and certainty about the expectation of everyone involved in a model's development (Long et al., 2011), so that stakeholders can orchestrate their work with confidence (Antonopoulou, 2017; Zahrizan et al., 2013; Tang et al., 2010). As an industry standard, it avails communication and coordination of all project players (NATSPEC, 2013).

**Table 1:** LOD for BIM Model Element

LOD	Standard of Detailing	Graphical Representation	Quantity, Size, Shape, Location and Orientation
100	Conceptual	Symbol	Derived from other model
200	Approximate geometry	Generic	Approximate
300	Precise geometry	Generic	Accurate
400	Fabrication	Specific	Approximate
500	As-Built	Verified	Accurate

\*Non-graphic information may also be attached to the model of Element

In table 1, LOD describes as the level of completeness and the steps through which a model can logically progress from the lowest level of conceptual (LOD 100), approximation (LOD 200-400) to the highest level of representational precision which is as-built drawing (LOD 500). Models detailed to this level (LOD 500) have actual dimensions for use similar to as-built drawings. The model can be used by asset and facilities managers for orchestrating and recording maintenance, alterations, and additament of functions, elements and systems of the building (Antonopoulou, 2017; Khodeir et al., 2016; Abbasnejad & Moud, 2013). It is an ideal platform for maintaining building information for life cycle analysis and costing.

LOD speaks to the degree to which data around a component can be depended on for decision-making purposes at a specific point in time (Volk et al., 2014). This is the most critical idea with regards to collective working plans among consultants and stakeholders, for preservation work.

Unlike the new-build construction sector, where LOD is applied accordingly to project progress; heritage building is already existing building. Thus, in order to gain accurate data about the heritage buildings; preservationist need to work on getting the LOD 500 (Murphy et al., 2013; Tang et al., 2010; Garagnani & Manferdini, 2013; Worrel, 2015; NATSPEC, 2013).

### LOD 500 AND METHODS OF GETTING THE DETAILS

LOD 500 consists of accurate shape, form, quantity, size, location, orientation, description and dimensions of the building (Worrel, 2015; Apollonio et al., 2012; NATSPEC, 2013). In practice, LOD is sometimes interpreted as Level of Detail rather than Level of Development. However, there are important dissimilarities such as Level of Detail which is essentially how much detail is included in the model element. The Level of Development is the degree to which the element's geometry and attached information have been thought through. In this instant, the degree to which project team members may rely on the information when using the model. Thus, the Level of Detail can be thought of as an input to the element, while the Level of Development is reliable output.

For modelling purpose in developing the shape, form, and dimensions, the data and information from As-Built Drawings and other technology such as Terrestrial Laser Scanning (TLS) might be one of the possible techniques available nowadays (Worrel, 2015). These two methods are identified for its reliability of information and accuracy (Antonopoulou, 2017; Harun, 2011; Garagnani & Manferdini, 2013).

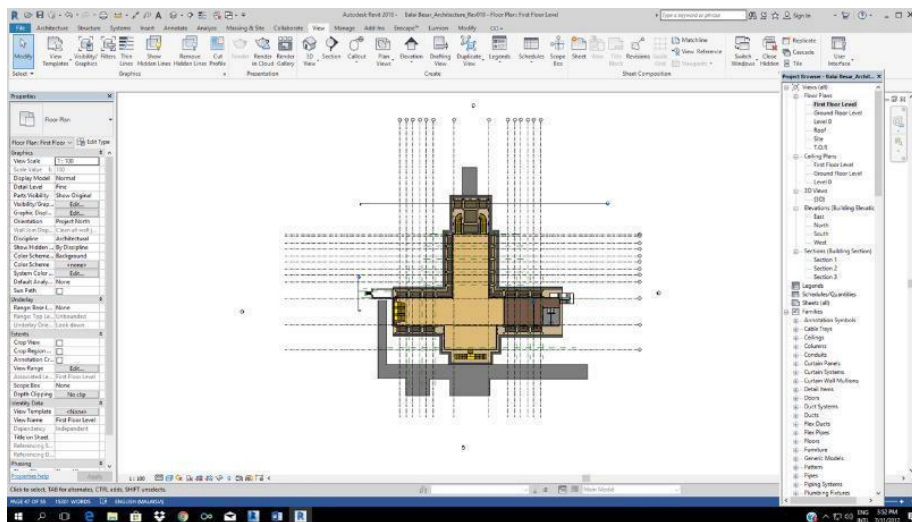
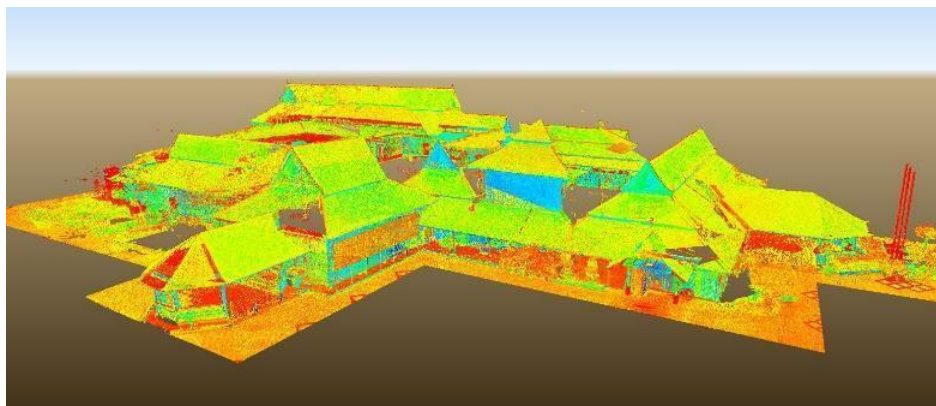


Figure 1: Extracting data and information from as-built drawings for BIM model with LOD 500



**Figure 2:** Extracting data and information from terrestrial laser scanning for BIM model with LOD 500

These two techniques guaranteed the standard of detailing is similar to as-built building. The accuracy of the details from techniques such as TLS is verified accurate by these authors (Antonopoulou, 2017; Murphy, 2012; Tang et al., 2010). Both techniques have their own benefits and disadvantages. However, this paper shall not cover on the differences because it requires comparison methodology which deserves a special discussion on that.

For HBIM, the details needed for LOD 500 will focus on the building's component form, design, size or dimension, materials and name (NATSPEC, 2013). However, additional information such as manufacturer's details, orientation, description, cost and other relevant parameters must be inserted if needed. For this study, LOD 500 showed accurate and reliable information to which project team members can rely upon model.

## CONCLUSION

Those in the preservation field know that without adequate historic and maintenance documentation, it is hard to make appropriate decisions for a historic resource. The exploration on how HBIM can be beneficial in heritage buildings preservation effort shows that it can offer positive growth for the sector in Malaysia. The potential benefits of using HBIM in the industry such as preservation seem to be very significant. By knowing techniques on producing LOD 500 for preservation purpose, it will be useful for heritage buildings' interpretation, presentation and simulation applications (Antonopoulou, 2017; Zahrizan et al., 2013; Eastman, 2009). It is recommended that upon completion of this information, the framework on the use of three-dimensional interface for tracking, storing historic information and managing preservation databases should be further discussed.

## **ACKNOWLEDGEMENT**

This research was supported by a grant (TRGS16-03-003-0003) from Ministry of Higher Education Malaysia (MOHE). This research is also supported by Kulliyah of Architecture and Environmental Design (KAED) and Kulliyah of Engineering of International Islamic University Malaysia.

## **REFERENCES**

- Abbasnejad, B., & Moud, H. I. (2013). BIM and basic challenges associated with its definitions, interpretations, and expectations. *International Journal of Engineering Research and Application*, 3(2), 287-294.
- Ali, M., Ibrahim, N., Haji, R., Yunus, M., & Yahya, M. R. (2016). Exploring methods of quantity measurement for heritage conservation works. *Advanced Science Letters*, 23(7), 6277-6280.
- Antonopoulou, S. B. (2017). BIM for heritage: Developing a historic building information model. S.l.: Historic England.
- Apollonio, F. I., Gaiani, M., & Sun, Z. (2012). BIM-based modeling and data enrichment of classical architectural buildings. *Scientific Research and Information Technology*, 2(2), 41-62.
- Arayici, Y., Egbu, C., & Coates, P. (2012). Building information modeling (BIM) implementation and remote construction projects: Issues, challenges, and critiques. *Electronic Journal of Information Technology in Construction*, 17, 75-92.
- Azhar, S., Khalfan, M., & Maqsood, T. (2015). Building information modelling (BIM): now and beyond. *Construction Economics and Building*, 12(4), 15-28.
- Del Giudice, M., & Osello, A. (2013, September). BIM for Cultural Heritage. XXIV *International CIPA Symposium*. September 2-6, 2013, Strasbourg, France.
- Eastman, C. (2009). Building Information Modeling What is BIM?
- Eastman, C. M. (1992). Modeling of buildings: Evolution and concepts. *Automation in Construction*, 1(2), 99-109.
- Hamid, A. B. A., & Embi, M. R. (2016). Review on Application of Building Information Modelling in Interior Design Industry. *MATEC Web Conference*, 663, 4-8.
- Garagnani, S., & Manferdini, A. M. (2013). Parametric Accuracy: Building Information Modeling Process Applied To the Cultural Heritage Preservation, XI (February), 25-26.
- Harun, S. N. (2011). Heritage Building Conservation in Malaysia: Experience and Challenges. *Procedia Engineering*. 20. 41-53.
- Khodeir, L. M., Aly, D., & Tarek, S. (2016). Integrating HBIM (Heritage Building Information Modeling) tools in the application of sustainable retrofitting of heritage buildings in Egypt. *Procedia Environmental Sciences*, 34, 258-270.
- Long, N., Fleming, K., & Brackney, L. (2011). An object-oriented database for managing building modeling components and metadata. *Proceedings of Building*

- Simulation* 2011, 2356–2362. Retrieved from <http://www.nrel.gov/docs/fy12osti/51835.pdf>
- Murphy, M., McGovern, E., & Pavia, S. (2013) Historic building information modelling – Adding intelligence to laser and image-based surveys of European classical architecture. *ISPRS Journal of Photogrammetry and Remote Sensing*, 76, 89-102,
- Murphy, M. (2012). *Historic building information modelling (HBIM): For recording and documenting classical architecture in Dublin 1700 to 1830*. Dublin: Trinity College.
- NATSPEC. (2013). *BIM and LOD building information modelling and level of development*. NATSPEC BIM Paper, (November), 20. Retrieved from [https://bim.natspec.org/images/NATSPEC\\_Documents/NATSPEC\\_](https://bim.natspec.org/images/NATSPEC_Documents/NATSPEC_)
- Tang, P., Huber, D., Akinici, B., Lipman, R., & Lytle, A. (2010) Automatic reconstruction of as-built building information models from laser-scanned point clouds: A review of related techniques. *Automation in Construction*, 19(7), 829-843.
- Volk, R., Stengel, J., & Schultmann, F. (2014) Building information models (BIM) for existing buildings – Literature review and future needs. *Automation in Construction*, 38, 109-127.
- Worrell, L. L. (2015). *Building information modeling (BIM): The untapped potential for preservation documentation and management* (Master thesis). Clemson University, South Carolina, USA.
- Zahrizan, Z., Ali, N. M., Haron, A. T., Marshall-Ponting, A., & Hamid, Z. A. (2013). Exploring the barriers and driving factors in implementing building information modelling (BIM) in the Malaysian construction industry: A preliminary study. *The Institute of Engineers, Malaysia*, 75(1), 1-10.



**PLANNING MALAYSIA:**  
*Journal of the Malaysian Institute of Planners*  
**VOLUME 16 ISSUE 2 (2018), Page 73 - 82**

## **THE BASIC CRITERIA FOR THE PROVISION OF AFFORDABLE HOUSING IN MELAKA**

**Mariana Mohamed Osman<sup>1</sup>, Muhammad Adib Ramlee<sup>2</sup>, Syakir Amir Ab Rahman<sup>3</sup> & Mansor Ibrahim<sup>4</sup>**

<sup>1,2,3,4</sup>*Kulliyyah of Architecture and Environmental Design,*  
INTERNATIONAL ISLAMIC UNIVERSITY MALAYSIA

### **Abstract**

The aim of this paper is to examine the criteria in the selection of the houses by the homebuyers in Melaka. The case study area was selected from Melaka in response to the report produced by Khazanah Research Institutes (KRI) in 2015 that claims Melaka is the most affordable state in Malaysia. This study applies the quantitative approach. The Yamane Taro 1976 sampling formula was used and 400 samples were selected. Three types of analysis techniques were utilized namely descriptive analysis, Pearson correlation and Relative Importance Index (RII). The study found that the three districts in Melaka were at affordable range for 2012 and 2014 and the income level of the household in Melaka was within the average income of Malaysia. Finally, it is anticipated that the study would give a clear picture on what are main criteria of better housing provision in Malaysia.

**Keywords:** housing price, affordable house, Melaka.

<sup>1</sup>Associate Professor at International Islamic University Malaysia. Email: mariana@iiu.edu.my

## **INTRODUCTION**

Owning a home for shelter and comfort is considered by many as a life goal and a measure of personal success (Hashim, 2010). However, the price of houses is increasing and houses become unaffordable to own. In Malaysia, the same situation occurs where house price is surging upwards, proportionately to income. Land scarcity and economic growth have often been cited as the factors that drive house price up to the point that it becomes unaffordable to the majority of Malaysian public (Hashim, 2010). As Malaysia aspires to be a developed nation with high-income economy by 2020, the housing industry needs to be adaptive and responsive to demand for special groups, especially the medium and low income earners. Cagamas (2013) proposes that the Government must take appropriate measures to ensure access to quality and affordable housing is for all. Cagamas (2013) also notes that as public purchasing power reduces, housing affordability gap has widened even further. However, Ong and Chang (2013) argues that the determining factors on the ability to purchase a property are not dependable solely on income but also by the high house price and the mortgage interest rate. Making houses affordable, especially to the lower income group is critical for poverty reduction, institution building, good governance at the local and national levels, and conflict prevention (Sohaimi, Abdullah, & Shuid, 2017). The objective of this paper is to provide an overview of the affordable housing scenario in Melaka and to determine the housing affordability index for each district in Melaka. It is hoped that the findings from this paper would contribute in making housing more affordable to the Malaysian public.

## **LITERATURE REVIEW**

Housing is one of the most vital investments that is made by individuals, as housing influence the social interactions and represent socioeconomic status. Tan (2013), and Glaeser and Sacerdote (2000) assert that high housing ownership creates a better motivation for homeowners to enhance the quality of the community and develop homeowners' connection with the neighbourhood. Hence, proper housing unit is one of the prominent requirements to ensure the needs of house as shelters and preferences in selecting home are being fulfilled. Besides that, the housing prices are influenced by demographic factors such as level of income of the individuals, the stock price, cost of capital and population expansion (Osman, Ramlee et al., 2017). The higher the demand it incurred the more houses need to be developed with the limitation resources such as land, increase of construction materials and many others. In addition, the housing location especially in the urban and attraction areas contribute to ridiculously increasing house prices. Eventually, houses were unaffordable for public to own. The increase of property value in most developed and developing countries have been alarming issues that need to be addressed and revised. Especially in



Malaysia, the increase of property value specifically in the urban centers lead inability of housing ownership.

There are several other criteria considered by home buyers in selecting their dream houses. The criteria for the provision of the affordable housing are not solely specific on housing designation but it goes beyond the physical design of the house. Such as the provision of better infrastructures and facilities that contribute to mobility of the residents. Therefore, the main idea of this paper is to provide overview by examining and identifying the basic criteria in the provision of affordable housing in Melaka. The state of Melaka is considered as the most affordable state in Malaysia with median multiple index of 3.0 (KRI, 2015; Osman, Rabe, Abdullah, Rosli, & Zainudin, 2017). This study identifies the criteria to attract people to buy properties. The criteria of housing selection relate to house prices, housing location and surrounding facilities provided.

#### **OBJECTIVE OF THE STUDY**

- a) To determine the basic elements criteria in providing good affordable housing
- b) To study the factors that contribute to housing preferences
- c) To provide recommendations and solutions

#### **METHODOLOGY**

The method used in the study was quantitative approach, which the primary source of data was from the questionnaire surveys. The criteria of samples selection include Malaysian, having a stable income and a tenant. The method of sampling was random sampling methods. The calculation of 400 samples was calculated based on Yamane Taro's (1967), and the formula is as shown below:

$$* n = \frac{N}{1 + N(e)^2}$$

where:

n = Sample Size

N = Population Size

e = Level of precision or sampling of error, which is  $\pm 5\%$

In addition, the random sampling methods was used and the type of analysis used such as descriptive analysis, Pearson Correlation analysis and Relative Importance Index (RII).

## FINDINGS AND ANALYSIS

### Socio Demography Profile

Table 1.0 illustrates the socio demography of the respondents in Melaka. There were a few basic of socio demography components that were asked and the components could also be the contributing factors for the house buyers. Most of the respondents were between 21 and 40 years old. More than 80% of the respondents were renting, did not own a property and wanted to purchase house. 50% of the respondents were between 21 and 30 years old. The age factors may contribute to the ability of the respondents to buy a property.

**Table 1:** The socio demography of the respondents in Melaka

Profile	Number of Respondents	Percentage
Age Range		
20 and Below	14	3.5
21-30	200	50.0
31-40	130	32.5
41-50	41	10.25
51-60	15	3.75
Total	400	100.0
Level of education		
Primary School	2	0.5
Secondary School	107	26.75
STPM/Certs/Diploma	145	36.25
Degree	119	29.75
Master	23	5.75
PhD	4	1.0
Total	400	100.0
Household Number		
1-2	51	12.75
3-4	189	42.75
5-6	126	31.5
7-8	31	7.75
9-10	3	0.75
Total	400	100.0
Type of Profession		
Executive/ Professional	120	30.0
Administration/Management	112	28
Technical Assistant	32	8
Retails	51	12.7
Non-Technical	40	10.0

Entrepreneur/Work Independently	45	11.3
Total	400	100.0
<b>Income Range</b>		
2,000 and Below	45	11.25
2,001-4,000	105	26.25
4,001-6,000	90	22.5
6,001-8,000	69	17.25
8,001-10,000	54	13.5
10,001 and Above	37	9.25
Total	400	100.0

The level of education influence behaviour of homebuyers. 73% of the respondents had underwent tertiary education and 27 % of the respondents had secondary education level. 36.25 % of the respondents had STPM/certificates and diploma qualification and 30% of the respondents held Degrees qualifications. Education levels influence the deliberation and preferences of the individuals' in house selections.

Most respondents (75%) had 3 to 6 household size. Household size determines the criteria or preferences of the homebuyers. Such criteria include housing size, housing type and housing comfort.

58% of the respondents worked as executive or professionals and management. 30% of the respondents were holding position as an executive or professional, while 28 % of them from management professions.

48% of the respondents earned between RM 2,000 and RM 6,000 monthly. Majority of the respondents (26%) earned between RM 2,001 and 4,000 per month. The mean income of the respondents was RM 5,904 and the median was RM 5,500 monthly. The income range influence housing selection criterion. The higher the income, the bigger the chances that respondents had to own houses, hence the more criteria would be considered, such as comfort, better surveillance and privacy.

### **Perceptions and Information on the Element Housing Criteria**

Table 2 shows the range of affordable housing price based on demographic and socioeconomic background. 90% of the respondents stated that the affordable housing price was RM 300,000 and below. Additionally, the mean affordable housing price was RM 211,070 and the median was RM 165,000. Below is the correlation between household income and housing price.

**Table 2:** Affordable house price

Price Range	Frequency	Percentage
300,000 and below	359	89.75
301,000-600,000	40	10.0

700,000 and above	1	0.25
Total	400	100.0
Mean	Median	Mode
RM 211,070	RM 165.000	RM 200,000

There was a statistically significant and moderate positive correlation between household income and housing price ( $r = .0428, = < 0.05$ ) (see Table 3). The result indicated that the higher the household income, the higher the housing price affordable to the respondents.

**Table 3:** Pearson correlation between income and price range

		household income	housing price
household income	Pearson Correlation	1	.428**
	Sig. (2-tailed)		.000
	N	400	400
housing price	Pearson Correlation	.428**	1
	Sig. (2-tailed)	.000	
	N	400	400

\*\* . Correlation is significant at the 0.01 level (2-tailed).

### Important Criteria in the Provision of Affordable House in Melaka

Table 4.0 shows the criteria in the provision of affordable housing. There were several housing criteria that were inquired and the data were analysed using relative importance index (RII) in SPSS. The purpose of the analysis was to measure the priority of the housing criteria according to the respondents. The highest RII score was House Price with RII of 0.90. Housing price was the main concern not only in Melaka but in Malaysia. Housing price were increasingly unbearable and unaffordable especially in major city areas.

The second highest RII score was Security Level with RII of 0.89 and the third highest RII score was Access to Public Facilities such school, clinic and many others. These facilities were essential to better facilitate homeowners to access better quality of life. On the other hand, the lowest RII score was Number of Bedrooms and Bathrooms and House Design with RII score of 0.82 and 0.80 respectively. In conclusion, if the houses was affordable and equipped with basic facilities and amenities, the housing designs would not be a major concern.

**Table 4:** Important criteria in the provision of affordable house

Statement	Total Weightage	RII	Rank
Type of House	3323	0.84	9
House Price	3594	0.90	1

Location of the house	3485	0.87	5
House design	3201	0.80	11
Number of Bedrooms and Bathrooms	3289	0.82	10
The Quality of Construction	3457	0.86	6
Total floor area	3392	0.85	7
Security Level	3571	0.89	2
Access to public Facilities	3518	0.88	3
Distance from working area	3505	0.88	4
Access to public transportation	3371	0.84	8

### Level of Satisfaction with the Current House

Table 5 shows the level of satisfaction of the current house. Types of House had the highest weightage score of 2993 or 0.74 RII score. Secondly, Access towards Public Facilities had 0.74 RII score. Based on the verbal interviews, most respondents mentioned that the accessibility towards public facilities were short driving distances. The respondents were also satisfied with the distance to work. However, there were several issues to be addressed such as the Housing Price as well as the Accessibility of Public Transportation connecting to the neighbourhood areas. The Accessibility of Public Transportation was least satisfied with the RII score of 0.65. Hence improvement should be made on the accessibility to public transportation.

**Table 5:** Level of satisfaction with current house

Statement	Total Weightage	RII	Rank
Type of house	2993	0.75	1
Access to public transportation	2602	0.65	12
House price	2782	0.70	11
Security Level	2855	0.71	7
Location of the house	2899	0.72	6
Total floor area	2790	0.70	10
House design	2796	0.70	9
Number of bedrooms and bathrooms	2886	0.72	5
Access to public facilities	2968	0.74	2
quality of construction materials	2837	0.71	8
Distance from work	2917	0.73	4
Overall satisfaction of current house	2953	0.74	3

### Level of Satisfaction with Public Facilities and Infrastructure

Table 6 indicates the level of satisfaction on public facilities and infrastructure of current house. The highest weightage scored is water and electricity with 3053 or RII score of 0.76. The religious facilities and education facilities also shared the same RII scores which was 0.76, but differed by the weightage scores of 3025 and 3021 respectively. In addition, the drainage system and the health facilities also shared the same RII of 0.75 but the drainage total weightage was greater compared to health facilities. The sport and recreational facilities had the least score with RII score of 0.72. In summary, the respondents were satisfied with the overall basic facilities provided in most neighbourhood areas.

**Table 6:** Level of satisfaction of the public facilities and infrastructure

Statement	Total Weightage	RII	Rank
Circulation system	2971	0.74	6
Water and electricity	3053	0.76	1
Drainage system	2984	0.75	4
Sewerage system	2948	0.74	9
Garbage disposal system	2887	0.72	11
Clinic and health facilities	2982	0.75	5
Commercial Facilities	2958	0.74	7
Playground and open spaces	2901	0.73	10
Sports and recreational facilities	2873	0.72	12
Religious facilities	3025	0.76	2
Education facilities	3021	0.76	3
Parking area	2959	0.74	8

### DISCUSSION AND CONCLUSION

The selection of housing criteria play a vital role especially to the first time homebuyers. The buyers were looking into houses that were decent to live, accommodate all the basic facilities, amenities and infrastructures. This study examine the important housing criteria based on respondents' preferences and satisfaction level on the current rental houses.

In order to encourage housing ownership, it is imperative to identify the determinants that attract individuals in buying a property (Tan, 2015). The housing price is closely related to income, education, household size and education level. It is anticipated that the suggestions made would help to minimize the current housing issues. According to the respondents, the main problem was the housing price. Housing prices were too high and were beyond respondents' ability to afford especially for those in the low and middle income groups. The housing schemes that were provided by the government were good enough to increase the number of housing ownership, yet the schemes still need to be regularly supervised.

Additionally, there should be enhancement of housing policies and regulations to be more pro poor. By increasing the construction of affordable housing and improving housing cost-effective design, housing prices would be more reasonable. Housing features could also be improved by upgrading facilities and amenities within the neighbourhood.

Affordable housing financing should be more attractive and reliable for all especially for the low income earners. The low income earners have restriction of income resources. The policy or programs that are going to improvised are anticipated to reduce the cost of homeownership through down payment and mortgage income payment. The government is urged to promote the increase in the availability of home financing by enabling the EPF fund to be more accessible to use for down payment and housing mortgage payment. The EPF process system should be simplified and integrated into all related agencies as it will ease process of application and submission of documents.

The study also shows most respondents were satisfied with the current condition of their houses. Yet, improvisation should be conducted from time to time in order to ensure that the people were happy with their living environment. Apart from that, the provision of parking spaces should also be revised especially in high-rise development. Multiple parking spaces for high rise buildings should be provided not only in high cost housing development but also for middle and low cost housing development. The accessibility towards public transportation should also be a concern by the housing developers and respective authorities. Access to public transport influence the value and the attractiveness of housing development.

In conclusion, more proactive approaches and housing strategies need to be executed to increase housing ownerships and better living environment are achieved.

## **REFERENCES**

- Cagamas (2013). *Housing the nation: Policies, issues and prospect*. Kuala Lumpur: Author.
- Glaeser, E. L., & Sacerdote, B. (2000). The social consequences of housing economics. *Journal of Housing Economics*, 9(1/2), 1-23.
- Hashim, Z. A. (2010). House price and affordability in housing in Malaysia. *AKADEMIKA*, 78 (Jan-April), 37-46.
- Khazanah Research Institute (2015). *Making housing affordable*. Kuala Lumpur: Author.
- Ong, T. S., & Chang, Y. S. (2013). Macroeconomic determinants of Malaysian housing market. *Journal of Human and Social Science Research*, 1(2), 119-127.
- Osman, M. M., Rabe, N. S., Abdullah, M. F., Rosli, N. F., & Zainudin, F. E. (2017). Housing affordability in the state of Melaka. *Planning Malaysia*, 15(1), 255-260.

*Mariana Mohamed Osman, Muhammad Adib Ramlee, Syakir Amir Ab Rahman & Mansor Ibrahim*  
*The Basic Criteria for The Provision of Affordable Housing in Melaka*

- Osman, M. M., Ramlee, M. A., Samsudin, N., Rabe, N. S., Abdullah, M. F., & Khalid, N. (2017). Housing affordability in the state of Johor. *Planning Malaysia*, 15(1), 347-356.
- Sohaimi, N. S., Abdullah, A., & Shuid, S. (2017). Housing affordability and pathway among Malaysian young professional in Greater Kuala Lumpur. *International Journal of Academic Research in Business and Social Science*, 7(2), 653-665.
- Tan, T. H. (2013). Homeownership schemes in Malaysia for first homebuyers. *Habitat International*, 36(1), 108-116.
- Yamane, T. (1967). *Statistics: An introductory analysis (2nd Edition)*. New York: Harper and Row.





**PLANNING MALAYSIA:**  
*Journal of the Malaysian Institute of Planners*  
**VOLUME 16 ISSUE 2** (2018), Page 83 - 88

## **DESIGN ELEMENTS OF HOUSES AMONG DISABLED COMMUNITY: THE SATISFACTION AND THE PREFERENCES**

**Syakir Amir Ab Rahman<sup>1</sup>, Nasriah Samsudin<sup>2</sup>, Mariana Mohamed  
Osman<sup>3</sup>, Syahriah Bachok<sup>4</sup>, & Noor Suzilawati Rabe<sup>5</sup>**

*Kulliyah of Architecture and Environmental Design*  
INTERNATIONAL ISLAMIC UNIVERSITY MALAYSIA

### **Abstract**

Home ownership creates stability and improves the quality of life of the disabled communities. As Malaysia approaches the developed status and the high – income economy by 2020, the housing industry needs to be adaptive to the demands for special groups. Universal homes incorporate universal design principles, resulting in a living environment that can be adapted to virtually any user’s long term comfort, safety and ease. The aim of this paper is to study on the preferences and level of satisfaction on design factor in owning residential property among the disabled community in Kuala Lumpur and Selangor. A questionnaire survey was conducted on a sample of 800 respondents. The respondents were selected from the disabled community, focusing on two categories of disabilities, physical and visual impairment. The outcome of this study shows that disabled people prefer houses which are complete with design that accommodates residents’ physical limitations. For design elements of their residential property, this study found that the disabled people are satisfied with the provision of ramp to access into the building, while their satisfaction on design for the low physical effort scored at seventh place. The study concludes with two housing recommendations: to provide at least the minimum requirement of universal design in all upcoming projects and to provide home modification scheme.

**Keyword:** disabled community, residential property, universal design, home ownership, preferences

<sup>1</sup>Assistant Professor at International Islamic University Malaysia. Email: syakiramir@iiu.edu.my

## **INTRODUCTION**

Home ownership or the ability to own residential property has been a goal for every Malaysian including the disabled communities. According to Coates, Anand and Norris (2015), owning a residential property provides sense of security which leads to happiness, productive and fulfilling of one's life.

As Malaysia approaches developed nation status and becomes a high-income economy by 2020, the housing industry needs to be adaptive to the demands of the special groups. Government needs to provide and plan suitable housing policies for all. Everyone shares the right to a decent standard of living. The fulfillment of human life beyond simple survival is access to adequate housing. The Adaptable or Lifetime Home is a concept developed during the 1980s in several European countries including Norway, The Netherlands and Great Britain. It is a normal dwelling intended for all kinds of households, but constructed with foresight so that it can be inexpensively transformed to fit the changing requirements of its residents throughout their lives or those of a disabled member, if so required (Nolte, 1988).

### **Design of House for the Disabled People**

Different impairment will need different types of facilities (Osman, Radzi, Bakri, & Ibrahim, 2015). Universal homes incorporate universal design principles, resulting in a living environment that can, with little difficulty and expense, be adapted to virtually any user's long term comfort, safety and ease. Among the characteristics of barrier free adaptable housing to make it become more preferable for disabled people are:

- i. It allows free access to buildings, housing units and services for people with mobility, hearing or vision limitations.
- ii. It provides adequate turning and working space for wheelchairs in housing units and public spaces.
- iii. It improves the safety of people engaged in normal daily activities.
- iv. It provides features that increase safety in emergencies.
- v. It provides features that make it easier to use and maintain the building, dwelling units and equipment.

### **People with Disability**

People with disabilities (PWDs) in Malaysia can be considered as one of the most vulnerable of the minority group in the Malaysian population. World Health Organization (WHO) and World Bank estimated that there were 15% of the world population has some form of disabilities. According to the Department of Social Welfare Malaysia, this percentage did not refer to all disabled people in Malaysia because the data were incomplete. This is due to the fact that the registration of PWDs in Malaysia was not compulsory, and was done based on a voluntary basis.

Persons with Disabilities Act (Act 685) defines a person with disabilities (PWDs) as those who have long - term physical, mental, intellectual or sensory impairments which in interaction with various barriers may hinder their full and effective participation in society. Referring to the Person with Disabilities Act (Act 685) there are seven categories of disabled people which are visually impaired, hearing impaired, lack of physical effort, learning issue, speech disabilities, mental disabilities and less effort wide.

### **Disabled Community in Malaysia**

According to Jabatan Kebajikan Malaysia or known as JKM (2016a), there are 356,677 people with disabilities registered in Malaysia as of 2015. However, as the registration was voluntary, the data was not completely reflective of the actual numbers in the country.

**Table 1:** Registration of person with disabilities (PWDs), 2013 -2015

Year	Number of cases
2013	264,448
2014	318,132
2015	365,677

*Source: JKM (2016a)*

Based on Table 1 the numbers of registered PWDs were increasing from year 2013 to 2015. There were 365677 registered PWDs in 2015. The total of PWDs in Malaysia covered 1.2% of the total population in Malaysia.

**Table 2:** Registration of person with disabilities (PWDs) by State, 2015

States	Number of cases
Johor	45,953
Kedah	32,983
Kelantan	25,947
Melaka	18,391
Negeri Sembilan	17,273
Pahang	21,946
Perak	33,020
Perlis	4,404
Pulau Pinang	22,094
Sabah	22,806
Sarawak	25,037
<b>Selangor</b>	<b>55,594</b>
Terengganu	18,281
<b>W.P Kuala Lumpur</b>	<b>20,911</b>
W.P. Labuan	1,037
<b>Total</b>	<b>365,677</b>

*Source: JKM (2016b)*

Table 2 shows the number of registered PWDs in Malaysia by states. As shown in the table, Selangor had the highest registered number of PWDs with 55, 594 while Kuala Lumpur had 20, 911 registered PWDs.

## METHODOLOGY

For the sampling method, this research was conducted by using purposive sampling. The sampling focused on two categories of disabilities which were physical and visual impairment. The reason behind the sampling selection was that approximately 90% of the worlds' visually impaired live in low-income settings (World Health Organization, n.d.). It was also because 28% of 25 to 64 year-olds with severe physical disabilities fall far below the federal poverty line - nearly four times the rate for people of the same age who were not disabled (Karaim, 2002).

Questionnaire survey was distributed to the sample size of 800 respondents from shelter homes and organization of physical and visual impairment people in Kuala Lumpur and Selangor. The researchers also went to the the related PWDs assembly and dialogue's programme, including the paralympic tournaments.

## FINDING AND ANALYSIS

### Mean Score of Preferred and Current Satisfaction on Design of House

Based on Table 3, the design of a house that encourage low physical effort scored the 1<sup>st</sup> ranked characteristic with mean score of 8.94. Provision of elevator scored the 2<sup>nd</sup> highest ranked characteristic with mean score of 8.91. The design of disabled friendly washroom scored the 3<sup>rd</sup> highest ranked characteristic with mean score of 8.78 while ramp to access the building scored 4<sup>th</sup> highest ranked characteristic with mean score of 8.58. The handrail scored a mean of 8.55 and level one bathroom or bathroom located near to main room scored a mean of 8.51. The disabled friendly kitchen design scored a mean of 8.46. Finally, the least preferred characteristic was a house with disabled friendly bedroom, with mean score of 8.44.

**Table 3:** Score of characteristic for preferred design of house

Statement	Mean	Rank
Design of house encourage the low physical effort	8.94	1
Elevator is provided for disabled person	8.91	2
Design of washroom is disabled friendly	8.78	3
Complete with ramp to access into building	8.58	4
Handrail is provided	8.55	5
Bathroom is provided at level one or near to main room for disabled	8.51	6

Design of the kitchen is disabled friendly	8.46	7
Have a bedroom designed for disabled person	8.44	8

As shown in Table 4, houses complete with ramps to access into building was ranked the highest with mean score of 5.92. The lowest mean score was the disabled friendly kitchen design with 5.02 mean score. Compared to the most preferred design element, housing design that encourage low physical effort was ranked 7<sup>th</sup> place with a median of 5.10. The result showed that the current needs of the PWDs were not fulfilled which can affect the percentage of housing ownership among the PWDs.

**Table 4:** Score of current satisfaction for design of house

Statement	Mean	Rank
Complete with ramp to access into building	5.92	1
Elevator is provided for disabled person	5.65	2
Bathroom is provided at level one or near to main room for disabled	5.62	3
Design of washroom is disabled friendly	5.55	4
Have a bedroom designed for disabled person	5.33	5
Handrail is provided	5.10	6
Design of house encourage the low physical effort	5.10	7
Design of the kitchen is disabled friendly	5.02	8

## RECOMMENDATIONS

This study found that the current satisfaction on housing design does not meet the preferences of the PWDs. Hence, two recommendations are suggested in response to the PWDs housing issues:

**i. Provide at least the minimum elements of universal design in all housing unit.**

Universal design elements are not only designated for the PWDs, but also for the aging population. Therefore, there is a need for each housing unit in the upcoming housing projects to implement at least the minimum requirement or elements of universal design. The government is urged to make this requirement as compulsory to all housing developers and efficiently implemented in the enforcement. The house should at least (i) have unobstructed width of doors with minimum width of 850mm, 900mm or more, (ii) provide ramp to access into the house and (iii) have toilet that are complete with disabled facilities such as level one toilet, suitable toilet seat, foldable grab rail, independent water supply beside toilet seat and wash hand basin at suitable height for wheelchair users.

## ii. Home modification scheme

Every day disabled individuals find that their homes need to be modified in a way that gives them easier access. These modifications make it possible for them to stay in their home and live an independent life. Home adjustments come in all shapes and sizes and can vary in cost from one manufacturer and contractor to another.

The ideas of this proposal are designated for the PWDs that already own a house but still require housing modification to cater their needs. Among the types of housing modifications that can be offered are:

- a. Change of bathroom and toilets that disabled friendly
- b. Modification of kitchen to be user-friendly for disabled people
- c. Installation of ramp, grab rails and handrails
- d. Expanding of the doorways
- e. Other modification needed by the disabled people

## CONCLUSION

In conclusion, the main characteristic to be considered in planning the house for PWDs was the barrier-free design. Based on the findings, the PWDs need affordable houses that encourage the low physical effort.

The preferred characteristics of housing design for the PWDs have been highlighted in this study. It is essential for related government or housing agencies to learn from the success and failures of other countries in improving the housing needs of PWDs' through related housing policies for the PWDs.

## REFERENCES

- Coates, D., Anand, P., & Norris, M. (2015). Housing, happiness and capabilities: A summary of the international evidence and models. *Open Discussion Papers in Economics* 81, *The Open University*. Retrieved from <https://www.econstor.eu/handle/10419/147532>
- Jabatan Kebajikan Masyarakat [JKM] (2016a). *Report on statistic of registered disabled community in Malaysia*.
- Jabatan Kebajikan Masyarakat [JKM] (2016b). *Categories of disabled community in Malaysia*.
- Osman, M. M., Radzi, F. H. M., Bakri, N. I. M., & Ibrahim, M. (2015). Barrier-free campus: Universiti Malaya, Kuala Lumpur. *Procedia - Social and Behavioral Sciences*, 168, 134-144.
- Nolte, E. A. H. (1988). *Building adaptable housing Nationale Woningraad*. Almere, The Netherlands
- Karaim, R. (2002). *People with physical disabilities*.
- World Health Organisation [WHO] (n.d.). World report on disability. Retrieved from [http://www.who.int/disabilities/world\\_report/2011/en/](http://www.who.int/disabilities/world_report/2011/en/)



## **DETERMINING HOUSING AFFORDABILITY FOR YOUNG PROFESSIONALS IN KLANG VALLEY, MALAYSIA: RESIDUAL INCOME APPROACH**

**Nor Suzylah Sohaimi<sup>1</sup>, Alias Abdullah<sup>2</sup> & Syafiee Shuid<sup>3</sup>**

<sup>1</sup>*College of Law, Government and International Studies*  
UNIVERSITI UTARA MALAYSIA

<sup>2,3</sup>*Kulliyah of Architecture and Environmental Design*  
INTERNATIONAL ISLAMIC UNIVERSITY MALAYSIA

### **Abstract**

Underprivileged young professionals in housing affordability are prone to an adverse effect on their well-being. This article empirically examines housing affordability among young professionals aged between 25 and 35 years old who work or live in Klang Valley. Young professionals in this paper refer to young graduates with at least a Bachelor's degree and are registered to professional institutions such as the Institution of Engineers Malaysia (IEM), Malaysian Institute of Architects (MIA), Malaysian Institute of Planners (MIP), and Royal Institution of Surveyor Malaysia (RISM). The aim of this study is to measure housing affordability based on residual income approach and to identify the attribute that affects young professionals' housing affordability. Adequacy of household income for monthly mortgage or rent as well as other non-housing goods is reflecting for housing affordability. Attributes namely occupation, the presence of children, household expenditure, transportation cost, vehicle instalment, education loan, and household income are analysed by using binary logistic regression. 264 respondents who are either a homeowner, tenant, or parental home resident were selected by using simple random sampling. The survey data were collected through the professional institutions respectively. The study found that only presence of children, occupation of urban planner and education loan III (not taking a loan) were insignificant to the model.

**Keywords:** young professionals, housing affordability, residual income approach, binary logistic regression

## **INTRODUCTION**

Housing affordability issues are ubiquitous in the housing market. Previous academicians emphasised on the affordability for the middle-income group (Bujang, Anthony Jiram, Abu Zarin, & Md. Anuar, 2015) and only beginning from year the 2013, housing affordability among Gen Y is discussed at the local level. Undoubtedly, Gen Y is receiving a devastating effect as their income is not parallel to the current housing price. Recent evidence reveals that new residence priced lower than MYR 250,000 in the Klang Valley is considered non-existent since 2014 (Khazanah Research Institute, 2015). The young professionals (YPs) are required to repay their education loan after six months of graduation and failure to do so will cause them to be listed to the Central Credit Reference Information System (CCRIS). Education loan is the criterion that distinguishes YPs from other young cohort who are not burdened with this debt. Simultaneously, other non-housing goods are required for sustaining the generation's well-being. Besides food and beverage, transportation possession, for instance, is seen as a necessity to meet the mobile nature of their career. Consequently, education loan and transportation cost are ineluctable features in determining YPs' housing affordability. Other factors are also discussed in this study.

## **LITERATURE REVIEW**

### **Housing Affordability Approaches**

A plethora of methodologies have been used to study housing affordability and they have been documented in voluminous working papers. The price to income ratio (PIR) approach is accepted by practitioners worldwide (Jewkes & Delgadillo, 2010) and considered as a prominent approach as it is easily computed and apprehended (Belsky, Goodman, & Drew, 2005). Accordingly, this approach computes that the standard for housing affordability is assumed to be met when 30% or less of gross household income is spent for housing cost. Another almost identical approach to PIR is housing expenditure to income ratio (HEIR), in which 25–30% benchmark is used. Precisely, the concept assumed one week's pay for one month's rent (Hulchanski, 1995). Initially, the market basket approach (MBA) was revealed in 1975, which is different from others as it is based on adequacy of remaining income for household expenditure after paying housing cost. The household is seen to meet housing affordability if they have adequate money left for household expenditure.

Similarly, the residual approach employs almost duplicate standpoint with the MBA, in which sufficiency for household expenditure cost are signified for affordability (Henman & Jones, 2012). However, the residual approach emphasises more on household sustainability. From this perspective, a household is seen to have housing affordability if they meet the expense of housing cost and



other necessities and this definition also cogitates housing quality (Henman & Jones, 2012).

Overall, one criticism of the PIR approach is that it excludes the non-housing cost and disregards the diversity of the household. In fact, the 30% of affordability benchmark is different from the diversity of the housing market (O'Dell, Smith, & White, 2004). Hence, using the percentage as a rule of thumb in determining housing affordability is debatable. In this respect, the household might have the capability for mortgage or rental payment if 25 to 30% of income is used to determine affordability, but undeniably the household is inclined to drop below the poverty line if their other necessities at the minimum level cannot be met. Tconfusion.hen, with regard to household size, for instance, couples without children are more likely to be able to afford a mortgage and meet other necessities easily as they have a small household size compared to couples who have children. Another drawback of PIR, HEIR, and MBA is that they do not take into account the housing quality.

Consequently, the residual is seen an appropriate approach as it not merely considers the housing affordability, but also the household capacity to meet the standard of living. In the similar vein, the residual is also associated with 'shelter poverty' benchmark (Stone, Burke, & Ralston, 2011), in which the household with irrelevant living standard is considered as unaffordable for housing and observed as being in shelter poverty. Another equally important point is that the residual is also sensitive to the household structure and diverse income level.

Despite that, one great puzzling question is that what is a budget indicator for the household expenditure, as the household diversity might be different from one another. This issue also receives attention among international scholars specifically in Australia and as a result, they summarised nine budget indicators, namely housing cost, energy, food, clothing, household goods and services, health, transportation, leisure, and personal care (Henman & Jones, 2012). In local context, a study on housing affordability with the residual approach had been carried out, but the study neglected the budget indicator and instead asked respondents for the total household expenditure (Sani, 2015). Accordingly, this study has been improved, in which the budget indicator from the Department of Statistics, Malaysia and Bank Negara Malaysia was employed for this study. With regard to this matter, twelve indicators were studied, namely food and non-alcoholic beverage, alcoholic beverage and tobacco, clothing and footwear, utilities, household maintenance, health, transport, communication, recreation services and culture, education, restaurants and hotels, and miscellaneous goods and services.

The residual approach is computed by deducting the housing cost and household expenditure from household income. In this case, mortgage instalment and rental are used to measure affordability for homeowners and tenants.

Meanwhile, those who live in parental homes were asked about their intention of buying a home in the near future, house price target, and location. A simulation is made by supported the mortgage loan calculator to identify the prospective home buyers' affordability to pay mortgage instalment. Based on this, the prospect's mortgage instalment is used to compute their affordability.

### **Predictors Descriptions**

With regard to determining housing affordability, household income is a ubiquitous predictor that cannot be deserted (Osman, Khalid, & Yusop, 2017). Household income in the study is defined as a single income for a single person and dual income if the husband and spouse are working while other breadwinners in the household such as relative members were disregarded. Only permanent income was counted in the study and the household income questions in the survey were presented as open-ended questions.

Another compelling point in this paper was gathering the information on household expenditure adequacy. Therefore, the respondents were required to declare their household expenses based on the indicator given. Similarly, the respondents were required to provide transportation cost based on features such as petrol, toll, car park, train ticket, service charge, vehicle's monthly instalment, insurance, and other expenses that are linked to their transportation. Yet again, an open-ended question was used for this section.

This study aims to determine YPs' housing affordability; hence, education loan is appropriate to be investigated because the target respondents obtained their tertiary education by applying education loans, while some others received scholarships. In this respect, how the education loan possession affect housing affordability was studied extensively. In the survey, education loan was decoded by a nominal scale; YES for those taking education loans and NO for those being under scholarship or supported by parents and not taking loans. An equally important aspect of this study is that it also examines how an individual with different professions differ in their housing affordability. As mentioned before, four professions were involved in the study. Another demographic question of the study was about the status of the presence of children in the household and how it affects YPs' housing affordability.

## RESPONDENTS' BACKGROUND

YPs are respondents in the study and referred as those with at least a Bachelor's degree which aligns with Malaysia Standard Classification of Occupations benchmark (Ministry of Human Resources Malaysia, 2010). The benchmarking of YPs' age is adopted from the late youth cohort definition which ranges between 25 to 35 years old (Hamzah et. al., 2007). In contrast, age between 15 and 40 has been accepted broadly in Malaysian perspective, but this range is open to dispute. In this respect, they are considered to have one or two years of working experience cumulatively when the range 25 to 35 is referred as YPs. Another essential point is that YPs are narrowed from the built environment area to four professions namely engineer, architect, urban planner, and quantity surveyor. Prominently, these professions have been accredited by professional institutions and set out in profession act respectively. Additionally, YPs were restricted to those working or living in Klang Valley. Then, this cohort is considered as falling within the M40 group, with household income approximately MYR 3860 to MYR 8320. However, in the factual data, it was found that there were also YPs who received a salary under MYR 3860.

## METHODOLOGY

A probability sampling method was used to collect data of four professions from professional institutions such as the IEM, MIA, and MIP, and RISM. A sample of 264 respondents was random selected using self-administered and researcher-administered methods. The sample size has been determined as shown in Table 1.

**Table 1:** Population and sample size of young professionals

Profession	Engineer	Architect	Urban Planner	QS	Total
Population	110	75	60	80	325
Sample Size	86	60	51	67	264

*Source: This study*

Data were collected between January 2017 and April 2017 in the Klang Valley. The data involved a mix of categorical and continuous variables. Consequently, the questionnaire was designed with open ended and nominal question form. The binary logistic regression, therefore, was used to analyse the data. The housing affordability levels were measured at two levels, where Level 1 means that the housing is affordable while Level 0 is not affordable. Then, the relationship between the independent and dependent variables is not a linear function in logistic regression, but the logistic regression function is applied by the logit transformation of  $\Theta$ :

$$\Theta = \frac{e (\alpha + \beta_1 x_1 + \beta_2 x_2 + \dots + \beta_i x_i)}{1 + e (\alpha + \beta_1 x_1 + \beta_2 x_2 + \dots + \beta_i x_i)}$$

Where:

$\Theta$  = the probability that a case is in a particular category  $e$  = the base of natural logarithms (approx. 2.72)

$\alpha$  = the constant of the equation

$\beta$  = the coefficient of the independent variables

## RESULTS AND ANALYSIS

The ownership type for the study is divided into three categories which comprises homeownership, rent, and parental home. However, the respondents who are renting and living with family were asked about affordability for buying a house with the reasonable and affordable price at the location of their choice. Housing affordability with residual approach is defined by employing the following rule:

$$\text{Housing Affordability} = \frac{\text{Monthly Household Income} - \text{Housing Cost}}{\text{Monthly Household Expenditure}}$$

Referring to the equation above, the household is considered as having housing affordability if they have remaining income (positive amount) after deduction for housing cost and household expenditure and vice versa.

The outcomes in Table 2 were computed by employing this equation. The value of 1\* in Table 2 is referred as having housing affordability while 0\*\* as not having housing affordability. Table 2 compares the housing affordability among four professions and is divided into three types of ownership. At first glance, it is evident that most of YPs (109 respondents) are renting, followed by homeownership (84), and living at parental home (72). With regard to housing affordability of homeownership and renting, all four professions (about 70 and 95 respondents) had affordability respectively and only 14 respondents for each home ownership and renting were seen as having difficulty. Interestingly, when the respondents from renting market and parental home were asked about buying a home in the near future, it was evident from about 99 respondents that they cannot afford to buy a home and only 79 respondents were shown as having affordability.

**Table 2: Housing affordability among young professionals**

<i>Professions</i>	<i>Ownership Type</i>									
	<b>Home ownership</b>			<b>Rent</b>			<b>Family Residence</b>		<b>Prospect Buying</b>	
	1*	0**	Total	1*	0**	Total	1* 0** Total	1*	0**	Total
Engineer	23	4	27	37	4	41	18	36	22	58
Architect	25	6	31	15	2	17	13	12	17	29
Urban Planner	10	1	11	24	4	28	13	14	26	40
Quantity Surveyor	12	3	15	19	4	23	28	17	34	51
<b>Total</b>	<b>70</b>	<b>14</b>	<b>84</b>	<b>95</b>	<b>14</b>	<b>109</b>	<b>72</b>	<b>79</b>	<b>99</b>	<b>178</b>

1\* Affordable 0\*\* Unaffordable  
*Source: This study*

A logistic regression analysis was conducted to predict housing affordability among 264 young professionals. The result of the logistic regression analysis in Table 3 indicates that the nine independent variables model provided a statistically significant improvement over the constant model, model  $\chi^2 (9, N = 264 \text{ chi square} = 120.327, p < 0.05$  with  $df = 10$ . The Nagelkerke pseudo  $R^2$  indicated that the model accounted for 52.2% of variance. The prediction success was relatively high; for those who could not afford for housing affordability was 64.9%, for those who could afford for housing affordability was 89.3%, and the overall accuracy was 82.2%. Table 3 presents the full results. From the Wald test report, nine predictors which consisted of Engineer, Architect, Quantity Surveyor, Total Household Expenditure, Total Transportation Cost, Vehicle Instalment, Total Household Income, Education Loan I (taking loan), and Education Loan III (full settlement) were significant contributors to housing affordability while Urban Planner, Education Loan II (not taking education loan), and Presence of Children were not significant contributors to the model.

Referring to Table 3, it is noticeable that the significant value for predictors of Urban Planner, Education Loan II, and Presence of Children were more than 0.05 ( $p > 0.05$ ). The influence of Education Loan III (full settlement) was very strong. *Exp (B)* value indicated that when Education Loan III is raised by one unit, the odds ratio is 25 times as large. Then, to make certain whether the predicted probabilities match the observed probabilities or not, the Hosmer and Lemeshow test was conducted. With regard to this matter, a significance value of more than 0.05 indicates that the model is fit. This study also indicated that the Hosmer and Lemeshow test is fit when the significance value was 0.460.

**Table 3:** Determinants of young professionals' housing affordability: Binary logistic regression models

Variable	B	S.E	Wald	df	Sig.	Exp (B)	95% C.I. for EXP(B)	
							Lower	Upper
Engineer			15.818	3	.001			
Architect	-1.057	.530	3.978	1	.046	.348	.123	.982
Urban Planner	.186	.538	.120	1	.729	1.205	.420	3.458
Quantity Surveyor	-1.684	.506	11.068	1	.001	.186	.069	.501
Total Household Expenditure	-.002	.001	9.628	1	.002	.998	.997	.999
Total transportation cost	-.003	.001	18.905	1	.000	.997	.996	.998
Vehicle Instalment	.003	.001	7.378	1	.007	1.003	1.001	1.005
Total household income	.001	.000	29.056	1	.000	1.001	1.001	1.002
Education Loan I (Taking loan)			6.629	2	.036			
Education Loan II (Not Taking loan)	2.409	1.570	2.353	1	.125	11.123	.512	241.532
Education Loan III (Full Settlement)	3.219	1.610	3.996	1	.046	25.005	1.065	587.132
Presence of Children	-.642	.637	1.016	1	.313	.526	.151	1.834
Constant	-1.521	1.834	.688	1	.407	.219		

a. Variable(s) entered on step 1: Occupation, Total Household Expenditure, Total Transportation Cost, Vehicle Instalment, Total Household Income, Education Loan, Presence of Children.

b. Pseudo R<sup>2</sup> 0.522

Source: This study

## DISCUSSION AND CONCLUSION

The most obvious finding from this study is that most YPs able to afford houses whether as homeowners, renting, or prospect homeowners, and are concurrently preserving their living standard without dropping below the poverty line. Nevertheless, the fact of the matter is that the number of respondents in the renting market was outnumbered by homeownership (109 to 84 YPs). The decision to rent was due to work as some YPs, especially civil engineers and architects, were required to be mobile as their jobs were on a contract basis. However, there were also respondents who could not afford to buy houses in the current market; therefore they remained in the renting market. Meanwhile, YPs who had families in Klang Valley were seen as more fortunate as they could live at their families' residence. Another key empirical outcome was that the number of YPs who could not afford to buy a house in the near future was outstripped to those who could afford by 20 respondents (99 to 79). This result indicated that 99 YPs needed to be addressed as they were considered to be adversely impacted on the housing affordability issue.

Investigation of factors that influence housing affordability found that total household expenditure, total transportation cost, vehicle instalment, total household income, taking education loan, taking education loan with full

settlement, professions such as engineer, architect, and quantity surveyor had significant contributions to the model. As anticipated, total household income, household expenditure, transportation cost, and education loan were influential to housing affordability.

In fact, household income was a ubiquitous predictor in many previous researches. In a different research, difficulty in providing a deposit, insufficient affordable house supply, house size preferences and struggle to secure the loan contributed to the housing affordability issue (Bujang et al., 2015). However, this particular study is emphasising merely on assessment of household expenses toward housing affordability.

In this study, vehicle instalment has a substantial effect to housing affordability. Prior to the study, an investigation concerning Malaysian millennials' debt was conducted and it was discovered that hire purchase loan was the most common cause for debt, approximately 56% of young people were burdened by it. It is irrefutable that YPs require transportation for work. For instance, an engineer requires a vehicle to facilitate movement between office and project sites; this circumstance is equivalent to other professions. From this perspective, YPs who just started to join the job market have propensities to establish themselves by applying hire purchase loans. The circumstance is exacerbated if they are more attracted to pursue the high segment cars which are associated with high costs for car instalments and eventually having the potential to eliminate housing affordability. The existence of the graduate car scheme for instance, encourage YPs to buy a car without a down payment and the leniency of the scheme is an ensnarement to the issue. Furthermore, one must bear in mind that they are not merely responsible for the car instalment but simultaneously other costs related to their vehicle such as insurance, tax, service, and maintenance.

Contrary to expectations, this study did not find a significant contribution of the predictor of presence of children to the housing affordability. Initially, the presence of children has been hypothesised to affect housing affordability because household expenditure is sensitive to an increase in the household size, which influences affordability. In spite of that fact, the result indicated that YPs' housing affordability was not improved regardless of the household having children or not. Another two predictors, Urban Planner and Education Loan III (not taking loan), also did not affect affordability. In this respect, YPs who do not take education loan understandably have a more privileged financial condition after graduation; therefore, they are less burden for paying education loan and have less risk to be listed in CCRIS that eliminates their probability for buying a house. Meanwhile, the profession as an urban planner has less effect to affordability issue. The reason behind this case is because more urban planners are renting instead of owning a home, as sharing a rental house with friends is most affordable.

## REFERENCES

- Belsky, E. S., Goodman, J., & Drew, R. (2005). *Measuring the nation's rental housing affordability problems*. Cambridge, MA: Joint Center for Housing Studies, Graduate School of Design John F. Kennedy School of Government, Harvard University.
- Bujang, A. A., Anthony Jiram, W. R., Abu Zarin, H., & Md. Anuar, F. H. (2015). Measuring the gen Y housing affordability problem. *International Journal of Trade, Economics and Finance*, 6(1), 22-26.
- Hamzah, A., Krauss, S. E., Noah, S. M., Suandi, T., Juhari, R., Manap, J.,...& Kassan, H. (2007). *Muslim religiosity and personality assessment: Prototype for nation building*. Serdang, Selangor: Institute for Social Sciences Studies (IPSAS)-University Putra Malaysia.
- Henman, P., & Jones, A. (2012). *Exploring the use of residual measures of housing affordability in Australia: Methodologies and concepts*. AHURI Final Report No. 180, Australian Housing and Urban Research Institute Limited, Melbourne, <https://www.ahuri.edu.au/research/final-reports/180>.
- Hulchanski, J. D. (1995). The concept of housing affordability: Six contemporary uses of the housing expenditure-to-income ratio. *Housing Studies*, 10(4), 471-491.
- Jewkes, M. D., & Delgadillo, L. M. (2010). Weaknesses of housing affordability indices used by practitioners. *Journal of Financial Counseling and Planning*, 21(1). Retrieved from [https://papers.ssrn.com/sol3/papers.cfm?abstract\\_id=2222052](https://papers.ssrn.com/sol3/papers.cfm?abstract_id=2222052)
- Khazanah Research Institute (2015). *Making housing affordable*. Kuala Lumpur: Author.
- Ministry of Human Resources Malaysia (2010). *Malaysia standard classification of occupations*.
- O'Dell, W., Smith, M. T., & White, D. (2004). Weaknesses in current measures of housing needs. *Housing and Society*, 31(1), 29-40.
- Osman, M. M., Khalid, N., & Yusof, S. W. M. (2017). Housing affordability in the state of Selangor, Malaysia. *Advanced Science Letters*, 23(7), 6118-6122.
- Sani, N. M. (2015). Relationship between housing affordability and house ownership in Penang. *Jurnal Teknologi*, 75(9), 65-70.
- Stone, M. E., Burke, T., & Ralston, L. (2011). *The residual income approach to housing affordability: The theory and practice*. AHURI Positioning Paper No. 139, Australian Housing and Urban Research Institute Limited, Melbourne, <https://www.ahuri.edu.au/research/position-papers/139>.





**PLANNING MALAYSIA:**  
*Journal of the Malaysian Institute of Planners*  
**VOLUME 16 ISSUE 2** (2018), Page 99 - 108

## **HOUSING AND TRANSPORT EXPENDITURE: AN ASSESSMENT OF LOCATION HOUSING AFFORDABILITY**

**M. Azren Hassan<sup>1</sup>, Hazlina Hamdan<sup>2</sup>, Jamalunlaili Abdullah<sup>3</sup>, & Yusfida Ayu Abdullah<sup>4</sup>**

*<sup>1,2,3,4</sup>Faculty of Architecture, Planning and Surveying*  
UNIVERSITI TEKNOLOGI MARA MALAYSIA

### **Abstract**

In every country, the ability to own a house is vital for the housing market. During the past five years, housing prices in the urban area in Malaysia are becoming severely unaffordable. Housing affordability ensures that housing provided is affordable for every income groups, especially the low and middle income group. The measurement of housing affordability uses household income and housing cost but disregards transportation expenditure which is a substantial amount of household expenditure. Location of housing influences transportation expenditure. The research determines the Location Housing Affordability for the low and middle income group in an urban area. This study quantitatively examines Putra Height as one of the mature residential neighbourhoods in Selangor as well as due to the availability of public transit in the area. Housing affordability and transportation affordability create an integrated Location Housing Affordability Index. Data analysis utilizes the measurement of Location Housing Affordability Index. The findings showed that Location Housing Affordability Index recognizes location as influential factor to housing affordability of 179 respondents from low and middle income group. The findings also suggested that the houses in the urban area were seriously unaffordable for the low and middle income groups. The contribution of the research is the emphasis on location as a part of housing affordability measurement.

**Keywords:** location housing affordability, low and middle income, transportation expenditure

<sup>1</sup>Email: mohdazrenhassan@gmail.com

## **INTRODUCTION**

The condition of socioeconomic stability and development in a country concern the housing market. Therefore, the ability to own a house is very crucial. The fundamental economic and social needs for everyone is the right to appropriate housing yet affordable and appropriate needs (Drudy, 2007; Osman, Yusof, Shuid, & Abdullah, 2017). Comfortable housing will contribute to health and well-being. Therefore, owning a home is the dream of every individual. Finding affordable, secure and adequate housing in term of location is one of the biggest problems of Malaysian households today.

Housing within an urban area is more expensive as compared to housing in a rural area, added further there were few differences in the locations of greatest housing affordability between housing tenures, and this proven with the spatial mismatch of location and affordable houses (Dodson, 2005; Khazanah Research Institute, 2015; Osman et al., 2017) Housing prices are also heavily dependent on location since there is a relation to the role of location in the housing market (Guan, 2012; Lipman, 2006) Therefore, location does have an influence not just on housing expenditure but also towards on-going transportation expenditure, in particular, the distance between residential neighbourhoods and employment centres (Lipman, 2006; Mattingly & Morrissey, 2014).

There are many types of research on housing affordability conducted in Malaysia which focus on socio demographic such as low-income group and also on youth. Nevertheless, none of those research has made a comparison between two income groups (Zyed, 2014; Bujang, Zarin, & Jumadi, 2010; Mahmud & Hussein, 200; Sani, 2013; Sani, 2007). To make a comparison between two income groups are very crucial to identifying housing affordability of an urban area. This research focuses on location housing affordability within an urban area in Selangor. With this comparison of the two income level groups, the finding from the research will be more fitting and easily relates to location housing affordability. To achieve that, this research will evaluate housing and transportation expenditures based on questionnaire survey.

The targeted population is the urban dweller in a mature residential area of Selangor, consisting of the middle and low income groups. The research aims to assess housing and transportation expenditure using Location Housing Affordability in an urban area of Selangor (Jain & Brecher, 2014). Three research questions were posed as the objectives of this research, (1) How does affordability differ when transportation expenditure is part of affordability index? (2) How do household housing and transportation expenditure vary for the low and middle income group in an urban area? (3) Is urban housing area in Selangor be unaffordable?

The findings from the research would, therefore, provide various results of housing affordability and differences between the middle and low income

groups in an urban area based on Location Housing Affordability Index. At the same time, the result would show that location does matter for affordable housing.

### **HOUSING EXPENDITURE AND LOCATION**

In terms of monetary, housing expenditure is a large amount of the household budget. The low-income group, however, have extra strain on a budget for others essential expenditures such as food, transportation, healthcare and education. Households were paying more than half of their income on housing expenditure usually spend substantially less than other families on essential expenses such as food, clothing, and health care (Streimikiene, 2015). As the size of the family increases, these difficulties tend to worsen. If the provision and conditions of low-cost and middle-cost housing are good on the one hand, the high housing expenditure on the other side constitutes a major concern for households.

Hence the housing stress will formulate and hinder the relations between the household members and damper the development of the children in term of the children education and health (Zainal, Kaur, Ahmad, & Khalili, 2012). It agreed in the past that location of the low and middle-income group has fewer amenities compare to other income groups, due to their ability to spend more on great amenities (Bieri, 2013). Therefore housing affordability can impend the households' physical well-being and economic security. The provision of adequate and affordable housing is essential in a growing economic nation and also part of the quality of life.

The important aspect of provision is how affordable housing is to the people? Housing prices were also heavily dependent on location. For example in the State of Selangor, the state as moderately unaffordable because the research had included rural areas such as Kuala Selangor, Hulu Selangor, Kuala Langat and Sabak Bernam, where the housing price is lower as compared to urban areas of Selangor, Petaling Jaya, Subang Jaya and Shah Alam (KRI, 2015, Osman et al., 2017). Evidently, there is an issue of housing affordability in the urban area, and spatial geographical location does play as part of housing affordability. Finding affordable, secure and adequate housing in term of location is one of the biggest problems of low and middle-income households' today especially in urban area.

### **HOUSING AFFORDABILITY CONCEPT & MEASUREMENT**

The concept of housing affordability was first used in the United Kingdom and the United States since 1960 and 1980 with different policy objectives (Mostafa, Wong, & Hui, 2006). In the United Kingdom, the concept of housing affordability uses the current housing system based on a market-oriented system to help those in need. Households have to balance their housing costs and non-housing expenditures, given a limited income (Mallach, 2009; Quiqley & Raphael, 2004; Stone, 2006; Chowdhury, 2013; Whitehead, 1991; Swartz & Miller, 2002).

However, housing affordability lacks a precise definition as affordability is not a natural characteristic of housing but rather a relationship between income and relative prices (Stone, 2006). From various perspectives and contexts, the term of housing affordability is the ability of an average household's willingness to own and sustain an average home (housing-related costs) without being financially distressed after the purchase as well as retaining a socioeconomic stability.

The various definitions and concepts of housing affordability led to different approaches towards measuring housing affordability such as house price to income ratio, residual income after housing costs, and purchase and repayment affordability (Stone, 2006; Tawil, Shuhaida, Hamzah, Che-Ani, & Tahir, 2015; Gann, & Hill, 2009). There is lack of agreement on the correct or precise measurement of housing affordability. In most countries including Malaysia, commonly used measurement of housing affordability is housing expenditure-to-income ratio. The distinction between of affordable and unaffordable relies on the allocated 30% of the income that is if the house costs more than 30% of income considered as unaffordable and vice versa (Hulchanski, 1995).

The indicator measurement for housing expenditure-to income ratio has several limitations. One of the critics for this indicator is it's incompetence to distinguish housing quality. High housing prices should offer better features. Whereas low housing price offer unfavourable features such as an unsafe building structure and unfavorable location (Stone, 2006; Bogdan & Can, 1997). Nevertheless, a higher housing expenditure along with high interest would burden household income. However, the housing expenditure-to income ratio indicator can be used to identify the low and middle income groups' financial problem in relation to housing affordability.

In recent years, there is a new indicator on housing affordability which includes transportation expenditure (Litman, 2014; Sabri, Ludin, Johar, 2013; Yusoff, Adnan, & Rasam, 2014). Housing and transportation are the two largest expenses for most households. Together, they account for more than half of household spending (Jewkes & Delgadillo, 2010). The transportation expenditure measures the geographical and transportation factor of housing affordability. The three most important variables to determine transportation expenditure are vehicle ownership, vehicle usage and public transit. The increase of vehicle ownership is the result of shortage in public transportation to access employment and services especially in urban area. Therefore a significant amount of income has to be spent for transportation expenditure.

Distance between housing location and employment location can harm financial stability of housing owners. While acquiring houses in suburban area at a lower price is a good strategy for financial savings, the increasing cost of transportation inevitably reduce the savings. The measure of housing and transportation expenditure is chosen for this research since it considered location as an influencing factor of housing affordability. In order to achieve a financially

affordable life, both housing and transportation expenditure must be under 45 % of total income. The 45 % mark will be the affordability measurement for the Location Housing Affordability (Litman, 2014).

## **RESEARCH METHODOLOGY**

### **Study area**

Selangor is selected as a case study due to its dense population in Malaysia. Together with the accessibility of highways and public transports, good infrastructure and high standard of living, Selangor appears to be the most developed state in Malaysia.

One of the prominent residential areas in Selangor is Putra Height. Putra Height has different ranges of houses that suit with low and middle income groups. Therefore, the people living in the residential area are within the targeted income group. Putra Heights is chosen as a case study due to the availability and accessibility to public transportation. The recent opening of the extended LRT lines to Putra Heights indicates that the residential area is very convenient for public transit users. The connection of highways and main roads surrounding Putra Heights has made the location one of the best residential areas to live in.

### **Data Collection**

This research uses quantitative method based on the housing affordability survey. Questionnaire survey was conducted using questionnaire form due to the sensitivity of respondents' financial information. Randomly, 179 respondents were selected and interviewed within the study area. The questions include respondents' income range which are (i) the low income group (81 respondents) and (ii) the middle income group (98 respondents). The structure of the questions is divided into three main variables involving location housing affordability, housing expenditure and transportation expenditure. Finally, the measurement of location housing affordability was made to identify housing affordability among the low income and middle income groups in the urban area.

### **Household Income, Housing & Transportation Expenditure**

In this research, household income is divided into the low income group and middle income group. The income range for the low income group or the B40 is less than RM2, 537, and the income range for the middle income group or the M40 range from RM3, 860 to RM8, 319.26. The median value has been used to measure the household income rather than mean value because the median value eludes the skewing of data by outlier (see Table 1).

For housing expenditure, the monthly mortgage payment and monthly amount of utility bills such as telephone, electricity, water, internet and others

represent the variables. Transportation expenditure is divided into three variables which are vehicle ownership, vehicle usage and public transit.

Vehicle ownership is determined by the number of the vehicle, monthly payment of the vehicles, and the annual amount of insurance and tax. Vehicle usage is based on the average annual kilometre travel in Selangor which is 28,576 km together with the distance of the respondents travelling to work (Shabadin, Megat Johari, & Mohamed Jamil, 2014). Hence allowing calculation of the amount of fuel used. Apart from that, vehicle usage is also based on the monthly amount of toll and parking fees together with repair cost and maintenance. Public transit will be the total amount of monthly expenses on public transport as the main transportation. Adding up all the variables will then give the mean transportation expenditure.

**Table 1:** Elements and variables of location housing affordability

Measure	Variables
Median household income	Total household income
Mean housing expenditure	Monthly mortgage payment + total utilities payment
Mean transportation expenditure	Vehicle ownership + vehicle usage + public transit

The method to compute a simplified location housing affordability is as per equation below:

$$LHA : \frac{mHi - (\mu He + \mu Tc)}{Hi}$$

*LHA* is Location Housing Affordability. Where *mHi* is the median of household income,  $\mu He$  is the mean housing expenditure for the household, and  $\mu Tc$  is the transportation expenditure. The equation to compute for  $\mu He$  and  $\mu Tc$  is as per below:

$$\mu He : Mp + Ub$$

$$\mu Tc : Vo + Vu + Pt$$

*Mp* is the monthly mortgage payment, *Ub* is the total monthly amount of utility bills, *Vo* is the vehicle ownership, *Vu* is the vehicle usage, and *Pt* is the public transit. Affordability categories is based on the result of the location housing affordability index as shown in table 2.

**Table 2:** Affordability categories

Rating	LHA Result
Affordable	> 0.55
Moderate unaffordable	0.54 – 0.40

Seriously unaffordable	0.39 – 0.25
Severely unaffordable	< 0.24

*Source: Litman, (2014)*

### DATA ANALYSIS AND RESULT

The data analysis was divided into three parts which are (i) the low income group (B40), (ii) the middle income group (M40) and (iii) both income groups representing the residents of Putra Height. The median household income for the low income group was RM2,502, and for the middle income group was RM6,261.

Transportation expenditure does have an influence towards housing affordability (Table 3). Based on the location housing affordability index, the result showed that the low transportation expenditure for overall respondents were RM2,299 (48% of overall median household income). However none of the respondents used the public transit as their main transportation even though Putra Height had the connectivity of two LRT lines. The LRT station built after Putra Height was known as a prominent residential area not as Transit Oriented Development (TOD). Most of the residents used their own vehicles resulting to high transportation expenditure.

In terms of value, middle income has higher mean transportation expenditure, and the mean household expenditure than the low-income group is because the middle-income group have the ability to spend more. For example on the utility bills, the middle-income group have to installed internet connection and satellite television. Most of the middle-income group own more than one vehicle due to working households that require vehicles to travel to work.

There was a slight difference between the low and the middle income groups in terms of the housing and transportation expenditure. The result of location housing affordability for the low income group was 0.30, and the middle income group was 0.34. Despite the difference of 0.04, the area is still unaffordable. Both low income group and middle income group struggled on housing affordability along with the rapidly increasing cost of living in the urban area.

The overall location housing affordability result was 0.25. The result revealed and agreed with a recent research mentioning that urban area in Selangor is seriously unaffordable. The importance of transportation should be seriously considered by the policy makers together with locality and affordable housing.

**Table 3:** Location affordability result by income group in Putra Height

Measure	Variables	B40	M40	Overall
Median household income	Respondent Salary (RM)	1,331	3,710	2,659
	Spouse's Salary (RM)	1,171	2,551	2,150
	Total (RM)	2,502	6,261	4,809
	Monthly Payment (RM)	430	1225	1,095
	Utilities Bills (RM)	86	284	197

Mean household expenditure	Total (RM)	516	1509	1,292
Mean transportation expenditure	Vehicles Ownership (RM)	393	1580	1,368
	Vehicles Usage (RM)	833	1,035	931
	Public Transit (RM)	0	0	0
	Total (RM)	1,226	2,615	2,299
LHA Result		0.30	0.34	0.25

## CONCLUSION

There appeared to be flaws for the current and conceptual measurement of housing affordability due to the exclusion of transportation expenditure. Location housing affordability in this research has shown that location has an influence towards housing affordability. The findings show that the urban areas are becoming seriously unaffordable. This research agrees that housing affordability in urban area especially in Selangor is seriously unaffordable. A simplified computation of Location Housing Affordability index used for the measurement of the locality is proven to be more precise as it takes into account the location of the housing areas. Location Housing Affordability index shift the vague definition of affordability to integrate the transportation expenditures. The Location Housing Affordability Index should be considered as an indicator for quality of life assessment as the measurement is inclusive of transportation expenditure. Housing affordability can impend the households' physical well-being and economic security. Policy makers should be mindful of the importance of transportation, locality and affordable housing towards better quality of life of the citizens.

Providing affordable housing especially for low and middle income groups especially in the urban areas improve quality of life. Moreover, the term 'location' should be a part of the definition of affordable housing as it influences household expenditure. Further studies should be carried out on location housing affordability with other socio-demographic groups such as medium-income group, youth civil servant, and elderly. The findings would provide better understanding on the issues of housing affordability in Malaysia.

## REFERENCES

- Bujang, A. A., Zarin, H. A., & Jumadi, N. (2010). The relationship between demographic factors & housing affordability. *Malaysian Journal of Real Estate*, 5(1), 49-58.
- Bieri, D. S. (2013). Housing Affordability. In A. Michalos (Ed.), *Encyclopedia of quality of life research*. New York/Heidelberg: Springer Verlag.
- Bogdan, A. S. & Can, A. (1997). Indicators of local housing affordability: Comparative & spatial approaches. *Real Estate Economics*, 25(1), 43-80.



- Chowdhury, M. Z. S. (2013). The housing affordability problems of the middle & low income groups in Dhaka: A policy environment analysis (Thesis). University of Hong Kong, Hong Kong.
- Dodson, J. (2005). *Is there a spatial mismatch between housing affordability & employment opportunity in Melbourne?* AHURI Final Report No. 80, Australian Housing and Urban Research Institute Limited, Melbourne. Retrieved from <https://www.ahuri.edu.au/research/final-reports/80>.
- Drudy, P. J. (2007). Housing in Ireland: Philosophy, affordability & access. *Journal of the Statistical & Social Inquiry Society of Ireland*, XXXVI, 84-125.
- Gann, Q. & Hill, R. J. (2009). Measuring housing affordability: Looking beyond the median. *Journal of Housing Economics*, 18(2), 115-125.
- Guan, M. (2012). How to affect housing values: Location, affordability, & amenity. *African Journal of Business Management*, 6(16), 5593-5598.
- Hulchanski, J. D. (1995). The concept of housing affordability: six contemporary uses of the housing expenditure to income ratio. *Housing Studies*, 10(4), 471-491.
- Jain, R. & Brecher, C. (2014). *Housing affordability versus location affordability: The rent's too damn high! But the Metrocard is a pretty good deal*. Retrieved from <https://trid.trb.org/view/1321381>
- Jewkes, M. D., & Delgado, L. M. (2010). Weaknesses of housing affordability indices used by practitioners. *Journal of Financial Counseling and Planning*, 21(1). Retrieved from [https://papers.ssrn.com/sol3/papers.cfm?abstract\\_id=2222052](https://papers.ssrn.com/sol3/papers.cfm?abstract_id=2222052)
- Khazanah Research Institute [KRI] (2015). *Making housing affordable*. Kuala Lumpur: Author.
- Lipman, B. J. (2006). A heavy load: The combined housing & transportation burdens of working families. Retrieved from <http://www.reconnectingamerica.org/resource-center/books-and-reports/2006/a-heavy-load-the-combined-housing-and-transportation-burdens-of-working-families/>
- Litman, T. (2014). *Transportation affordability: Evaluation and improvement strategies*. Victoria Transport Policy Institute.
- Mahmud, R., & Hussein, K. (2001). *Kajian ke atas kemampuan membeli rumah bagi golongan sederhana di kawasan Johor Bahru* (Unpublished project report). Universiti Teknologi Malaysia, Malaysia.
- Mallach, A. F. (2009). The case for affordable housing. *Planning*, 75(3), 31-36.
- Mattingly, K., & Morrissey, J. (2014). Housing & transport expenditure: Socio-spatial indicators of affordability in Auckland. *Cities*, 38, 69-83.
- Mostafa, A., Wong, F. K. W., & Hui, C. M. E. (2006). Relationship between housing affordability & economic development in mainland China - Case of Shanghai. *Journal of Urban Planning and Development*, 132(1), 62-70.

- Osman, M. M., Yusof, S. W. M., Shuid, S., & Abdullah, M. F. (2017d). Housing affordability index for districts in Perak. *Advanced Science Letters*, 23(7), 6049-6052.
- Quiqley, J. M. & Raphael, S. (2004). Is Housing Unaffordable? Why Isn't It More Affordable? *Journal of Economic Perspectives* 18, 191-214.
- Sani, N. M. (2013). Residual Income Measure of housing Affordability. *International Journal of Advances in Engineering & Technology*, 5(2), 1-8.
- Sani, N. M. (2007). *Kemampuan pemilikan rumah kos rendah di Kuala Lumpur* (Doctoral dissertation). Universiti Sains Malaysia, Malaysia.
- Stone, M. E. (2006). What is housing affordability? The case for the residual income approach. *Housing Policy Debate*, 17, 151-184.
- Swartz, R. & Miller, B. (2002). Welfare reform & housing. In I. V. Sawhill, R. K. Weaver, R. Haskins, & A. Kane (Eds.), *Welfare reform & beyond: The future of the safety net* (pp. 197-204). Washington D.C: Brookings Institution Press.
- Shabadin, A., Megat Johari, N., & Mohamed Jamil, H. (2014). Car annual vehicle kilometer travelled estimated from car manufacturer data – an improved method. *Pertanika*, 25(1), 171-180.
- Streimikiene, D. (2015). Quality of life and housing. *International Journal of Information and Education Technology*, 5(2), 140-145.
- Sabri, S., Ludin, A. N. M., & Johar, F. (2013). Assesment of neighbourhood affordability based on housing & transportation costs in Kuala Lumpur, Malaysia. *Planning Malaysia*, 2, 75-100.
- Tawil, N. M., Shuhaida, M. S., Hamzah, N., Che-Ani, A. I., & Tahir, M. M. (2015). Housing affordability in two university towns in Selangor, Malaysia. *Recent Research in Chemistry, Biology, Environment & Culture*.
- Whitehead, C. M. E. (1991). From need to affordability: An analysis of UK housing objectives. *Urban Studies*, 28, 871-887.
- Yusoff, Z. M., Adnan, N. A., & Rasam, R. A. (2014, August). [H+T] Affordability Index for Low-Cost Housing Location-Distribution Procedure. In *Arte-Polis 5 Intl Conference – Reflections on Creativity: Public Engagement and the Making of Place*. August 8-9, 2014, Bandung, Indonesia.
- Zainal, N. R., Kaur, G., Ahmad, N. A., & Khalili, J. M. (2012). Housing Conditions and Quality of Life of the Urban Poor in Malaysia. *Procedia - Social and Behavioral Sciences*, 50, 827-838.
- Zyed, Z. A. S. B. (2014). *Assessment of Housing affordability problems among younger working households in Greater Kuala Lumpur* (Doctoral dissertation). Universiti Malaya, Malaysia.



## **FACTORS DETERMINING THE DEMAND FOR AFFORDABLE HOUSING**

**Xin Ying Lim<sup>1</sup>, Abdullateef Olanrewaju<sup>2</sup>, Seong Yeow Tan<sup>3</sup>, & Jia En Lee<sup>4</sup>**

*<sup>1,2,3,4</sup>Faculty of Engineering and Green Technology*  
UNIVERSITI TUNKU ABDUL RAHMAN MALAYSIA

### **Abstract**

Affordable housing has been defined as housing which is adequate in quality and location. In addition to this, it is deemed to be housing that is not so costly that it prevents its occupants from meeting their basic living needs. This study aims to develop a framework to facilitate affordable housing delivery. The data collection used was a survey questionnaire. The survey was administered to occupants within five high-rise buildings in Penang. The study also utilized a Kaiser-Meyer-Olkin measure of 0.518, and Bartlett's test of sphericity of ( $\chi^2 (210) = 10953.982, p < 0.001$ ). The two statistical test discovered that the major determinants affecting demand for affordable housing were crime rates, housing prices and down payments. The results also demonstrated that six factors were successfully constructed using a factor analysis and assigned as factors that determined the demand for affordable housing. The research will be useful to policy makers, urban planners, developers, and contractors.

**Keywords:** factors, demand, affordable housing, Malaysia

## **INTRODUCTION**

The concept of affordable housing is used to address low and medium income housing around the world. If a buyer allocates 30% of his or her gross monthly household income towards buying a house, it can be said that the housing is affordable. The US HUD (2003) noted that families who paid more than 30% of their income on housing were considered to be cost-burdened and may have difficulty affording basic necessities such as food, clothing, transportation, and medical care. In Malaysia, many households cannot afford their houses because housing prices have outstripped inflation. Housing prices in Malaysia are increasing by about 6% annually (Osman et al., 2017; “Undersupply of affordable houses”, 2017). Therefore, this research aims to investigate affordable housing in Malaysia in an effort to develop a framework to facilitate affordable housing delivery.

The population in Malaysia is increasing significantly. It has been found that in the year 2010, the population was only 28.59 million, while in the year 2017, the population increased to 32.14 million (DOS, 2015).

## **LITERATURE REVIEW**

Malaysia aims to be a fully developed country by the year 2020. The estimated population in the year 2020 will be 32.4 million, it will comprise of 16.6 million males and 15.8 million females (DOS, 2015). The process of becoming a fully developed country has resulted in the demand for housing in Malaysia growing significantly; this has created a housing shortage. Indeed, it has been identified that there were 4,945,140 residential units in the year 2016 (NAPIC, 2017a). An interpretation of the above statistics indicates a ratio of 6 people to one house. This ratio is considered high for a typical house in Malaysia with 2 to 3 bedrooms. Housing prices have increased by a record margin. For instance, between years 2009 to 2016, the house prices have increased by 46.17% all over Malaysia (NAPIC, 2017b). The average house price in Malaysia costs much more than 3 times an individual's annual median income. In median income terms, Malaysia houses are considered to be more expensive than houses in the United Kingdom, United States and Japan (Khazanah Research Institute, 2014).

The median monthly household income has increased from RM 3,626 in 2012 to RM 4,585 in 2014, this is an annual growth rate of 11.7% (DOS, 2015). Data on median monthly household income for 2016 has not been released yet, nevertheless, if a growth rate of 11.7% is applied, it is estimated that the median monthly income in 2016 would be RM 5,720. In median income terms, affordable house in Malaysia is housing that costs around 3 times an annual median income, which is  $[3 \times 12 \times \text{RM } 5,720 = \text{RM } 205,920]$  per house. This means that about 65% of Malaysian households cannot afford to own a house because their salary is below the estimated median income level of RM 5,720 in the year 2016.

Malaysia is undoubtedly experiencing a shortage in the supply of affordable houses particularly in major urban areas (REHDA, 2016). The undersupply of affordable homes in the local property market is expected to deteriorate due to demographic factors and current income trends (“Undersupply of affordable houses”, 2017). Since 2012, the increase in house prices in Malaysia has outstripped the rise in income levels (Cheah & Stefanie, 2017)

### **PROBLEM DESCRIPTION**

Houses within Malaysia are severely unaffordable (DOS, 2015). Consequently, the government has proposed schemes, programs, and incentives for developers, contractors, and homebuyers. Notwithstanding this, the prices of the houses is continuing to increase but the satisfaction levels of the homebuyers has not increased comparatively. Homebuyers seek adequate housing that they afford to purchase (NAPIC, 2017a). Homebuyers also take into account factors such good location of the housing with amenities, a secure tenure, access to housing finance and a degree of mobility and choice, when they look for a house (NAPIC, 2017a). Investigating the factors that predict homebuyer demand will facilitate decision-making in the delivery of affordable housing. Previous researches conducted has investigated homebuyers’ requirements, nevertheless, they have not focused on affordable housing and have not analysed the interaction between the requirements.

### **AIM AND OBJECTIVES**

The aim of the research is to develop a framework to facilitate affordable housing delivery. To achieve the aim, the following objectives have been set:

- a. Prioritize the factors that affect demand for affordable housing; and
- b. Categorize the factors determining demand for affordable housing.

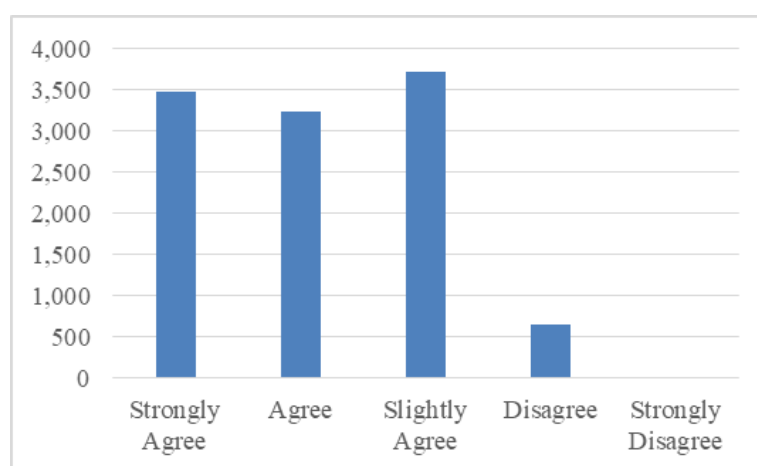
### **RESEARCH METHODOLOGY**

Research can be conducted through a variety of methods, but what determine the ‘best’ method are the purposes of the research in terms of aims, objectives, questions or hypothesis. The study utilised a survey questionnaire which collected primary data. The different variables included in the survey were adopted or adapted from literature (Li, Arditi, & Wang, 2013; Kirkham, 2007; Royal Bank of Canada and the Pembina Institute, 2013), and the authors’ experiences. The survey was administered to occupants within six high-rise buildings in Penang. The levels of importance within the survey questionnaire were measured on a Likert scale of 1 to 5. In the scale, 1 represented extremely important, 5 denoted very low important, 3 denoted important and 2 and 4 fell in between. The housing estate was located in Penang. Each of the housing units consisted of 3 bedrooms and 2 bathrooms with a total built up area between 500 to 999 square feet. A total of 529 home owners were surveyed.

### ANALYSIS AND FINDINGS

It was found that 94.01% of the respondents agreed that 21 factors within the survey determine the demand for affordable housing in Malaysia. This is shown in Figure 1.

To further confirm the strength of the data, Bartlett’s test was conducted. The results signified a lack of multicollinearity among the factors and that the respondents were drawn from those with similar experiences ( $\chi^2 (210) = 10953.982, p < 0.001$ ).



**Figure 1:** Factors determining the demand for affordable housing in Malaysia (Frequency)

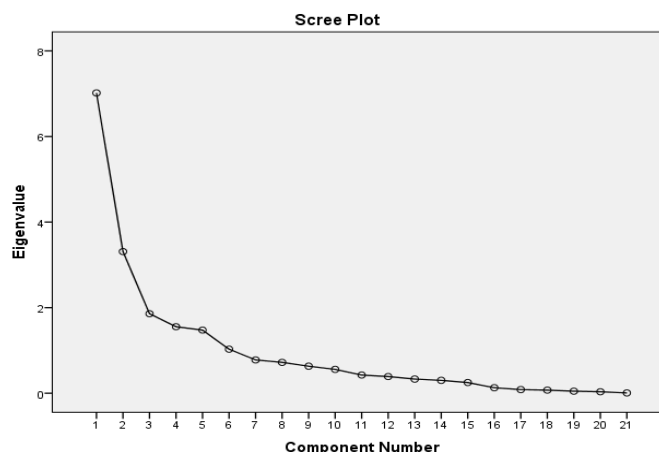
The results shown in Table 1, also indicate that the reliability and validity of the data was very good.

**Table 1:** Reliability and validity of factors determining the demand for affordable housing in Malaysia

Factors	Reliability	Validity	Mean	Std. Deviation
Crime Rate	0.866	0.881	1.442	0.789
House Price	0.860	0.869	1.692	0.611
Down Payment	0.859	0.653	1.839	0.878
Accessibility to Working Place	0.868	0.472	1.849	0.759
Quality of House	0.866	0.768	1.906	0.885
Leasehold / Freehold House	0.858	0.720	1.957	0.883
Interest Rate on Loan	0.866	0.811	2.066	0.924

Access to Children School & Child Day Care Centre	0.869	0.768	2.081	0.768
Household Income	0.866	0.830	2.087	1.002
Ability to Accommodate those with Mobility Restriction	0.851	0.774	2.098	0.867
Available of Own Transports	0.849	0.792	2.153	0.918
Neighborhood	0.852	0.818	2.195	0.966
House Built-up Area	0.857	0.892	2.234	0.867
Availability of Mortgages	0.870	0.765	2.274	0.841
Family Size	0.870	0.414	2.301	0.988
Operation & Maintenance Costs	0.848	0.687	2.333	1.046
Adaptability	0.848	0.911	2.382	0.86
Type of House	0.860	0.919	2.437	0.903
Availability of Credit/Loan Facility	0.856	0.788	2.458	1.013
Available of Public Transport	0.851	0.892	2.52	1.035
Market/ Shopping Mall	0.855	0.818	2.681	0.747

One sample t-test was computed to determine the hypothesis that each of the factors would determine demand for affordable housing in Malaysia. For this reason, the null hypothesis was that the factors would not determine the demand for affordable housing in Malaysia ( $H_0: U=U_0$ ) and the research hypothesis was that the factors would determine demand for affordable housing in Malaysia ( $H_r: U>U_0$ ).  $U_0$  was the population mean or comparison standard mean and the critical level off point was set at 1.5. All the factors were statistically significant. Therefore, all the factors were adequate and suitable to be included in the survey to achieve the aim of the research.



**Figure 2:** Factors determining the demand for affordable housing in Malaysia (Screen Plot)

A factor analysis was used to construct the framework of the survey completed by homeowners. The Bartlett's test of sphericity and Kaiser-Meyer-Olkin measure of sampling adequacy were both tests used to determine the factorability of the matrix as a whole. The resultant value of the Bartlett's test of sphericity was significant ( $p < 0.001$ ,  $p = 0.000$ ).

Table 2 shows that there were 6 components extracted from the analysis. The eigenvalues of these 6 components was greater than 1 which was accepted in the analysis. The total percentage of variance explained by Component 1 to Component 6 was 77.349% which is considered acceptable.

The first component was named transportation cost because it comprises seven factors that determine the demand for affordable housing in Malaysia. More specifically, it explained 21.06% of the variance within the model. The factor loadings for the seven factors ranged between 0.666 to 0.866. A second-order factor analysis combined these seven factors into a single component named transportation cost. The Kaiser-Meyer-Olkin measure of sampling adequacy confirmed a good relationship between the factors ( $MSA = 0.709$ ,  $\chi^2(21) = 3036.128$ ,  $p < 0.001$ ). The seven factors collectively explained 64.53% of the variance within the model. The validity ranged between 0.443 to 0.750. The factors 'down payment' was the least validity (0.483). The collective Cronbach's Alpha reliability for the four factors was 0.906. All these factors relate to transportation cost that home buyers take into account when they look to purchase affordable housing. Savings from transportation cost by home owners can be used towards house purchase.

The second component was named repayment ability because it comprises five factors that determine the demand for affordable housing in



Malaysia. More specifically, it explained 15.68% of the variance within the model. The factor loadings for the five factors range between 0.640 to 0.911. A second-order factor analysis combined these five factors into a single component named repayment ability. The Kaiser-Meyer-Olkin measure of sampling adequacy confirmed a good relationship between the factors ( $MSA = 0.689$ ,  $\chi^2(10) = 1805.548$ ,  $p < 0.001$ ). The five factors collectively explained 65.68% of the variance within the model. The validity ranged between from 0.410 to 0.829, 'family size' was the least validity (0.410). The collective Cronbach's Alpha reliability for the three factors was 0.863. The implication of these results indicates that homebuyers focus on ensuring that their household income will be able to cater the daily needs of their family and to pay their housing loan. Better accessibility to working place would also reduce the cost of transportation.

The third component was named limitation on consumable because it comprises three factors that determined the demand for affordable housing in Malaysia. More specifically, it explained 12.77% of the variance within the model. The factor loading for the three factors ranged between 0.833 to 0.922. A second-order factor analysis combined these three factors into a single component named limitation on consumable. The Kaiser-Meyer-Olkin measure of sampling adequacy confirmed a good relationship ( $MSA = 0.668$ ,  $\chi^2(3) = 696.735$ ,  $p < 0.001$ ). The three factors collectively explained 75.68% of the variance within the model. The validity ranged between 0.695 to 0.850, 'house built-up area' was the least validity (0.695). The collective Cronbach's Alpha reliability for the three factors was 0.831. This means that homebuyers take into account these limitations on consumable when purchasing affordable housing.

The fourth component was named satisfaction because it comprises two factors that determined the demand for affordable housing in Malaysia. More specifically, it explained 10.47% of the variance within the model. The factor loading for the two factors was both 0.935. A second-order factor analysis combined these two factors into a single component named satisfaction. The Kaiser-Meyer-Olkin measure of sampling adequacy indicated a good relationship between the factors ( $MSA = 0.500$ ,  $\chi^2(1) = 430.354$ ,  $p < 0.001$ ). The two factors collectively explained 87.36% of the variance within the model. The two factors contained the same validity which was 0.874. The collective Cronbach's Alpha reliability for the two factors was 0.827. The results indicate that homebuyers may easily adapt to houses with prices acceptable to them.

**Table 2:** Factors analysis determining the demand for affordable housing in Malaysia

Factors	Component					
	Transportation Cost	Repayment Ability	Limitation on Consumable	Satisfaction	Neighbourhood Security	Debt Impact
Available of Public Transport	0.842					
Neighbourhood	0.827					
Down Payment	0.798					
Available of Own Transports	0.665					
Availability of Credit/Loan Facility	0.647					
Ability to Accommodate those with Mobility Restriction	0.636					
Operation & Maintenance Costs	0.618					
Household Income		0.910				
Interest Rate on Loan		0.900				
Quality of House		0.875				
Accessibility to Working Place		0.684				
Family Size		0.639				
Market/ Shopping Mall			0.824			
Type of House			0.803			
House Built-up Area			0.775			
House Price				0.892		
Adaptability				0.659		
Crime Rate					0.927	
Leasehold / Freehold House					0.578	
Availability of Mortgages						0.874
Access to Children School & Child Day Care Centre						0.870

The fifth component was named neighbourhood security because it comprises two factors that determined the demand for affordable housing in Malaysia. More specifically, it explained 9.96% of the variance within the model. The factor loading for the two factors was both 0.885. A second-order factor analysis combined these two factors into a single component named neighbourhood security. The Kaiser-Meyer-Olkin measure of sampling confirmed a good relationship between the factors (MSA = 0.500,  $\chi^2 (1) = 203.212$ ,  $p < 0.001$ ). The two factors collectively explained 78.29% of the variance within the model. The two factors contained the same validity which was 0.783. The collective Cronbach's Alpha reliability for the two factors was 0.720. The results mean that homebuyers were concerned about crime rate and whether the houses were leasehold or freehold when they purchased affordable housing.

The sixth component was named debt impact because it comprises two factors that determined the demand for affordable housing in Malaysia. More specifically, it explained 7.42% of the variance within the model. The factor loadings for the two factors was both 0.876. A second-order factor analysis combined these two factors into a single component named debt impact. The Kaiser-Meyer-Olkin measure of sampling adequacy confirmed a good relationship between the factors (MSA = 0.500,  $\chi^2 (1) = 177.036$ ,  $p < 0.001$ ). The two factors collectively explained 87.36% in this model. The two factors contained same validity which was 0.767. The collective Cronbach's Alpha reliability for the two factors was 0.695. The results indicate the availability of mortgages and convenient access to schools and child day care centres were factors that affect the demand for affordable housing.

## **CONCLUSION**

Affordable housing delivery has become a high priority for most countries as it plays a significant role in economic development and growth. While affordable housing is an abstract concept, examining the criteria that affects the housing delivery is critical. This research has investigated the demands of house buyers within the housing market by developing a framework for affordable housing. The framework critically examined the factors determining the demand for affordable housing. Policy makers, urban planners, developers, homebuyers, and contractors can use this framework in their housing decision-making processes.

Policy makers, urban planners, developers, and contractors should also be more concerned with the demand of affordable housing by median income earners within Malaysia especially in Kuala Lumpur, Penang and Johor. Majority of Malaysian living in cities have higher commitment for their basic necessities. This framework will also be able to provide insight in to their housing decision-making processes.

## ACKNOWLEDGEMENT

The research presented in this paper was supported in full by a grant from the “FRGS”; project: Analytical Investigation of Problems in Housing Supply in Malaysia; Project number: FRGS/1/2015/TK06/UTAR/02/2.

## REFERENCES

- Cheah, S. L. & Stefanie, J. A. (2017). Demystifying the affordable housing issue in Malaysia. *Bank Negara Malaysia Annual Report 2016* (pp. 90-98).
- Department of Statistics Malaysia [DOS] (2015). *Population and demography*. Putrajaya: Author.
- Khazanah Research Institute (2014). *The state of households*. Kuala Lumpur: Author.
- Kirkham, R. (2007). *Ferry and Brandon's cost planning of buildings*. Oxford: Blackwell Publishing.
- Li, H., Arditi, D., & Wang, Z. (2013). Factors that affect transaction costs in construction projects. *Journal of Construction Engineering and Management*, 139(1), 60-68.
- National Property Information Centre [NAPIC] (2017a). *Summary of existing stock for residential, commercial, leisure and industrial property sub-sector as at Q1-Q4 2016*. Putrajaya: Author.
- National Property Information Centre [NAPIC] (2017b). *Volume and Value of Property Transaction and Annual Changes 1990 – Q1 2017*. Putrajaya: Author.
- Osman, M. M., Ramlee, M. A., Samsudin, N., Rabe, N. S., Abdullah, M. F., & Khalid, N. (2017). Housing affordability in state of Johor. *Planning Malaysia*, 15(1), 347-356.
- Real Estate and Housing Developers' Association Malaysia [REHDA] (2016). *Assessing demand-supply dynamics in the Malaysian housing market*.
- Royal Bank of Canada and the Pembina Institute, (2013) Priced out: Understanding the factors affecting home prices in the GTA. *RBC Pembina Location Matters Series*.
- Undersupply of affordable houses seen to worsen (2017, March 24). *The Star Online*. Retrieved from <https://www.thestar.com.my/business/business-news/2017/03/24/undersupply-of-affordable-houses-seen-to-worsen/>
- US Department of Housing and Urban Development [US HUD] (2003). *Issue papers on demographic trends important to housing*.



**PLANNING MALAYSIA:**  
*Journal of the Malaysian Institute of Planners*  
**VOLUME 16 ISSUE 2** (2018), Page 119 - 130

## **FACTOR ANALYSIS ON HEDONIC PRICING MODEL ON OPEN SPACE AFFECTING THE HOUSING PRICE IN MELAKA AND SEREMBAN**

**M. Zainora Asmawi<sup>1</sup>, Mohammad Abdul Mohit<sup>2</sup>, Norzailawati Mohd. Noor<sup>3</sup>, Alias Abdullah<sup>4</sup>, & Tuminah Paiman<sup>5</sup>**

*<sup>1-5</sup>Kulliyyah of Architecture and Environmental Design,*  
INTERNATIONAL ISLAMIC UNIVERSITY MALAYSIA

### **Abstract**

Open spaces near residential area often labelled as development constraint since each residential development must provide 10 percent of open space from the total acreage according to Malaysia planning guidelines. Kuala Lumpur has noticeable lost in open space in residential area and this issue might happen with other neighbourhood states such as Negeri Sembilan and Melaka. Therefore, the purpose of this study is to find the resident perspective on the importance of open space while purchasing their housing property. As such, the aim of the research is to study and examine the characteristics of relationship between public open spaces and residential property value using GIS-Hedonic pricing modelling in the selected residential area in Seremban and Melaka. To find the gist of this study, factor analysis has been used to sum the hedonic pricing model output. Seremban and Melaka respondents have chosen the Importance of the House attributes in influencing the house price and Importance of open space following factors in influencing the house price. The research examined the relationship between the open space and house price at selected area in Seremban and Ayer Keroh. As found in the literature reviews, it validates that the relationship established in a positive pattern.

**Keyword:** residential and open space, factor analysis, hedonic pricing model

<sup>1</sup>Associate Professor at International Islamic University Malaysia. Email: zainora@iium.edu.my

## **INTRODUCTION**

The opportunity to make open spaces and authenticate environmental sustainability can have significances to liability management, land acquisition, land development and values. Appropriate use of the benefits of green infrastructure lead to substantial economic impacts. Although it has been recognised that it is impossible to comprehensively calculate the economic value of open spaces (Fausold, Charles, & Lilieholm, 1996), numerous models have been established to offer a framework to measure economic value of open spaces. Value of open spaces expands an area's general sense of attractiveness, helpful to attract visitors, and improve workers' productivity. Creating high quality open spaces also provides an opportunity to make a positive impression and deliver a sense of place that can attract investors and future residents alike. The social value of open space lies in the opportunities it provides for social interaction, social mixing and social inclusion. It can help facilitate the development of community ties and neighbourhood interaction. A public space provides an arena for the exchange of ideas, friendships, goods and skills. Public space is especially important for young children as it gives them play areas, leading to opportunity to make friends and to learn the rules of communal life.

## **LITERATURE REVIEW**

Plants have unique and collective artistic significance. Plants play an influential role in creating pleasant sceneries, buffering, differentiating and uniting spaces in between residential and industrial areas. Parks and green parks are meant for various recreational activities. Apart from recreational activities, open space also acts as acoustic isolation which buffer unpleasant sound between traffic roads and residential areas. The positive characteristics of open spaces are determinants of environmental factors influencing housing prices. However, economic valuation of the open space benefits is ambiguous as open spaces are public properties without a market price. Open space lacks value, hence it is not being considered in the cost-benefit analysis on the urban planning policies. Economic science has established detailed approaches to capture the value of environmental assets in monetary units. This value is calculated by observing people's behaviour, such as travel cost method. Other approaches such as contingent valuation, gather the value of the environmental asset by asking people about the cost they willing to pay in order to use or conserve the open space (Morancho, 2003).

There are few examples about the effect of open spaces towards house prices. Hui, Chau, Pun and Law (2007) examined the neighbouring and environmental features of a housing property on its market value in a high-rise, densely populated living environment. The results were similar with earlier studies. House owner were keen to pay more for apartments with a better view and better air. Though, green belt was not important variable on housing price. Kong, Yin, and Nakagoshi (2007) calculated the facility value of open space by

using GIS methods and landscape metrics in hedonic price modelling. As anticipated, the outcomes also established the positive facility impact of proximate open space on house price. Jim and Chen (2010) evaluated the external properties of neighbourhood open space on the transaction price of high-rise housing units in Hong Kong. The result showed that neighbourhood open space could boost the housing price by 16.88%, including 14.93% for availability and 1.95% for view (Biao, Gaodi, Bin, & Canqiang, 2012).

### **PROBLEM STATEMENT**

Open space has an indirect impact on property prices. The value of trees, water and open space is reflected in house prices (Luttik, 2000). There is a strong case for the preservation of existing green areas in residential areas and the creation of green areas in new urban development (Luttik J, 2000). Burgess, Monk and Whitehead (2007), demonstrated how green spaces enhance residential property values, concluding that different types of residential properties and different open space types affect values in different ways as shown below.

**Table 1.** How nearby green spaces can enhance property values

	Detached	Flat	Non-detached
City park	19.97%	7.54%	2.93%
Local park	9.62%	7.92%	9.44%
Open space	2.71%	4.70%	0.44%

*Source: RICS, 2007*

From high quality open space, open space helps to expand the value of any property near the area. Developers normally look for an opportunity to maximise land values through development. Open space facility creates a sense of place hence contributing to design quality. Undeniably, high quality open spaces in larger developments are used as the main of marketing materials.

### **AIM AND OBJECTIVES**

The purpose of the research is to learn and observe the relationship between public open spaces and residential property value by using the Hedonic pricing modelling in the selected residential areas located at Seremban, Negeri Sembilan and Ayer Keroh, Melaka. The research objectives are (i) to determine house attributes in influencing the house price and (ii) to identify the importance of open space in influencing the house price.

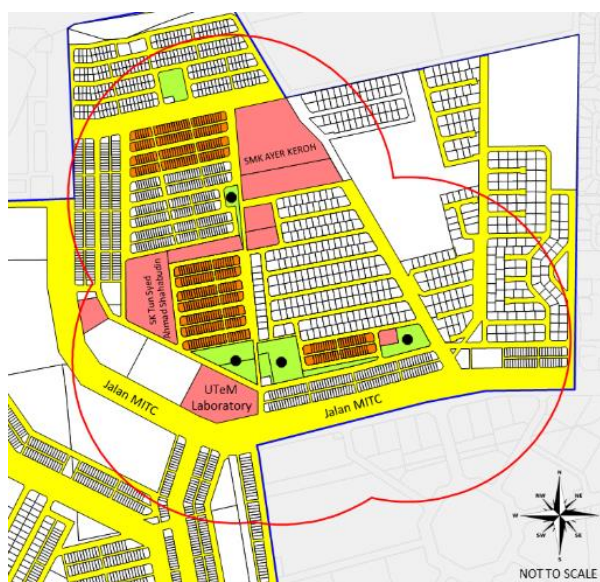
### **METHODOLOGY**

A total of 425 houses were identified in Taman Tasik Utama, Ayer Keroh, Melaka (Figure 2) and Taman Pulau Impian, Seremban, Negeri Sembilan (Figure 4). At 95% confidence level, 207 samples were collected based on  $\pm 5\%$  sample size. Both settlements were carefully chosen based on the following criteria: (i) the

areas have been developed for more than ten years; (ii) the areas have been constructed by well-known developers; (iii) the areas have a high density of population; (iv) the areas are located within highly urbanised areas, and (v) the availability of open space within the sites. A 400m radius has been drawn from the centre of open spaces as can be seen in Figure 2 and 4. The survey form was categorized under four sections: profile of respondent; house details; factors influence the house price; and hedonic pricing model in housing price. The study emphasizes on the understanding of house ownership, favourable elements of open spaces and importance of open space provision.



**Figure 1:** Example of open space that can be found close to the housing vicinity in Taman Tasik Utama. The residential area is 2.863 ha.



**Figure 2:** Taman Tasik Utama, Ayer Keroh, Melaka.





**Figure 3:** Example of playground that can be found at Taman Pulau Impian, Seremban.



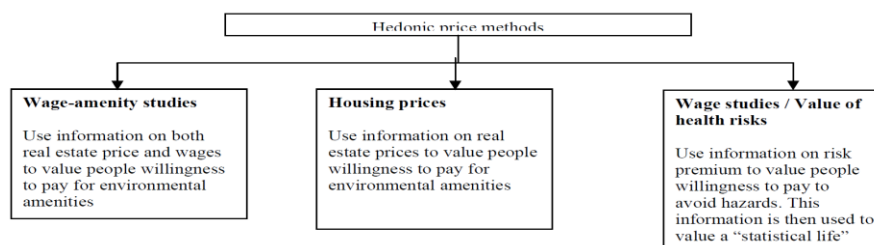
**Figure 4:** Taman Pulau Impian, Seremban. The residential area has only 1.271ha of open space but it covers the whole 400m radius of the residential units

### **HEDONIC PRICING MODELS**

For this study, Continuous Distance Variables has been used to collect the information for residents at Taman Tasik Utama and Taman Pulau Impian. The hedonic pricing model assess the price of each characteristic that describes a good by connecting the market prices among goods with varied amounts of the attribute. Assume a house consists of a set of varied attributes. The market price of the house can be assumed as the sum of prices for each characteristic defining the house. The function is  $P = f(\chi^1, \chi^2, \dots, \chi^k)$  where  $P$  is the market price of the house and  $\chi^1, \chi^2, \dots, \chi^k$  represent the characteristics of which it is formed. The partial derivative of the hedonic price function with respect to a certain characteristic,  $\chi^k$  equals the marginal price of that characteristic, which represents the marginal willingness to pay. Housing is essentially good with plenty of

characteristics that define it, such as total size and age. The price that the homeowner pays for a house is the sum of the prices of each of its characteristics.

Some of hedonic pricing models can be used to measure the influencing effect of these characteristics on the overall transaction price. These models are developed by using the coefficients generated from a regression analysis. This relationship can be described as ‘market price is a function of each tangible and intangible building characteristic and other outside influencing factors’ (Thompson, 2002). This is illustrated in the following equation: Market Price = f(tangible & building characteristics, other influencing factors). A regression analysis can then be calculated to determine the correlation for each of the characteristics measured against the transaction price. The correlation measurements are then used to create a hedonic pricing model which determine the expected price of the subject property (Thompson, 2002). The hedonic pricing models relies on information provided by households when they make their location decisions (Monson, 2009). The application of the method can be categorized under three heads: 1) wage-amenity studies 2) housing prices; 3) valuation of health risks using differences in wages (Monson, 2009; Haripriya & Vinish, 2004; Ridker & Henning, 1967) as shown in figure 4 below.



**Figure 5:** Applications of hedonic price method

## ANALYSIS

207 respondents participated in this study. The samples were collected within the 400m radius only. The sample size was sufficient based on the minimum sample size suggested by Sander and Haight (2012) which was 5 sample per variable. A sample size with more than 200 respondents was sufficient to generate the factor analysis. The analysis was generated in three stages, namely (i) descriptive statistics, (ii) reliability analysis and (iii) factor analysis. The dependent variable was the transaction price. 30 independent variables were categorized under three factors. The first factor, ‘Factors Influence Housing Price’ (HP) consists of eight independent variables which are strategic location, size of built up, attractive house design, provision garage and patio, good view, adequate infrastructure and utilities, adequate open space, road, and transportation network. The second factor, ‘Housing Attribute’ (Att) comprises of 10 independent variables which are location attraction, lot type end lot, lot type intermediate lot, lot type corner lot,

building condition, construction materials, built up original size, built up after renovation, house age and number of bedroom. The third factor, 'Open Space' (OP) consists of 12 independent variables which are easy access, frequency using open space, reason for going open space, availability active activity, availability passive activity, soft cape quality, adequacy facility, maintenance open space, location strategic, size adequate, facilities suitable to the users and cleanliness well kept.

### **DESCRIPTIVE STATISTICS**

Descriptive statistics delivered in this study was the frequency and percentages of profiles of respondents. The demographic profiles of respondents were described in terms of gender, age, occupation, monthly income and education level respectively. 56% of the respondents were male and 44% were female. The respondents' age ranged between 20 and above 60 years old. Most of the respondents were between 31 and 40 years old (30.4%) and 41 and 50 years old (29%). The survey questionnaires were selective towards homeowner or any household members who were knowledgeable about the details of their houses. 37.7% of the respondents were government workers, followed by private workers (29.5%) and self-employed (13%). Respondents' monthly income level ranged between RM8,001 and RM 12,000 (43.5%), between RM 5,001 - RM 8,000 (28.5%) and less RM 5,000 (13%). 41.5% of the respondents have diplomas while 25.6% of the respondents were bachelor degree holders.

### **RELIABILITY ANALYSIS**

The research attempts to identify factors in choosing the open space near residential areas among the house owner. Cronbach's Alpha was 0.627 with 28 degree of freedom, indicating internal consistency. The KMO index were 0.60 to 0.69, thus suggested sample adequacy. The result suggested that the data was reliable for further analysis.

### **FACTOR ANALYSIS**

Factor analysis was generated to discover the factors in choosing open space near residential area among the house owner at Taman Tasik Utama, Ayer Keroh and Taman Pulai Impian, Seremban residential areas. Bartlett's test of sphericity and the Kaiser-Meyer-Olkin measure of sampling adequacy were used to determine the factorability of the matrix as a whole. Bartlett's test of sphericity was significant ( $p < 0.001$ ,  $p = 0.000$ ) as shown in Table 3. In addition, the Kaiser-Meyer-Olkin measure was 0.627 which is greater than 0.6. Based on these result, factorability was assumed (Sander & Haight, 2012). Factor Analysis was generated to examine factors that affecting a decision of house owners on open space near their property.

**Table 3: KMO and Bartlett's test**

Kaiser-Meyer-Olkin Measure of Sampling Adequacy.		.627
Bartlett's Test of Sphericity	Approx. Chi-Square	600.962
	df	28
	Sig.	.000

The initial communalities represented the relation between the variable and all other variables before rotation. If many or most communalities were low (< .30), a small sample size was more likely to distort results. Table 4 lists 8 factors that had initial communalities above .30, which was good.

**Table 4 Communalities**

	Initial	Extraction
Att2	.612	.708
Att3	.614	.823
OP2	.451	.374
OP3	.514	.492
OP4	.601	.695
OP5	.549	.528
OP8	.233	.533
OP9	.247	.374

Extraction Method: Principal Axis Factoring.

The Total Variance Explained in Table 5 below showed that there were three components with initial Eigenvalues more than 1.0. The first component explained 31.226% of the total variance, followed by 14.123 and 11.246 respectively.

**Table 5 Total Variance Explained**

Factor	Initial Eigenvalues			Extraction Sums of Squared Loadings			Rotation Sums of Squared Loadings <sup>a</sup>
	Total	% of Variance	Cumulative %	Total	% of Variance	Cumulative %	Total
1	2.899	36.236	36.236	2.498	31.226	31.226	2.201
2	1.489	18.610	54.846	1.130	14.123	45.349	1.845
3	1.369	17.109	71.955	.900	11.246	56.595	1.001
4	.903	11.286	83.241				
5	.543	6.790	90.031				
6	.340	4.254	94.285				
7	.239	2.985	97.270				
8	.218	2.730	100.000				

- a. Extraction Method: Principal Axis Factoring.
- b. When factors are correlated, sums of squared loadings cannot be added to obtain a total variance.

The factor Pattern Matrix as listed at Table 6 below contain the coefficients for the linear combination of the variables. A total of 27 items were eliminated because they did not contribute to a simple factor structure and failed to meet a minimum criterion of having a primary factor loading of .3 or above.

**Table 6. Pattern Matrix**

Factor	1	2	3
OP4	.847		
OP5	.741		
OP3	.646		
OP2	.541		
Att3		.906	
Att2		.824	
OP8			.733
OP9			.593

- a. Extraction Method: Principal Axis Factoring.
- b. Rotation Method: Promax with Kaiser Normalization.
- c. Rotation converged in 5 iterations.

## RESEARCH FINDINGS

### **Factors in Influencing the House Price for Seremban and Ayer Keroh**

Based on the factor extraction, it was identified that the following factors were important determinants in buying a house. In ‘Housing Attribute’, the variables were lot type end lot, lot type intermediate lot. The respondents also chosed frequency using open space, reason for going open space, availability active activity, availability passive activity, soft cape quality, maintenance open space, and location strategic as the main criteria. There are two economic contributions of open space. First, open space often increases nearby property values which contribute to greater tax revenue for the municipal council. Second, the area avoids costs associated with providing municipal services to a residential area that might otherwise be located on the site (Moore, Graefe, Gitelson, & Porter, 1992). Home purchasers are usually prepared to pay more for their property to be located close to open space (National Park Service, 1995). A study by Morancho (2003) found that 77.7% of home buyers valued natural open space as essential in planning residential areas. However in some cases where parks are poorly maintained, noisy, or congested, these open spaces are unfavourable to the homebuyers. Previous studies (National Park Service, 1995; Morancho, 2003) record that surges in property values also depend on the capability of developers

to provide access to open spaces and views facing the open spaces given the difficulty to offer open spaces in the planned residential areas.

### **House Attributes in Influencing House Price**

When it comes to individual properties, house prices are determined by a combination of many different factors. From the analysis, intermediate lot houses have been chosen as one of highest factor in buying a house. In general, intermediate lot has the lowest price while corner lot house is more expensive since it has more land size compared to the others. Apart from intermediate lot, respondents from Seremban and Ayer Keroh also preferred end lot type of houses among the best choices to invest. There exists a diversity of different housing lot types, and it is important to recognise and understand the differences of each type before purchasing the property. The intermediate lot is the most common lot type because it faces one street. The intermediate lot is situated between houses on the left and right side, facing the street with a plot behind the house. Sometimes there are differences of lot sizes and distances between neighbours. An end lot is a lot sitting in a dead-end street without access to any vehicles. The lots normally have larger plot, less traffic, and more privacy. End lots are typically favoured because of the perceived safety of the street for children and the larger yards. The end lot is highlighted by the real estate agent as a huge positive as it gets more sales price.

### **Importance of Open Space in Influencing House Price**

Open space can be considered as an outdoor playroom within the housing area. It is where people come to relax and enjoy the urban experience. A place for various activities including entertainment, sport activities, and most importantly a place for walking or sitting-out (Rossi-Hansberg, Sarte, & Owens, 2010). It is tough to measure the impact of open space on housing values as they are many types of houses and uses of open space, the numerous uses of the adjacent land, and other factors (Crompton, 2001). The respondents selected five characteristics in choosing open space near their residential area. Among the characteristics were frequency using open space, reason for going open space, availability active activity such as badminton and basketball courts, availability passive activity, soft cape quality, maintenance open space, and location strategic. In regard of the characteristics, the provision of high quality open spaces help to establish the character of a new residential area and offer a place for community gatherings and other communal activities (Monson, 2009). There is a 20% growth in the worth of housing properties adjoining or fronting a passive-use open space. The worth is higher if the open space is large, well maintained and mainly used for passive activities. The worth is lower for properties neighbouring smaller open space or open space that are used for active activities, such as football fields. Finally, the distance from the properties to the the open space also plays a role in

choosing a housing property. House owners living closer to open space enjoy a more benefit than houses owners living further away from the open space.

### **CONCLUSION**

The research examines the relationship between the open space and house price at selected area in Seremban and Ayer Keroh. In favour of the literature reviews, the findings indicate the importance of open space availability and accessibility in buying a property. The international practices recommend that the closer the house to an open space, the more expensive the selling value. Consequently, the results gathered on the sites also reflect the same pattern, although the relationship is weak. In the local context, the respondents did not prioritize the aspects of physical planning requirement such as the size and location. They preferred the aspect of park management. The respondents considered availability of active activity, availability of passive activity, soft cape quality, maintenance of open space, and strategic location as important elements to support the quality of open space which then influence the housing prices.

### **ACKNOWLEDGEMENT**

This work was financially supported by the Ministry of Higher Education under the Fundamental Research Grant Scheme (FRGS) no FRGS/2/2014/SS08/UIAM/02/1.

### **REFERENCES**

- Biao, Z., Gaodi, X., Bin, X., & Canqiang, Z. (2012). The effects of public green spaces on residential property value in Beijing. *Journal of Resources and Ecology*, 3(3), 243-252.
- Burgess, G., Monk, S., & Whitehead, C. (2007). The provision of affordable housing through section 106: The situation in 2007. Cambridge, UK: RICS.C.W.
- Thompson, C. W. (2002). Urban open space in the 21st century. *Landscape and Urban Planning*, 60, 59-72.
- Fausold, C. J. & Lilieholm, R. J. (1996). The economic value of open space. *Land Lines*, September 1996.
- HariPriya, G. & Vinish, K. (2004). *Can markets value water scarcity and quality: an analysis using hedonic approach*. Project report submitted to the South Asian Network for economic institutions, August 2004.
- Hui, E. C. M., Chau, C. K., Pun, L., & Law, M. Y. (2007). Measuring the neighboring and environmental effects on residential property value: Using spatial weighting matrix. *Building and Environment*, 42(6), 2333-2343.
- John Crompton, J. L. (2001). Perceptions of how the presence of greenway trails affects the value of proximate properties. *Journal of Park and Recreation Administration*, 19(3), 33-51.

- Kong, F. H., Yin, H. W., & Nakagoshi, N. (2007). Using GIS and landscape metrics in the hedonic price modeling of the amenity value of urban green space: A case study in Jinan City, China. *Landscape and Urban Planning*, 79, 240-252.
- Luttik, J. (2000) The value of trees, water and open space as reflected by house prices in the Netherlands. *Landscape and Urban Planning*, 48(3-4), 161-167.
- Monson, M. (2009). Valuation using hedonic pricing models. *Cornell Real Estate Review*, 7, 62-73.
- Moore, R. L., Graefe, A. R., Gitelson, R. J., & Porter, E. (1992). *The impact of rail-trails: A study of users and nearby property owners from three trails*. Washington, DC: National Park Service.
- Morancho, A. B. (2003). Hedonic valuation of urban green areas. *Landscape and Urban Planning*, 66(1), 35-41.
- National Park Service (1995). *Economic impacts of protecting rivers, trails and greenway corridors: A resource book*. Washington, DC: Author.
- Ridker, R. G. & Henning, J. A. (1967). The determinants of residential property values with special reference to air pollution. *The Review of Economics and Statistics*, 49(2), 246-57.
- Rossi-Hansberg, E., Sarte, P., & Owens, R. (2010) Housing externalities. *Journal of Political Economy*, 118(3), 829-858.
- Sander, H. A. & Haight, R. G. (2012). Estimating the economic value of cultural ecosystem services in an urban area using hedonic pricing. *Journal of Environmental Management*, 113,194-205.





## **MAPPING THE LANDSCAPE CHARACTERS ALONG A RURAL ROUTE FOR TOURISM**

**Nur Amirah Abdul Wahab<sup>1</sup>, Khalilah Zakariya<sup>2</sup>, Putri Haryati Ibrahim<sup>3</sup>,  
& Ilyani Ibrahim<sup>4</sup>**

<sup>1,2,3,4</sup> *Kulliyyah of Architecture and Environmental Design,*  
INTERNATIONAL ISLAMIC UNIVERSITY MALAYSIA

### **Abstract**

The scenic landscape characters along driving routes have been acknowledged by numerous studies to be important in planning for rural tourism. Landscape characters shape the setting and ambience of a place. This study focuses on mapping the landscape characters along a rural route as a way to identify potential characteristics to be conserved and enhanced for tourism. The case study area covers the Kuala Selangor to Sabak Bernam route, which is part of a federal route that runs along the west coast of Peninsular Malaysia. Using landscape character mapping, observation and landscape character assessment (LCA), mapping was conducted to identify and analyse the landscape characters along the route based on the physical, cultural and environmental attributes. It is found that each segment along the route has its own attributes and the physical images based on their activities and environment. This study found that the rural route has a unique and distinctive rural landscape identity that needs to be integrated with the planning of infrastructure and road system, in order for it to increase tourism activities.

**Keyword:** landscape character assessment (LCA), rural tourism, tourism route

<sup>2</sup>Associate Professor at International Islamic University Malaysia. Email: khalilah@iiu.edu.my

## **INTRODUCTION**

Rural tourism is widely acknowledged by the tourism industry as activities that contribute to the income generation of rural areas. Planning for rural tourism also encourages the conservation of cultural and natural heritage, such as traditional villages, cultural landscapes and landscape features. The rural setting becomes the main attraction for tourists, where the selection of scenic driving routes is often selected based on the experience that the route can offer.

Through the rural tourism activities, visitors have the opportunity to experience the village cultures with the wide range of attractions and activities offered by the local people. Some of the most common rural tourism activities are those related with agriculture, nature and open spaces, and settings with low-level of development, traditional houses and the local lifestyles (Irshad, 2010). The rural setting attracts tourists from the urban area because it offers them a view of the natural environment, opportunities to engage in local activities and experience culture, traditions, history and heritage of a place. Jaal and Abdullah (2012) suggested that the landscape characters are part of the key elements that shape the cultural identity and foster the quality of life of the rural community. Rural tourism characters could benefit the local people in terms of income generation by attracting the visitors to their village and promote their local products.

While the benefits of rural tourism have been broadly recognized by various researchers and agencies, rural attractions are often located far away from the city and time-consuming to be accessed. As a result, visitors tend to use the faster routes, such as the highways. Consequently, the passive flow of visitors into the rural areas results in less vibrant rural tourism activities. With a holistic landscape planning, the rural route can actually offer a more scenic journey while at the same time offer activities for visitors to make their road trip more fulfilling and enriched.

The aim of this study is to identify the landscape characteristics of the rural route along Kuala Selangor and Sabak Bernam, which has potential as a tourism route connecting the states of Selangor and Perak. The landscape characters are mapped in order to recognize the major characteristics that contribute to the setting and rural image of this route with reference to the landscape character assessment (LCA).

## **BACKGROUND STUDY**

### **Indicators of the Vibrancy of Rural Area**

The location of rural attractions that is far from the hustle and bustle of the city is one of the factors that make the rural area vibrant and appealing. According to Hasuike, Katagiri, Tsubaki and Tsuda (2013), integrated road from one village to

another village or direct routes from the urban areas could attract visitors to visit the rural areas. Other than that, rural areas that are located near to the tourist attractions encourage visitors to visit without the concern on traffic problems that tend to take place in urban areas.

The scenic beauty of the landscape that can be experienced along the rural routes have huge potentials to attract people to travel by choosing the rural routes instead of conventional highways. A study by Aranzabal, Schmitz and Pineda (2009) indicates that the socioeconomic framework to maintain the rural area should relate the aesthetic values of the area and the ecological function. The natural environment and the built environment of the area play important roles to attract tourists.

According to Mizukami et al. (2012), the symbolic values of an area such as special spaces and monuments could act as the landmarks that allow the orientation of space and time. This means that villagers can also play their roles to increase the number of tourists by promoting their unique lifestyle and architectural identity that enhance the sense of place of the rural areas.

In order to attract more visitors to use the rural routes, the facilities and infrastructures need to be upgraded and integrated to more sufficient and functional. One of the mostly used facilities along a driving route is the rest areas (*Rehat & Rawat – RnR*), which commonly incorporate petrol station, toilets, prayer rooms, food stalls and parking spaces. Another facility needed by tourists is accommodation, such as hotels or homestays, which could be the rural houses. The tourists could be offered to stay with the local people to experience the rural life.

The natural setting, built environment and infrastructure also contribute to the rural tourism industry (Lo, Mohamad, Songan, & Yeo, 2012). Natural setting includes forests, hills, beach, and others, as well as agricultural lands. The built environment is composed of traditional houses, landmarks, religious institutions and other structures. Therefore, the scenic beauty of the landscape setting, the facilities and the infrastructure at the rural areas influence the vibrancy of the rural areas along the routes (Table 1).

**Table 1:** The criteria and indicators of the rural routes

Criteria	Indicator(s)
Quality of scenery	Mountains, lakes, rivers, coastline, panoramic views
Strength of attractions	Number of attractions & quality of each
Potential for recreational activity	Trekking trails, fishing locations, amenities, activities
Potential for product clustering	Combined number of attractions, amenities, activities
Range of accommodation options	Number of different types of accommodation category
Range of tourism amenities	Forest recreation area, agricultural parks
Distinctive culture and heritage	Number of museum, cultural events, historic links

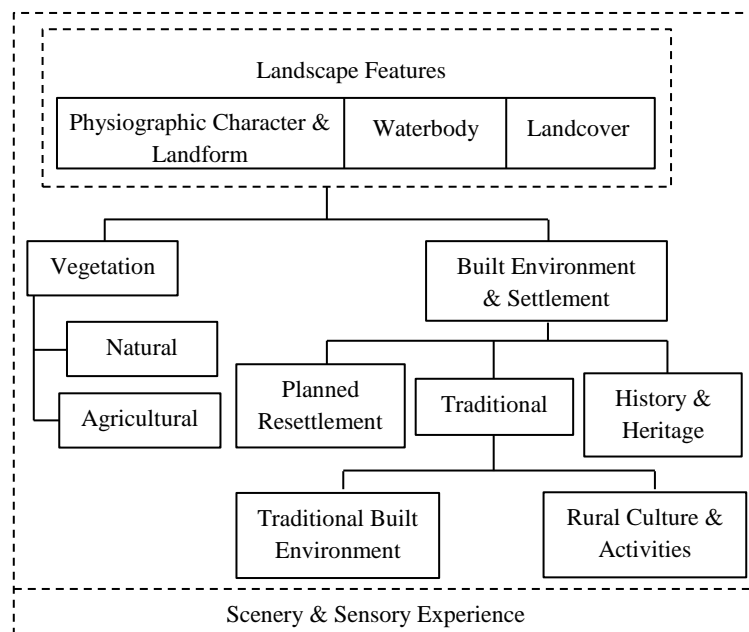
General services and infrastructure	Dinning, shopping facilities, TICs, road quality, water
Quality of environment	Absence of litter, water pollution, attractive streetscape
Support from official agencies	Previous tourism investment, efforts to organize tourism
Active community organisation	Local development projects undertaken, sustained effort
Tourism marketing track-record	Promotional brochures, booking systems, publicity effort
Accessibility to main tourism centres	Within 3 hours travelling time
Proximity to international entry points	Within half a day's travelling time

### **Rural Landscape Character Assessment Criteria**

With reference to the existing landscape characters' assessment frameworks by National Landscape Department (2012), the landscape feature is first categorized in terms of its physiographic character and landform, waterbody and landcover. The identification of landscape characters is important in tourism planning because tourism and environment has a close relationship for conservation and ensuring minimal environmental implication (Prabhakaran, Nair, & Ramachandran, 2014). The natural environment needs to be conserved as it benefits not only environmentally but economically and socially. Figure 1 shows the components of the rural landscape character assessment that was used as the guideline to collect the data for this study.

Vegetation is another important component that needs to be sustained for rural tourism. The planning of rural tourism considers the landuse, housing, transportation and environmental protection that include the farmers, agriculture and villages (Diao, 2011). On the other hand, the built environment and settlement is also significant to the success of the rural tourism. The built environment of the rural area possesses heritage values, which strengthen the sense of place.

Besides, the human-environment interaction is one of the most important interactions in the cultural landscape that provide the structural and harmonious combination of people and place (Shamsuddin, Sulaiman, & Amat, 2012). Scenery and sensory of all the landscape features contribute to visitors' experience. As mentioned by (Ghasemi and Hamzah, 2014), the tourist activities such as river cruising, wildlife watching, sunrise and sunset observation could provide scenic and sensory experiences to the tourists. Hands-on activities such as farming and gardening offer new experiences to the tourists to invigorate their visits (Diao, 2011).



**Figure 1:** Conceptual framework of rural landscape character assessment  
Source: Zakariya, Ibrahim, & Abdul Wahab (2017)

The rural landscape character of the landform, waterbody, landcover, visual sensitivity, visual unity and visual quality will be valued based on the observation. All of the mentioned landscape characters deliver significant values and actions need to be taken for them to be more recognised and preserved.

## METHODOLOGY

The method that is adopted for this study include landscape characters' assessment through a site inventory, observation and landscape character mapping. The site inventory was conducted from Kuala Selangor to Sabak Bernam using Federal Route 5, with a total distance of approximately 64 kilometres. The mapping was done to identify and classify the observed landscape characteristics found along the route. The data collected document the significant landscape features found in the five segments of the route, which then were divided according to the towns where the route passes through. The five segments were: (i) Kuala Selangor, (ii) Tanjung Karang, (iii) Sekinchan, (iv) Sungai Besar, and (v) Sabak Bernam. Other than recording the landscape features using a camera and GPS, the researchers also stopped at any area that was promoted as tourist attractions based on a preliminary study and places that have potentials to attract tourists. The characteristics of the area were inventoried using a checklist that was developed based on the literature review of rural landscape

characters for tourism. The GPS coordinates were then gathered and converted into a map.

## RESULTS

The results of the mapping are explained in a manner that describe the landscape features, vegetation, and built environment and settlement according to the five segments along the route (Figure 2).

### Landscape Features

The major landscape features of Kuala Selangor – Sabak Bernam route is made up of the physiographic characters and landform of the area, which is predominantly of flat land and a hill. Most of the land coverage in Kuala Selangor to Sabak Bernam is flat land, except for Bukit Malawati, a hill that marks the highest point in the area. Bukit Malawati's historical significance has also attracted tourists to visit Kuala Selangor, while at the same time offered tourists to experience the bird's eye view and vista of the whole Kuala Selangor areas and the coast of the Melaka Straits. The main water bodies along these routes are the Selangor River, mirror beach at Kampung Sasaran, Bagan Nakhoda Omar, Pantai Redang and others. This estuary becomes the main source of income to the local people. The majority of the community members in this area work as fisherman. Therefore, tourists could experience the fishing activities and see the lifestyle of the fishermen in this area that maintains the traditional style of fishing activities.

### Vegetation

The study found that Kuala Selangor has abundant vegetation setting. The mangrove area is part of the Kuala Selangor that is rich with biodiversity and scenic nature park, which is already listed as a tourist attraction and has consistently received visits from tourists and visitors. Other than that, agricultural settings along the routes are the coconut and oil palm plantations. These plantations are commonly sighted in the lowland areas of Kuala Selangor, Tanjung Karang and Sabak Bernam area. Majority of the coconut trees are planted near the coastal area, suitable with the sandy soil. On the other hand, the oil palms are planted on the lands beside the routes due to the land suitability of the peat soil. However, the Sekinchan and Sungai Besar area change the views to the paddy and coconut plantations along the routes. Paddy plantations attract visitors since it is well-known at the northern area of Peninsular Malaysia. The paddy fields along this route can be considered to be the closest to an urban area. Another famous attraction of Kuala Selangor is Kampung Kuantan and Buklit Belimbing where visitors can see fireflies that inhabit the Berembang trees (*Sonneratia caseolaris*).

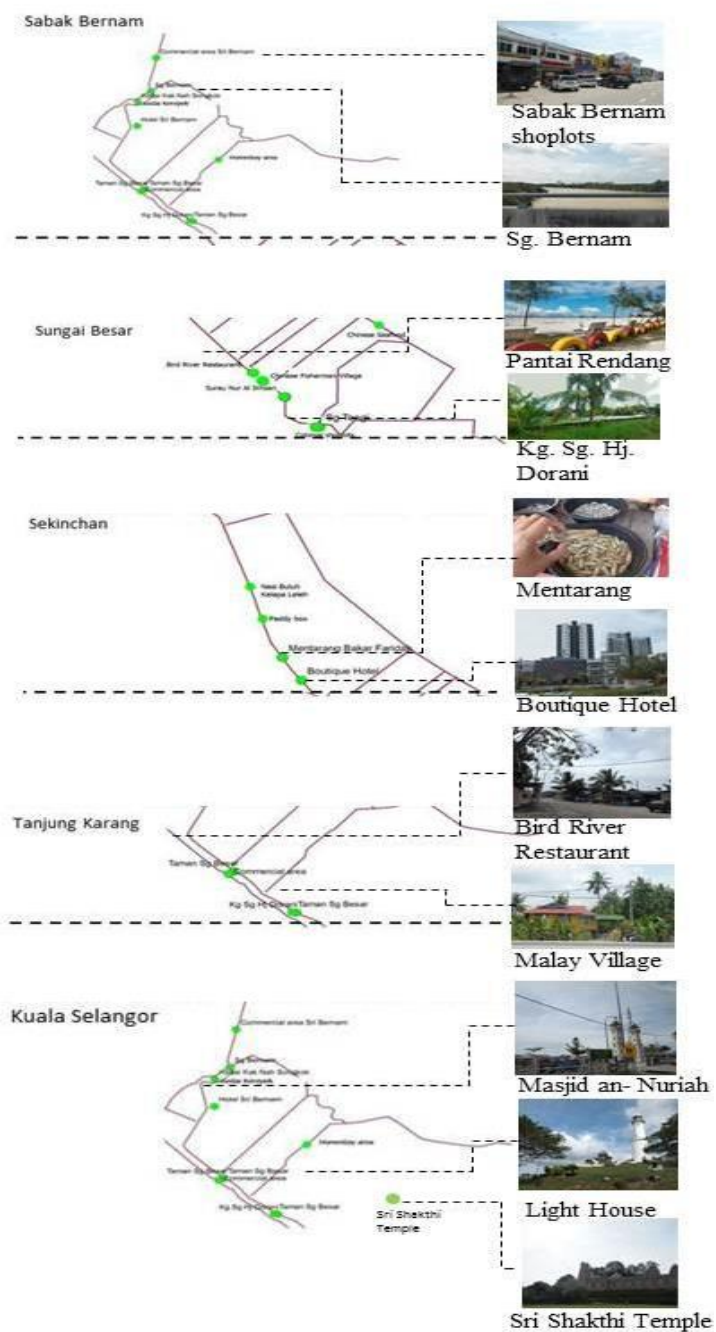
### **Built Environment and Settlement**

The Kuala Selangor, Tanjung Karang, Sekinchan and Sungai Besar are the Malay community areas with houses that maintain the rural identity of the area, such as the traditional ‘kampung-house’ architecture. Kuala Selangor, Tanjung Karang and Sekinchan have the traditional built environment of the Chinese fishermen villages and settlements, especially at the coastal area. The Indian settlements, mostly located near Bukit Rotan, maintains its traditional housing area with scattered settlement pattern. The rural culture and activities in Kuala Selangor and Tanjung Karang can be seen to be practiced by mostly the Chinese and Indian communities. However, the Sekinchan, Sungai Besar and Sabak Bernam areas are starting to be urbanized with presence of terrace houses and high rise buildings as the planned resettlement. Besides the unique rural settlements, Kuala Selangor is also rich with history and heritage. For example, the lighthouse located on top of Bukit Malawati was built in 1907, which previously served the fort. Other than that, the Sri Shakthi Temple located in Bukit Rotan is one of the oldest Hindu temple in Kuala Selangor. This area also has a heritage golf club, which Kelab DiRaja Kampung Kuantan, since 1910 and the building has been conserved until today. The Sekinchan and Sungai Besar area are known for the homestay programs that maintain the rural lifestyle for visitors to experience. There are also many local stalls that promote the local products such as *mentarang*.

### **DISCUSSION AND CONCLUSION**

The landscape characters observed along the Kuala Selangor – Sabak Bernam route is found to influence the vegetation, agricultural activities, economic activities, the built environment and eventually the rural lifestyle. The most significant characters along the route are the low landform of the landscape features. This type of geographical setting is dominant in this area. Hence, the local authority and ministry should recognise and control the landuse at this area to be harmonized with the rural landscape.

The less significant character along this route is the history and heritage. Along the routes there are only Bukit Melawati area that has been conserved as a heritage site. The other places are rich with local culture but currently not highlighted as core attractions. Hence, the relevant tourism agencies and local people should work together to promote the history and local heritage in the five areas along the route.



**Figure 2:** Mapping diagram of rural landscape characters



For this case study, Bukit Malawati is the landmark of the area because it is the only hill surrounded by flat land and low-land areas. The route is bordered by the same type of agricultural plantations (oil palm and coconut) and intermittently contrasted by the open views towards the paddy fields in Sekinchan and Sungai Besar. Since this route is located on the west-coast of Selangor, it has a distinctive water body image made of the coast, mangrove and the river. The combinations found in these landscape characters are unique because they are influenced by the site's geographic and physiographic characters, which cannot be reproduced elsewhere. Although another place in Malaysia may have the similar landscape characters, nonetheless, the local culture would most likely be different. Hence, all of these characters will attract the visitors to visit the area while increasing the local people's income and promoting the local products.

This study recommends that in order for this area to become a scenic tourism route, activities that relate to its landscape characters can be introduced as a way of strengthening its sense of place. Attractions and stop-points near the road side need to be integrated into the infrastructure, while at the same time, maintaining the setting and ambience of the area. This article concludes by emphasizing that landscape characters are integral in the planning of tourism route.

#### **ACKNOWLEDGEMENT**

This study was supported by the Fundamental Research Grant Scheme under the Ministry of Higher Education Malaysia (FRGS16-018-0517)

#### **REFERENCES**

- Aranzabal, I., Schmitz, M. F., & Pineda, F. D. (2009). Integrating landscape analysis and planning: A multi-scale approach for oriented management of tourist recreation. *Environmental Management*, 44, 938-951.
- Diao Z. (2011) Study on current situation and development strategies for rural tourism in China. In Q. Zhou (Ed.), *Advances in applied economics, business and development ISAEED 2011* (pp. 186-190). Heidelberg: Springer.
- Ghasemi, M. & Hamzah, A. (2014). An investigation of the appropriateness of tourism development paradigms in rural areas from main tourism stakeholders' point of view. *Procedia - Social and Behavioral Sciences*, 144, 15-24.
- Hasuike, T., Katagiri, H., Tsubaki, H., & Tsuda, H. (2013). Interactive multi-objective route planning for sightseeing on Time-Expanded Networks under various conditions. *Procedia Computer Science*, 22, 221–230.
- Irshad, H. (2010). *Rural tourism – An overview*. Government of Alberta: Agriculture and Rural Development.

- Jaal, Z., & Abdullah, J. (2012). User's preferences of highway landscapes in Malaysia: A review and analysis of the literature. *Procedia - Social and Behavioral Sciences*, 36, 265-272.
- Mizukami, M. D. G., Ribeiro, L. R. D. C., Sandseter, E. B. H., Ali, S. M., Rostam, K., Awang, A. H., ...& Ahmad, C. (2012). Towards a compatible landscape in Malaysia: An idea, challenge and imperatives. *Procedia - Social and Behavioral Sciences*, 15, 70-82.
- Lo, M-C., Mohamad, A. A., Songan, P., & Yeo, A. (2012). Positioning rural tourism: Perspectives from the local communities. *International Journal of Trade, Economics & Finance*, 3(1), 59-65.
- National Landscape Department (2012). *Manual penilaian karakter landskap Malaysia*. Kuala Lumpur: Kementerian Perumahan dan Kerajaan Tempatan.
- Prabhakaran, S., Nair, V., & Ramachandran, S. (2014). Community participation in rural tourism: Towards a conceptual framework. *Procedia - Social and Behavioral Sciences*, 144, 290-295.
- Shamsuddin, S., Sulaiman, A. B., & Amat, R. C. (2012). Urban landscape factors that influenced the character of George Town, Penang Unesco World Heritage Site. *Procedia - Social and Behavioral Sciences*, 50, 238-253.
- Zakariya, K., Ibrahim, P. H., & Abdul Wahab, N. A. (2017, February). Landscape character assessment for Malaysia's rural landscape: A conceptual framework. *Persidangan Kebangsaan Masyarakat, Ruang & Alam Sekitar (MATRA) 2017*. February 23-24, 2017, Penang, Malaysia.



## **GEN Z'S ACTIVITIES AND NEEDS FOR URBAN RECREATIONAL PARKS**

**Nurfaezah Ghani<sup>1</sup>, Mazlina Mansor<sup>2</sup> & Khalilah Zakariya<sup>3</sup>**

<sup>1,2,3</sup>*Kulliyyah of Architecture and Environmental Design*  
INTERNATIONAL ISLAMIC UNIVERSITY MALAYSIA

### **Abstract**

A public recreational park for youth is important in promoting leisure activities for their health. Engagement with outdoor activity contributes to healthy growth development physically, mentally and socially. Youth prefers places that offer favourable facilities where they can express themselves with presence friends. The study focuses on Generation Z youth (Gen Z), who are born between the mid of the 1990s through the late 2000s. The study investigates Gen Z activities and needs of recreational parks in Kuala Lumpur. The study obtained 564 respondents who lived in five strategic zones in Kuala Lumpur. Their responses were statistically analyzed using the SPSS. Results showed that the Gen Z frequented recreational parks near their homes. Titiwangsa Lake Garden, KLCC Park and Kepong Metropolitan Park are among their place preference. A recreational park for them should have more natural attributes and meet their active lifestyle. The places encourage them to have an active engagement and positive socialization with others.

**Keywords:** public recreational parks, generation Z, youth, activities, needs

<sup>1</sup>Student at International Islamic University Malaysia. Email: nurfaezahghani91@gmail.com

## **INTRODUCTION**

Youths in Malaysia are an important asset of the future because they have the potential to achieve success in various aspects. Currently, a majority of early youths in Malaysia is among the generation Z (Gen Z). They were born between 1995 to 2001. The lifestyle and health of Gen Z need to be addressed in order to produce proactive youths, equipped with skills, talent and creativity. Leisure activities among youths are diverse and they play an important role in forming of their self-perceptions. Hence, youths need access to the outdoor environment to support their healthy development (Latifiyan & Salayati, 2015). Urban recreational park is an alternative place, other than city center (shopping mall, school and home environment) to promote outdoor leisure activities among Gen Z youths. It is a place that they can gather with friends, be alone, and learn.

Nonetheless, there is still a lack of recreational areas in Kuala Lumpur for Gen Z youth. Design of recreational park gives more priority to users such as family group and children as compared to youths' needs (Makinen & Tyrvaiven, 2008). Gen Z needs space that they can enjoy and have fun doing their favourite activities. The lack of appropriate space of leisure is feared to contribute to unhealthy activities and social problems among youths. Design attributes for youths' recreational area include location of parks, facilities and maintenance aspects need to be improved in order to encourage them to have an active engagement with the outdoor environment.

The study aim to determine the criteria of space by identifying the relationship between the leisure time activities and the needs of Gen Z youth. The paper presents findings that explore the use of parks' in Kuala Lumpur by Gen Z, and the types of activities needed of public recreational parks. The study is important to reveal needs and factors that can make recreational parks more attractive to fulfil this generation's needs.

## **LITERATURE REVIEW**

A *generation* is a group of people born in the same era, shaped by the same time and influenced by the same social markers. Generation Z is today's children, teenagers and youths. They are the first generation of the 21st century and was born from the mid of the 1990s to the late 2000s (Sladek & Grahinger, 2014). Gen Z is also known as digital natives, iGen, Post-Millennials, Centennials, or Plurals. Their behavior is said to be quite different from previous generations. They are characterized as 'Digital Natives', as they are always following the development of information and communications technology (ICT). They have inclination to learn new things in many ways based on their needs (McCrinkle & Wolfinger, 2008; Rabe et.al 2017) A statistic in Malaysia projected that the population of Gen Z will increase from nearly 3 million in 2016 to 5.5 million in 2020 (Department of Statistic Malaysia, 2016). Gen Z's world in terms of lifestyle and inspiration are largely shaped by the internet and the technology.

They spend an average of 7.5 hours using media and looking at the screen (Rideout, Foehr, & Roberts, 2010). As such, there is a tendency that they prefer sedentary pursuits rather than sport activities, or actively participating in games at leisure time (Poh, Safiah, Tahir, Siti Haslinda, & Siti Norazlin 2010; Wilson, 2006). It is claimed that their participation in sports or physical activities is low (Lim et al., 2016). For example, a study found that only 22% of Malaysian teenagers (15-18 years old) participate in regular sport or physical activity (at least 4200 minutes per week) (Aminuddin et. al., 2009). It was confirmed that those who prefer to stay indoor during leisure time afflict themselves to sedentary behaviour (Biddle, Marshall, Gorely, & Cameron, 2009). A sedentary behavior often begins at childhood and adolescence stages. Without intervention, the behavior will continue into adulthood, resulting in many chronic diseases. Regular physical activity, recreational activities and healthy eating habits are the mitigation steps for Gen Z to prevent the chronic diseases in their adult life.

Research has shown that youths' outdoor leisure activities give positive effects towards their health, growth development and attitudes (Rabe et al., 2017). A recreational park is an ideal place for Gen Z to be active due to its natural attributes and facilities. It is suggested that the majority of users in recreational park is among youth generation (Rabe et al., 2017). Leisure activities in public recreational parks are preferred because it is accessible without any entrance fee. It is suggested that a high frequency of recreational park usage by youths is an indicator that the design features of the park is successful. It means that preference of youths for a recreational park is influenced by the criteria of the parks (Ngesan, Karim, Zubir, & Ahmad, 2013; Abd-Latif, Nor, & Omar-Fauzee, 2011). For example, the youths are more concerned about the condition of equipment and the natural views because these criteria influence their mood and feelings to play and enjoy activities (Kahiruddin, Mohd Yunus, Mydin, & Ujang, 2015). Distance of play area with their residential areas also influence their choice to frequent a park (Danis, Sidek, & Yusof, 2014; Zulkia, Zainol, Zainol, & Nordin, 2014). Typical types of recreational park facilities, compatible with the youths comprise of baseball fields, basketball courts, picnic areas, open lawns, jogging tracks and many more. Youths' demands on the types of facilities change over time (Rabe et al, 2017). Currently trending activities that magnetize the youths are skateboarding, roller skating, rock climbing and bike riding (Kahiruddin et al., 2015). Hence, a park with specific themes such as skatepark, outdoor wall climbing, Parkour Park and street art park are some of the examples of play spaces anticipated by Gen Z youths.

On the other hand, there are various issues relating to recreational parks usage and some are associated with youths' unhealthy social activities. Reported cases include loitering, illegal racing, vandalism and graffiti. One of the main factors that contribute to the social issues are lack of appropriate open spaces compatible to youth's needs (Kahiruddin et al., 2015). The issues relate to the

provision of recreational parks and conducive parks' designs for youths' activities.

## **MATERIALS AND METHOD**

### **Unit of Analysis**

The respondents consist of Gen Z youth who live in Kuala Lumpur. The total population of Gen Z in Kuala Lumpur is 115, 600 (Department of Statistic Malaysia, 2016), and based on this number, the minimum sample size required for this study is 383. The survey obtained a total of 564 respondents within the age of 15 to 21 years old. The sample size is considered sufficient.

### **Research Instrument**

A self-administered survey questionnaire serves as the primary data for this research. The survey covers parameters that include leisure time needs of Gen Z and their activities in the recreational park. The questionnaire was designed with a combination of open-ended and closed-ended questions. The questions consist of dichotomous scale, categorical scale and a positive five-point Likert format (response from 5-strongly agree with 1-strongly disagree and a 3-neutral option). The questionnaire form consists of five sections including respondents' demographic profile, leisure time activities, outdoor public spaces, activities in recreation parks and health status. The survey items were derived from the dimensions established by a literature research especially the articles from 2008 until the current ones because the first generation of Gen Z youth emerged in 2008 at the age of 15.

### **Methods of Data Collection**

The sampling method was convenient sampling, which was carried out in two ways. First, the researchers distributed the survey forms to the passers-by in the recreational park. Self-administered questionnaire surveys were conducted at several recreational parks located in six strategic zones of Kuala Lumpur city. They are the areas of Kuala Lumpur City Center (zone A), Wangsa Maju-Maluri (zone B), Sentul-Manjalara (zone C), Damansara-Penchala (zone D), Bukit Jalil-Seputeh (zone E) and Bandar Tun Razak-Sungai Besi (zone F). 13 recreational parks were selected as these parks tend to be visited by nearby residents. The researchers also distributed survey forms to youths in their residential areas. The respondents were selected within the radius of 1 to 3 kilometers from the recreational parks.

### Analysis

IBM SPSS Statistics version 23 was used to run the analysis. Descriptive analysis using percentage and mean was performed to present a demographic profile, the use of recreational park by Gen Z, their perceptions, as well as their needs. The descriptives were helpful in summarizing the sample.

### FINDINGS

The findings discussed here are based on analyses of parameters, which include the respondents' characteristics as well as use, perception and needs of Gen Z towards recreational parks of Kuala Lumpur.

#### Characteristic of Respondents

Four socio-demographic parameters of the study are: area of residency, education level and occupation as shown in Figure 1.

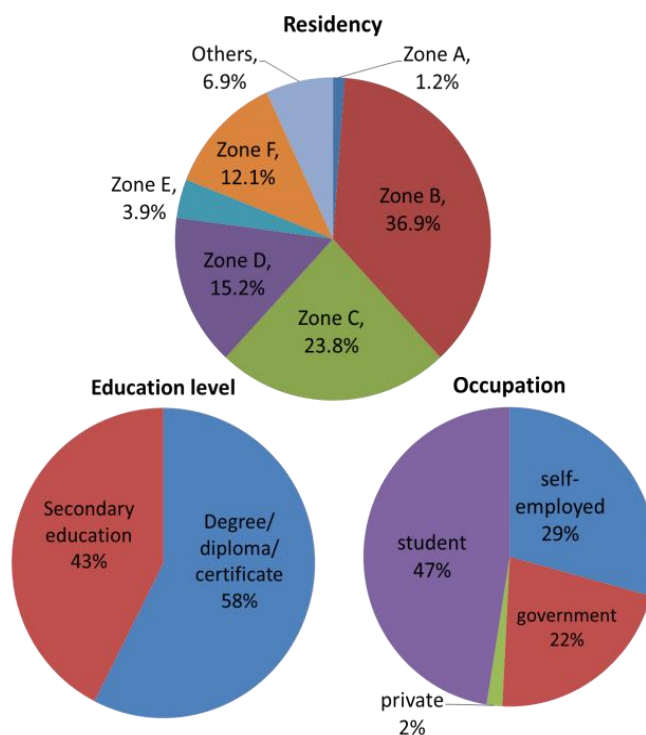


Figure 1: Characteristics of the respondents.

The Gen Z respondents were within the age of 15 to 21 years old (n = 540). Most of them live in Wangsa Maju, Maluri (Zone B) (36.9%), followed by

Sentul, Manjalara (Zone C) (23.8%), Damansara, Penchala (Zone D) (15.2%), Bandar Tun Razak, Sungai Besi (Zone F) (12.1%), Bukit Jalil, Septih (Zone E) (3.9%) and Kuala Lumpur City Centre (Zone A) (1.2%). ‘Others’ (6.9%) represent the respondents who live in the fringe of Kuala Lumpur, such as Putrajaya, Shah Alam and Petaling Jaya. Most of the Gen Z were approached in well-known recreational parks, other than residential areas around the park. For examples, Titiwangsa Lake Garden in Wangsa Maju, Maluri zone and Kepong Metropolitan Park in Sentul, Manjalara zone.

Half of the respondents were degree, diploma and certificate holders (57.5%), and another half of respondents finished their secondary education (42.5%). The majority of respondents were students (93.4%). The rest were either employed in the government sector (1.2%), private sector (3.4%) or self-employed (2.0%). Hence, most of the respondents are among university and high school students.

### Types of Recreational Parks Visited

For this parameter, closed-ended questions in Likert scale format were analyzed. Table 1 shows the percentage on frequency of visit with format: (1) never and (2) love (very seldom) = twice or more a year. Moderate to high scales consist of measures (3) seldom = once a month, (4) sometimes = twice a month, (5) often = once a week and (6) very often = twice or more a week.

**Table 1:** Frequency of visit to recreational parks in Kuala Lumpur by Gen Z youth.

Park/Measure	Never	Low	Moderate to high			
	1	2	3	4	5	6
<b>City / Metropolitan Park</b>						
a. Perdana Botanical	60.1	22.2	9.4	5.1	2.1	1.1
			17.7%			
b. Lembah Kiara Park	70.4	17.7	6.7	3.2	0.7	1.2
			11.8%			
c. KLCC Park	22.5	39.5	16.3	15.8	3.5	2.3
			<b>37.9%</b>			
<b>District Park</b>						
a. Bukit Gasing Park	73.4	14.7	5.7	4.4	0.9	0.9
			11.9%			
b. Titiwangsa Lake Garden	27.5	32.4	15.8	14.2	6.2	3.9
			<b>40.1%</b>			
c. Bukit Jalil Int. Park	67.6	16.5	7.3	5.1	2.1	1.4
			15.9%			
d. Permaisuri Lake Garden	64.0	14.0	8.2	6.7	4.1	3.0
			22%			
e. Kepong Metropolitan	58.5	15.4	9.0	8.2	6.4	2.5
			26.1%			



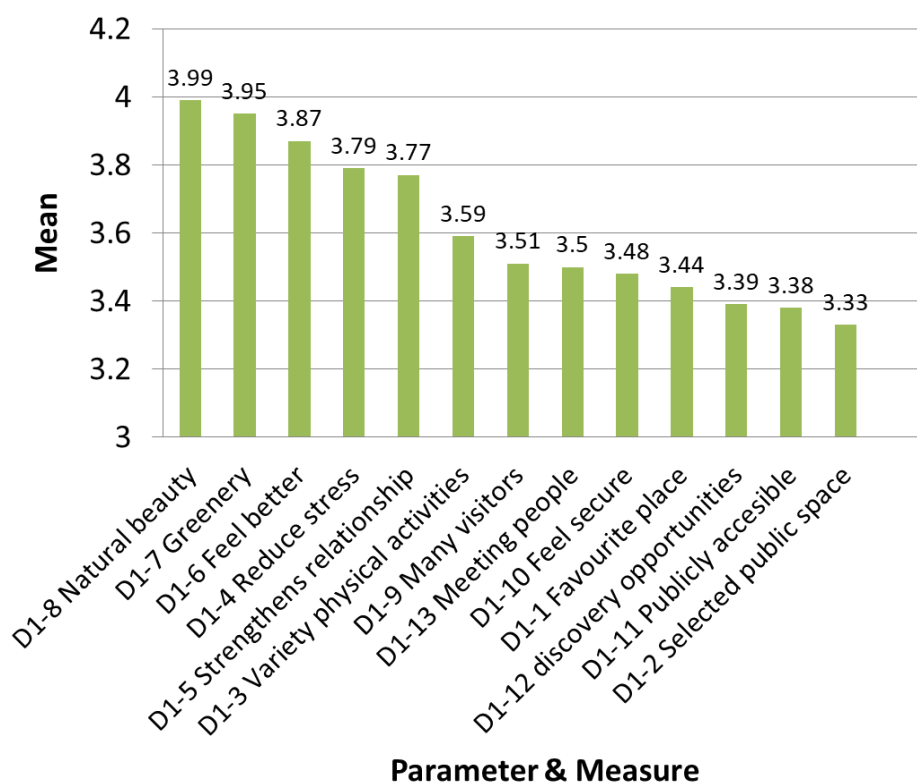
f. Batu Metropolitan	74.8	10.8	4.6	3.7	2.5	3.5
		14.3%				
g. Danau Lumayan Park	84.6	7.4	3.9	2.1	1.2	0.7
		7.9%				
h. Pudu Ulu Lake Park	84.2	8.5	2.7	3.4	0.5	0.7
		7.3%				
i. Taman Wahyu Lake	83.9	8.0	3.4	3.0	1.1	0.7
		8.2%				
j. Alam Sutera Park	84.2	8.7	2.7	2.7	1.2	0.5
		7.1%				

Based on moderate to high percentage on visit, result suggests that the highest visitation is to Titiwangsa Lake Garden (40.1%) and KLCC Park (37.9%). Both recreational parks were well-known city parks in Kuala Lumpur. These parks were famous for their many programmes, events and activities for youth, as compared to other recreational parks in the city. They were also easily accessible because of variety of options for public transport such as LRT and buses.

Additionally, Gen Z frequently visits Kepong Metropolitan Park (26.1%) in Sentul–Manjalara zone and Permaisuri Lake Garden (22%) in Bandar Tun Razak–Sungai Besi zone. These recreational parks were the main neighborhood parks, surrounded by residential houses. Park users were living within 1 to 3 km from the main recreational parks. For Perdana Botanical Garden, despite being a city park, the park provided less space for youth activities. The park was more focused on tourist attractions, hence merely 17.7% of youths visited the park. Other parks such as Danau Lumayan Park, Pudu Ulu Lake Park and Alam Sutera Recreation Park received low percentage of visits. Gen Z was not familiar with the mentioned parks. Among the reasons that the respondents never visited the parks were transportation issues and unfamiliarity with the smaller scale parks. Limitations of the study include the bias sizes of samples from zones Wangsa Maju-Maluri (36.9%) and Sentul-Manjalara (23.8%).

### **Reasons for Visiting Recreational Parks**

Figure 2 shows the mean of thirteen items on Likert scale format (1=strongly disagree; 5 strongly agree). The items relate with reasons of going to recreational parks in Kuala Lumpur. All items' mean score were greater than 3 (neutral), which indicate positive responses.



**Figure 2:** Reasons for visiting recreational park

The most agreed reasons for going to parks were: recreational parks offer nature experience (mean=3.95-3.99), provide emotional relieve (feeling better=3.8; relax and reduce stress=3.79), social benefits (3.77) and provision of activities (3.59). The result implied that recreational parks in Kuala Lumpur were visited due to the natural attributes, to improve emotional well-being and for socializing through various outdoor activities.

### Needs of Gen Z in Recreational Park

The needs of Gen Z of leisure time activities in recreational park were also investigated. The measures for youths' activities in recreational park were derived from the literature review obtained through international and local papers that covers from 2008 up until the current ones. Twelve measures on activities were analyzed and categorized into three parameters. They were: (a) active activities, (b) recreational activities and (c) extreme activities (Figure 3).

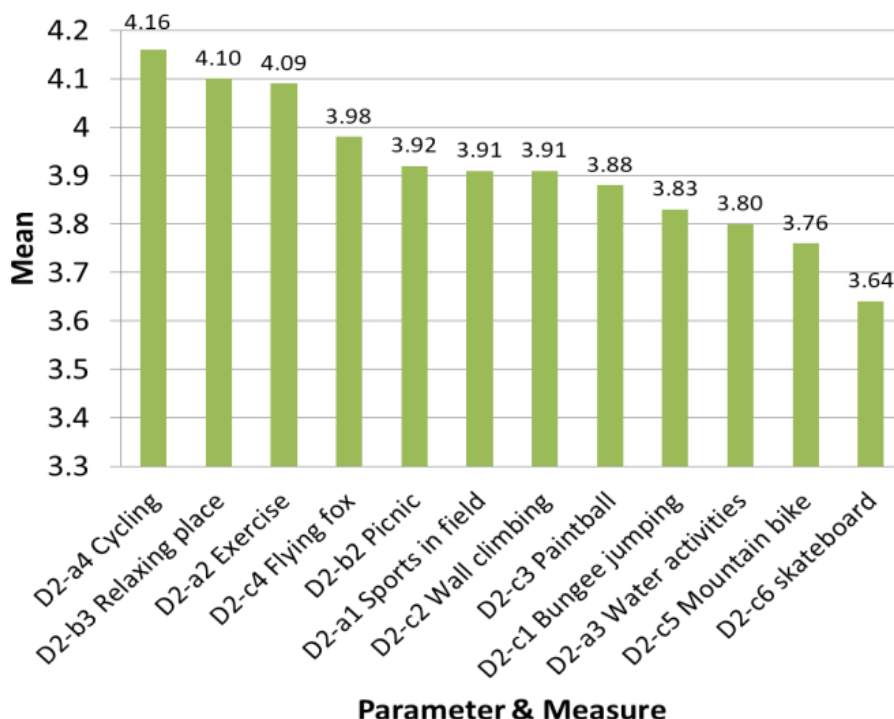


Figure 3: Needs for recreational parks (Likert scale).

Based on mean result, the majority of respondents agreed that cycling, relaxation and exercise were the top activities that they need (mean>4.00). The results showed that the function of recreational park for Gen Z was similar to the previous generation of youth, which was the for leisure activities that offer nature, calmness and healthy environment. Gen Z would like parks to offer extreme activities such as flying fox (mean=3.98), wall climbing, bungee jumping, mountain bike and skateboard (mean=3.64 – 3.91). The results suggest that Gen Z agreed that recreational parks should offer extreme activities, which they consider necessary to attract youths. However, not all recreational parks can offer extreme activities. Extreme activities differ from active and other recreational activities, which may not be suitable for all types of recreational park. This is because it depends on the topography, functions and design intention of the parks. Even though the lifestyles of youths are changing, their primary needs of the outdoor activities still lean towards active and extreme activities, as findings and literature review suggested. Therefore, recreational parks should be up to date in design and should offer variety of activities for Gen Z youth to express their identity as youths.

An open-ended question was included in the questionnaire that asked about youths' needs of parks in Kuala Lumpur. The question was posed to expand to complement the closed-ended question on the item. Their answers were analysed and categorized using related keywords. 28 answers were recorded from 15 respondents. The parameters emerged were summarized and categorized into five: (i) extreme activities (39%), (ii) traditional games (25%), (iii) organization programs (18%), (iv) Islamic recreation and sports (11%) and (v) art and entertainment (7%).

The responses revealed that currently extreme activities were increasingly in demand among Gen Z youth. Nonetheless, they also mentioned that traditional games in recreational park such as *teng teng*, *galah panjang*, *congkak*, *sepak takraw*, and others should also be introduced or maintained. The traditional games in a recreational park were alternative playtime activities in parks to preserve heritage and culture of people to the youth. The respondents also suggest that authorities and organizers need to offer more events or social programs in recreational parks. For examples, fitness programs (*zumba*, *aerobic*), exhibition and marathon. These events and programs acted as key attractions for some outdoor activities. Respondents also suggested that promotion on activities that were related with religious sports and recreation such as archery, horse riding and street *dakwah* and *usrah* should be conducted and could increase positive attitude among youths in their social activity. In terms of art and entertainment, the respondents prefer to have activities like busking and painting. These activities would make the recreational parks appear more exciting and invigorating for the youths.

## CONCLUSION

Overall, the study found that Gen Z youth in Kuala Lumpur significantly used the recreational parks for their leisure time activities. Most of them prefer recreational park more than other public spaces because of the naturalness of the environment. The parks make them feel physically and mentally healthy. Gen Z youth also tend to spend their time in recreational park if they were near to their living area, provide favourable facilities and offer variety of events, programs and activities. The study suggests that recreational parks should also focus on design aspects for the youths such as types of activities ideal for their physical movement and recreation. Their needs of activities that are trending such as extreme sports urge improvement in provision of facilities specifically designed for youths. At the same time, their propositions on traditional games and Islamic sports suggest that the youths value heritage, culture and religious teachings. The criteria of outdoor space for youth activities meet the current needs of Gen Z youths. Parks should introduce spaces and activities that excite and promote positive socialization among all groups of users.

## **ACKNOWLEDGEMENT**

This paper was supported by grant by MOHE under Grant Nos. FRGS 15-258-0499.

## **REFERENCES**

- Abd-latif, R., Nor, M. M., & Omar-Fauzee, M. S. (2011). Influence of recreational facilities among adolescents towards leisure time physical activity (LTPA). *Asian Journal of Environment-Behaviour Studies*, 2(5), 37-46.
- Aminuddin, Y., Abdullah, M. N. H., Fauzee, M. S. O., Soh, K. G., Ismail, I. A., Abdullah, A. L., & Adam, Y. (2009). *Kajian penglibatan golongan belia dan masyarakat dalam sukan*. Laporan akhir akademi Sukan, Universiti Putra Malaysia.
- Biddle, S. J. H., Marshall, S. J., Gorely, T., & Cameron, N. (2009). Temporal and environmental patterns of sedentary and active behaviors during adolescents' leisure time. *International Journal of Behavioral Medicine*, 16(3), 278-286.
- Danis, A., Sidek, S., & Yusof, S. M. (2014). Environmental characteristics influences on physical activity among overweight adolescents: Urban neighbourhood parks. *Procedia - Social and Behavioral Sciences*, 153, 402-409.
- Department of Statistics Malaysia (2016). *Population quick info*. Retrieved March 1, 2017, from <http://pqi.stats.gov.my/result.php?token=bd7af7492d376bb6287f4523fbca8b5e>
- Khairuddin, S. A., Mohd Yunos, M. Y., Mydin, M. A. O., & Ujang, N. (2015). Youth preference of extreme parks design in urban areas. *Advance in Environmental Biology*, 9(4), 197-200.
- Lim, K. C., Mat Yusof, M., Fauzee, M. S. O., Othman, A. T., Aman, M. S., Gunathevan Elumalai, & Mohd Ali, H. (2016). Examining sport and physical activity participation, motivations and barriers among young Malaysians. *Asian Social Science*, 12(1), 159-171.
- Latifiyan, M., & Salavati, M. (2015). Environment designing considering the needs of youth according to Abraham Maslow's needs case study. *African Journal of Business Management*, 9(1), 8-17.
- Makinen, K., & Tyrvaainen L. (2008). Teenage experiences of public green spaces in suburban Helsinki. *Urban Forestry and Urban Greening*, 7, 277-289.
- McCrinkle, M., & Wolfinger, E. (2008). *The ABC of XYZ: Understanding the global generations*. Sydney, Australia: University of New South Wales Press.
- Ngesan, M. R., Karim, H. A., Zubir, S. S., & Ahmad, P. (2013). Urban community perception on nighttime leisure activities in improving public park design. *Procedia - Social and Behavioral Sciences*, 105, 619-631.
- Rabe, N. S., Osman, M. M., & Abdullah, M. F. (2017). Assessment on public perception towards the development of 1Malaysia youth cities. *Advanced Science Letters*, 23(7), 6102-6105.

- Poh, B. K., Safiah, M. Y., Tahir, A., Siti Haslinda, M. D., & Siti Norazlin, N. (2010). Physical activity patterns and energy expenditure of Malaysian adults: Findings from the Malaysian adult nutrition survey. *Malaysian Journal of Nutrition*, 16(1), 13-37.
- Rideout, V. J., Foehr, U. G., & Roberts, D. F. (2010). *Generation of M2 media in the lives of 8-18 years olds*. Washington D. C.: Henry J. Kaiser Family Foundation.
- Sladek, S. & Grabinger, A. (2014). *Gen Z: The first generation of the 21st Century has arrived!* Retrieved May 5, 2016, from [http://xyzuniversity.com/wp-content/uploads/2014/02/GenZ\\_Final.pdf](http://xyzuniversity.com/wp-content/uploads/2014/02/GenZ_Final.pdf)
- Wilson, N. C. (2006). *Preliminary study of the physical activity participation patterns of Malaysian youth*. Kuala Lumpur: Majlis Sukan Negara Malaysia.
- Zulkia, D. R., Zainol, R., Zainol, N., & Nordin, N. A. (2014). Factors determining youth's recreational behaviour and its effects on body mass index (BMI). *Journal of Surveying, Construction and Property*, 5(2), 1-11.



## **HISTORICAL URBAN FORM: A CASE STUDY OF MELAKA**

**Illyani Ibrahim<sup>1</sup>, Alias Abdullah<sup>2</sup>, Mansor Ibrahim<sup>3</sup>, & Fatin Farhana Murtaza<sup>4</sup>**

<sup>1,2,3,4</sup>*Kulliyyah of Architecture and Environmental Design,*  
INTERNATIONAL ISLAMIC UNIVERSITY MALAYSIA

### **Abstract**

Understanding the urban form is crucial in determining the structure of a city in terms of physical and nonphysical aspects. The physical aspects include built-up areas that can be seen on the earth surface, and the nonphysical aspects include the shape, size, density, and configuration of settlements. The objectives of this study are to (i) analyse the elements of historical urban form that are suitable for the site and (ii) to study on the elements of urban form in Melaka. Content analysis was adopted to analyse the literature of urban form and Melaka. Results show that the following four elements of urban form are suitable to be used for historical urban form analysis: (i) streets, (ii) land use, (iii) buildings, and (iv) open space. The findings also indicate that the selected urban form has successfully delineated in the historical of Melaka as the selected urban elements can be specifically scrutinized with the content analysis. Further study will focus on the historical urban form within the Malay Peninsula.

**Keyword:** urban form, historical built environment, Melaka

<sup>1</sup>Assistant Professor at International Islamic University Malaysia. Email: illyani\_i@iium.edu.my

## INTRODUCTION

In certain historical period, historical urban areas took the form of various landscapes. UNESCO defines a historic urban landscape as “*an urban area understood as a result of a historic layering of cultural and natural values and attributes, extending beyond the notion of historic centre or ensemble to include the broader urban context and setting.*” Urban form is defined as the physical characteristic on the earth surface with a combination of built-up areas that can extend various scales, namely block, street, neighbourhood, urban, and regional. Urban form has also been defined as a “*settlement form as a spatial arrangement of physical environment, the resulting spatial flows of persons, goods and information, and the physical features which modify spaces*” (Lynch, 1984). This definition implies that an urban form does not merely constitute the physical aspects of a city but also the changes of its forms.

Spaces and objects that are related to a historic built environment (HBE) play a significant role in providing many of the attributes necessary for pleasing an urban form (Lynch, 1960). Space refers to build and unbuilt elements that exist on the ground surface, and urban form is the collective ensemble of these spaces (Newman, 2016). Space typologies are multiple and can include plazas, squares, streets, avenues, alleys, structures and many others.

However, after more than hundreds of years, many elements of HBE are removed or destroyed hence the urban forms proved difficult to preserve. An urban form evolves constantly in response to several factors, such as social, environmental, economic, and technological developments; planning, housing and urban policies; and health, transport, and economic policies. Nevertheless, these typologies are the micro elements that need to be defined.

While the past is mostly unreachable, every detail of its life (and all other events) remains recorded in the matrix of space and time, and all are capable of some kind of review (Brush, Fabos, & Zube 1975). Past events are not always tangible, but they are important nonetheless. Therefore, reviewing the literature of historical books and *hikayat*, to list a few, is important in order to understand past events that may be related to historical urban form.

**Table 1:** Literature on the elements of urban form

<b>Author</b>	<b>Elements</b>
Relph (2014) & Kostov (2004)	Plan of streets and property boundaries, land use, the urban fabric of buildings and materials
Lynch (1984)	Path, edges, districts, nodes and landmarks
Scargil (1979)	Buildings and skylines
Krier (1979)	Squares (buildings) and streets
Valente-Pereira (1982)	Landscape/soil, outdoor spaces, buildings
Morris (1994)	Walls, streets, markets, churches



Heryanto (2001)	Building form, street pattern, land use, open space, skyline.
Anderson et al. (1996)	Type of urban settlement (market town, central business district or suburbs)
Williams et al. (2000)	Building materials, facades and fenestration, housing type, street type and their spatial arrangement / layout
Dempsey et al. (2008)	Size, shapes, scale, density, landuses, building types, urban block layout, distribution of green spaces

This paper is organized as follows. Section 2 provides related examples of a historical of urban form. In section 3, method is discussed. In further, section 4 is discussing on the analysis of urban form. Section 5 on the empirical case study of Melaka is presented. The analysis and findings in this paper are presented in section 6 and the final section concludes the discovery.

### **HISTORICAL URBAN FORM**

The section will focus on the cities built between 1200 CE and 1900 CE. This timeline was selected as the timeline of the case study is in Melaka was also between the same timeline.

Many of the cities in China are located at the low land; in floodplain, river valleys, intermountain basins, and small oases along the foothills (Chang, n.d.). Those city walls were built to protect palaces, temples, residences and administrative area. The road leading from the bridge to the gate was seldom straight. Many traditional areas are also devoted as a cultivation and water bodies as a recreational areas.

In Lahore, India, a walled city of Lahore, the old historic core is built on elevated ground with a mosque as focal point, surrounded by Bazaars, Badshahi Mosque Greater, while the spatial distribution of bazaar is following a linear clusters along the primary streets, and the residential area was built on privacy principles, courtyards oriented with a 2-3 stories (Gulzar, 2017).

The historical view of Toronto (Relph, 2014) begins in the centre and the fields became more numerous than houses. Built in 1792, Toronto's streets and lot patterns were simply laid out as smaller rectangles within the master grid of concession roads.

In 1869 in the residential suburbs in Illinois, the streets were curvelly planted and the houses were set back from the streets. A park was located along the river and pocket parks were seen at the road junctions.

In Italy, the wall of Siena divided the well-governed city of Tuscany into several countryside areas (Kostov, 2004). Access to town and market was controlled at the city gate, where not all of the people able to shop inside the city. The painting of Tuscany in 1340 by Palazzo Pubblico shows a tight-packed houses and shops with a busy workers, while in the countryside area, people work

in the field, the paved high road, and the fortified villa-farm on the hill (Kostov, 2004).

In the case Novgorod, Russia, the same author (Kostov, 2004) mentions that in 1635, on the side of the Volkhov River was a brick-walled kremlin and a fortress that located the cathedral and administrative headquarters. Opposite the river was a wooden-walled market crammed with merchants' homes, warehouses, and churches founded by individuals or local communities. Many towns built at the river bank have given a character to a city form. The settlements in some of the cities were arranged following the river; some of the settlements were mixed developments with shops at the lower floor and residential facilities at the upper floor.

In 1873, the old dense city of Vienna was located at the city centre with a monument. Several elements in the city provided a protective zone between classes, namely the suburb areas, major civic and national administrative buildings, cultural institutions, and a few elegant residential blocks that were interspersed with public gardens (Kostov, 2004).

However, Mecca in 1884 was a town with traditional low-rise structures and a courtyard-housing Islamic city. The city located many three-storey houses with windows overlooking the streets. Another evidence by al-Muqaddasi (by referring to Burckhardt (1829) in (Morris, 1994) mentions that the houses of Mecca were built in black, smooth, and white stones with a brick at the upper part of it. Narrow streets also served to cool the air. A musolla became an open space for public for both mosques in Mecca and Medina. In addition, the streets were the public space, and a pocket space and courtyard can be found in residential houses.

The mosque of Medina was situated at the eastern side of the town, and it was built entirely of stone. The houses were generally two-storeys with flat roofs. A few of the principal streets were paved with large blocks of stone and the markets were located at the left and right side of the streets. The gardens, dates and wheat plantations, as well as barley fields surrounding the suburbs are explained by Burckhardt (Morris, 1994).

## **METHODOLOGY**

This research focuses on Melaka due to the abundant information (maps and literature) available on this historical city. Firstly, elements of urban form was analysed for the use of presenting the historical urban form. Secondly, content analysis was performed to analyse the city form of the study area using the selected urban form elements. Any related information on the physical structures of the city was used to analyse the city's urban form.

### ANALYSIS ON THE USE OF URBAN FORM

The uses of the urban form were analysed by examining relevant theories of urban form as employed in previous studies (Table 2). This analysis will answer the first objective, which is to analyse the elements of historical urban form that are suitable for the site.

**Table 2:** The use of urban form and the authors

Elements of Urban Form	Authors
Streets/path	Relph (2014); Lynch (1984); Krier (1979); Heryanto (2001); Williams et al. (2000)
Edge	Lynch (1984)
Districts	Lynch (1984)
Nodes	Lynch (1984)
Buildings/landmarks	Relph (2014); Lynch (1984); Scargill (1979); Krier (1979); Valente-Prier (1982); Heryanto (2001); Williams et al. (2000)
Materials	Relph (2014);
Open space	Valente-Pereira (1982); Heryanto (2001); Williams et al. (2000)
Skylines	Scargill (1979); Heryanto (2001)
Landscape/soil	Valente-Pereira (1982)
Walls	Morris (1994)
Market	Morris (1994)
Churches	Morris (1994)
Landuse	Lynch (1984); Heryanto (2001); Morris (1994); Anderson et al. (1996); Williams et al. (2000)
Size, shapes, scale, density	Williams et al. (2000)

According to the analysis shown Table 2, this study used four elements of urban form: streets, buildings, open space, and land use. Building form is important to quantitatively describe the character of a town that has become a landmark to a city (Lynch, 1960). The main purpose of a building is to fulfil the human activities such as living, working, and entertaining (Heryanto, 2001). Streets is also an important element in urban form, particularly as main transportation for people to move from one node to another. There are several types of streets, for example, linear, grid structure. Land use use is important to make the land manageable and fully utilised. The land should be divided according to different purposes: residential, commercial or agriculture. The last element is open space, consists of the public open space, places for the public to stay for a while, and more specific materials, namely the walking surface of footpaths and the city's furniture such as walls, benches, and bus stops. The author decided not to include skyline as there were very limited skyline of the physical structure of the historical cities in Asian. These elements also suitable to be used

as it is a low resolution, as currently those physical elements are not there and difficult to measure using the good resolution. The good level of resolution will show a better details.

The analysis was arranged according the events' during the reign of Sultan Mahmud Shah. As no direct analysis on the urban form was written in the books, thus the extraction of the urban form from the literature review was appropriate for this study. Thus, based on the discussion of the physical structure of the urban form, four major elements that have shaped the urban form are building, street pattern, land use pattern, and open space. Therefore, the analysis of urban form for Melaka historical city will be tested and guided based on these elements. Further section will answer the second objective that is to study on the elements of urban form for Melaka area.

### **ANALYSIS DURING THE REIGN OF MELAKA SULTANATE**

Melaka was founded by Parameswara who fled Palembang and Temasek in 1400. He embraced Islam since 1414 and had his name changed to Megat Iskandar Shah. He managed to change Melaka to a bustling entrepot in Asia and spreaded Islam in this region. Merchants from Arabia, Persia, India, China, the Malay Archipelago, and even such distants corners of the world such as Portugal and Japan could be found in the marketplace of Malay Melaka (Lewis, 1995). However, Melaka was captured by Portuguese in 1511 for 130 years, then by Dutch in 1641, and in the year of 1826, was took over by British.

The historical Melaka city was located near the river. It was still preserving the nature of sloping and hilly areas as a place for agriculture. This characteristics indicate that the old city conformed to the natural landscape despite the development of early technologies. This old city were located next to the river because it was easy to obtain water supply and because transportation from out of the cities were mostly from oceans across to the river. The rivers served not only as an instrumental and economic value for transporting goods and people, but also a key component of the urban landscape.

This city served as centers of administration and defence. The palace of Parameswara was located on the hilltop on the Melaka Hill (previously St. Paul's hill) and close to the port. Zheng He also mentions about the structure of the sharp wood surrounding to the palace (fort) which functioned as fences. There was also a grand entrance where a tower was placed (Kong, 2000).

There are several sketches done by the Portuguese that can be referred in order to study the urban form. Figure 1 shows a number of vessels of Portuguese during the visit to Melaka. Many tall and big building structures along the coastal area were seen from the vessel.



**Figure 1:** Melaka view from the Portuguese in 1509 before the attack  
*Source: Van Der Aa (1706)*

Figure 2 (below) shows a sketch of Melaka port view from the sea on the Portuguese ship. A buildings of two and three floors, a dome and minarets of the mosque were seen. The mosque and palace are made by stone as a strong materials and there also a smaller buildings also made by stone located nearby the mosque (Correia, 1858). These sketches represents.



**Figure 2:** A close-up view of Melaka  
*Source: Van Der Aa (1706)*

As narrated by Tome Pires (Noor, 2013), the mosque known as Masjid Jamik Melaka was located close to the palace. Connected by a bridge, the mosque and palace were very close, and the bridge served to perform the prayer in the mosque (Noor, 2013). However, the mosque was demolished from fire and the site was later rebuilt with A Famosa.

The settlements were found to be concentrated on the riverside and in front of the sea. There are many beautiful stone and wooden houses. Those settlements in the agriculture areas were found to be dispersed. During Zheng He's visit in 1414, he added that the houses were like rooftop houses about four yards high, on which there was no board. There was roof sago palm leaf tied with rattan rope. Many shops for the trade activities operated on the bridge crossing the river.

Figure 3 shows a part of Melaka Fort sketched by Portuguese in 1509 during the visit of Lopez De Sequeira as a representative of Portuguese. The sketch was directed to the sea and a structure like a brick wall, gates and part of the building inside the wall was seen. Elephants used as a transportation modes on the land and ships or boats used on the sea or river.



**Figure 3:** A part of Melaka fort in 1509  
*Source: Van Der Aa (1706)*

It was further elaborated that a market was located at the beach at the mouth of the river (de Eredia, 1930). During Sultan Mahmud's reign, Melaka secured tax revenue from street sellers (Pires, 1944). Merchants from Jawa had been selling a variety of rice and edible grain in the market, and monancabos from Sumatera had been sending stocks by boats to market in Melaka. The stocks were transferred with sampans or cargo boats. Shops are also located in front of the houses (Pires, 1944).

It was also recorded that many main streets in the city leading to the bridge (de Barros, n.d.) and leading to the coastal area (Correia, 1858). Other record written in the Malay Annals, that there is a four-junction road located in the middle of the city (Tun Sri Lanang, n.d.). A planned road network and well-arranged and bridges built in Melaka city to connect the land roads that separated by the river (Yusof, 2017).

Farming was another routine of the dwellers in Melaka. The law of Melaka or *Undang-undang Melaka* dictates that farms need to be well maintained and fenced by the owner. The natives dwelled in their orchards and gardens along the banks of Melaka River. They had been raising large herds of cattle and animals such as geese, ducks, and fowls (de Eredia, 1930). An account (Pinto, 2011) notes that up to 8 to 10 miles (12 to 16 km) in the suburbs area were mostly covered with large orchards, beautiful meadows, or pastures for livestock and rice fields under cultivation. These statements indicate that agriculture activities also took place in the suburban areas.

Table 3 show the analysis elements of urban form based on the event analysis. The analysis of Melaka events show that the construction of fort was essential as an administration and defence centre. The palace was important for the residential of Sultanate; it existed before the attack of Portuguese. The market was located nearby the beach so the stocks from other areas can be easily transferred. In terms of land use, there were farms, orchard, and gardens which acted as agricultural areas, and the transportation areas were linear street pattern with a mixed use of residential and commercial areas.

**Table 3:** Urban form elements and the characteristic of Melaka City during the Melaka Sultanate

Urban Form	Characteristics of the Area
Streets	Linear streets, playing a role to differentiate land cover Streets divided into two modes; road and river Melaka river as an important transportation
Land Use	Clustered settlements in the coastal area and dispersed in the agricultural area Gardens, orchards, and farms among the land use types Market on the bridge, along the streets and nearby the beach
Buildings	Walled palace Port near the river opposite to administration area Fort surrounding palace Mosque close to the palace
Open space	Orchard and graveyards close to the river

In terms of land cover, most of the areas were distributed according to their land use. Only seven land cover areas can be identified: administrative area, mosque, shops, settlement, rivers and streets, agricultural area, and graveyards. Rivers and streets were the main important features that served as transportations areas.

In the historical Malay world, the river played an important role; it was also the main transportation for the community to move from one side of the river to another. The main transportation during those days was river transportation. Thus, the subject is to identify the rivers as a street, whereby the waterways were

still an important transportation in Venice and Dutch cities, whose canal streets played a distinctive and gracious role (Kostov, 2004). In Melaka, the palace was walled with an imported grave tomb, indicating a high rank and power of those living in it (Lynch & Rodwin, 1958). In addition, the city of Melaka was located on the hilltop and close to the river, a view that contradicts that of Alattas (1997) who claims that the Southeast Asian riverine city was located on hilltops.

## **CONCLUSION**

This research confirms that the use of the four urban form elements are appropriate for analysing historical urban form. Future studies might consider using these urban form elements to analyse the historical urban form for the whole Malay Peninsula.

## **ACKNOWLEDGEMENT**

This work was supported in part of Transdisciplinary Research Grant Scheme (TRGS) No. TRGS/1/2016/UIAM/01/5/1.

## **REFERENCES**

- Alatas, S. M. (1997). *Cultural symbolism and legitimization in the context of change : Early Malay state formation*. Colombia University.
- Anderson, W. P., Kanargoglou, P. S., & Miller, E. (1996). Urban form, energy and the environment. *Urban Studies*, 33, 17-35.
- Brush, R. O., Fabos, J. G., & Zube, E. H. (1975). *Landscape assessment: Values, perceptions, and resources*. Stroudsburg, PA: Dowden, Hutchinson & Ross.
- Chang, S. (n.d.). *The morphology of walled capitals*. S.l.: S.n.
- Correia, G. (1858). *Lendas da India*. Lisboa: Typ. da Academia real das ciencias.
- de Barros, J. (n.d.). *On the deeds & discoveries & conquests made by Portuguese in the seas and Eastern Lands*. Divisao de Publicacao e Biblioteca Agencia Geral das Colonias Lisboa.
- de Eredia, E. G. (1930). *Eredia's Description of Malacca*. KMBRAS.
- Dempsey, N., Brown, C., Raman, S., Porta, S., Jenks, M., Jones, C.,... & Urban, E. (2008). *Sustainable city form* (Vol. 2).
- Gulzar, S. (2017). Walled city of Lahore: An analytical study of Islamic cities of Indian subcontinent. *International Journal of Research in Chemical, Metallurgical and Civil Engineering*, 4(1), 69-73.
- Heryanto, B. (2001). *The spirit and image of the city: A case study of the changing and developing urban form of Ujung Pandang, Indonesia* (Doctoral dissertation). Virginia Commonwealth University, 2001.
- Kong, Y. (2000). *Pelayaran Zheng He dan alam Melayu*. Bangi: Penerbit Universiti Kebangsaan Malaysia



- Kostov, S. (2004). *The city assembled: The elements of urban form through history*. New York: Thames & Hudson.
- Krier, R. (1979). *Urban space (Stadtraum)*. New York: Rizzoli.
- Lewis, D. (1995). Jan Compagnie in the Straits of Malacca 1641 - 1795. *Monographs in International Studies Southeast Asia Series*, No 96.
- Lynch, K. (1984). *A theory of good city form*. Cambridge, MA: MIT Press.
- Lynch, K. (1960). *The image of the city*. Cambridge, MA: MIT Press
- Lynch, K. & Rodwin, L. (1958). A theory of urban form. *Journal of the American Institute of Planners*, 24(4), 201-214.
- Morris, A. E. (1994). *History of urban form before the industrial revolutions*. Harlow: Longman.
- Newman, G. D. (2016). The eidos of urban form: A framework for heritage-based place making. *Journal of Urbanism: International Research on Placemaking and Urban Sustainability*, 9(4), 388-407.
- Noor, S. Z. S. M. (2013). *Pentadbiran Kesultanan Melayu Melaka: Kemunculan dan kegemilangan*. Kuala Lumpur: Arkib Negara Malaysia.
- Pinto, P. J. S. (2011). *Os casados de Malaca, 1511-1641: estratégias de adaptação e de sobrevivência*.
- Pires, T. (1944). *The suma oriental of Tomé Pires: An account of the east, from the Red Sea to Japan, written in Malacca and India in 1512-1515, and the Book of Francisco Rodrigues, rutter of a voyage in the Red Sea, nautical rules, almanac and maps, written and drawn in the East before 1515* (Vol. 1). London: Hakluyt Society.
- Relph, E. (2014). *The urban form of Toronto*.
- Scargill, D. I. (1979). *The form of cities*. London: Bell & Hyman.
- Tun Sri Lanang (n.d.) *Malay Annals*.
- Valente-Pereira, L. (1982). Definição da Forma Urbana no Planeamento Físico Urbanístico.
- Van der Aa, P. (1659). *Leiden 1659 - 1733*.
- Williams, K., Burton, E., & Jenks, M. (2000). *Achieving sustainable urban form*. London: E & FN Spon.
- Yusof, H. (2017). *Teknologi kesultanan Melaka: Membongkar keagungannya berdasarkan catatan Portugis*. Negeri Sembilan Darul Khusus: Cintai Publication.



## **IN PURSUIT OF ECONOMICALLY COMPETITIVE AGRO-TOURISM SECTOR: THE CASE OF TERENGGANU HOMESTAY, MALAYSIA**

**Syahriah Bachok<sup>1</sup>, Tuan Anisdina Tuan Mohd Amin<sup>2</sup> & Syakir Amir Ab  
Rahman<sup>3</sup>**

<sup>1,2,3</sup>*Kulliyyah of Architecture and Environmental Design,*  
INTERNATIONAL ISLAMIC UNIVERSITY MALAYSIA

### **Abstract**

Agro-tourism is more than just a tourist product. It is a journey to a new sensation or positive behavior concerning the environment, the community and culture. It also one of the diversified sub-sectors that provide opportunities and choices for the rural community, commonly associated with agricultural activities to enhance and maintain their economic sustainability. This research focuses on the quantification of tourism sector income specifically related to agricultural destinations, activities, and products, evaluated in the selected communities that offer tourists visits and stays within the former's villages or settlements. Income derived from the activities, destinations, and products are to be reported and assessed against initial investment and annual operating costs. This is an area mostly void of literature, especially those within the Malaysian contexts. The research aims at exploring the vitality and robustness of agro-tourism based homestay activities in Terengganu. Three objectives have been developed based on the gaps in existing literature. Firstly, the research is to identify offerings of homestay destinations, activities, and products relevant to agriculture sector within the rural communities of Terengganu. Secondly, the research is to assess the income received from these activities based on communal receipts as well as individually reported revenues. Finally, the research is to recommend strategic and focused areas of improvement to increase and sustain the competitiveness of agro-tourism sector delivered through homestays operation. The methods used in this paper were the semi-structured interview and focus group discussion. 76 respondents participated in the discussion.

**Keyword:** homestay, agro-tourism, homestay operation, tourism, Terengganu

<sup>1</sup>Associate Professor at International Islamic University Malaysia. Email: syahriah@iiu.edu.my

## **INTRODUCTION**

Tourism is one of the ways to increase the economy of the country. In 2016, there were 26.76 million tourist arrivals in Malaysia with total receipt of RM82.1 billion. This is a slight increase from the previous year which is 25.7 million tourists with the total receipt of RM69.12 billion (MOTAC, 2016). In the 11th Malaysian plan, the government's focus is on the development of rural communities through transforming rural areas to elevate well-being of rural communities. The rural population involved in agricultural activities and have dwelling facilities to offer experiences of cultural and agro-based daily activities were facilitated to engage in income generation opportunities. Then, the Ministry of Tourism and Culture of Malaysia introduced a homestay program in 1988 as an alternative accommodation for tourists (Kayat & Mohd Nor, 2006). A homestay is a form of accommodation where tourists will be able to live with selected host families and have the opportunity to interact and experience the daily way of life of the family and culture directly Malaysia (MOTAC, 2014). Abdul Razzaq et al. (2011) stated in their research that the income of homestay operators increased from RM1000 to RM1500 after their participation in the homestay program. There are many Malaysian tourism products introduced to the tourist through homestay programs. Besides exploring the vitality and robustness of agro-tourism based homestay activities in Terengganu, a state which is rich with natural resources and cultural heritage, the problem faced by homestay owners should be highlighted. Mohd Nor and Kayat (2010) mentioned in their study that challenges faced by homestay owners might affect the success of homestays program. This paper is organized as follows. In section 2, there will be an enlightenment on related case study area. In section 3, the methodology used in acquiring data. The results from the data analyzed are also presented in section 4. Finally, the work of this paper is summarized in the last section.

## **CASE STUDIES**

Among the important rural tourism in Malaysia is homestay programme. It is a community-based programme where tourists can have interaction and direct experience of the day-to-day life of the community (Bhattarai, 2012). Besides, Boonratana (2010) and Pusiran & Xiao (2007) supported that homestay provides an excellent opportunity to tourists to experience the way of life of the local people of an area along with the indigenous and traditional cultures within a comfortable home setting. It is a program under the Rural Tourism Master Plan, which aims to encourage the participation of rural communities in the tourism sector.



**Figure 1:** Location map of Terengganu

In Terengganu, there are ten (10) registered homestays that were actively operating. Figure 1 shows the map of Terengganu clustered homestays that were operated under Ministry of Tourism and Culture (MOTAC). Homestay development was partially developed around agro-based industry including small rural centers in Felda settlements. In fact, two of registered homestays in Terengganu was located at the heart of Felda settlements (MOTAC, 2014).

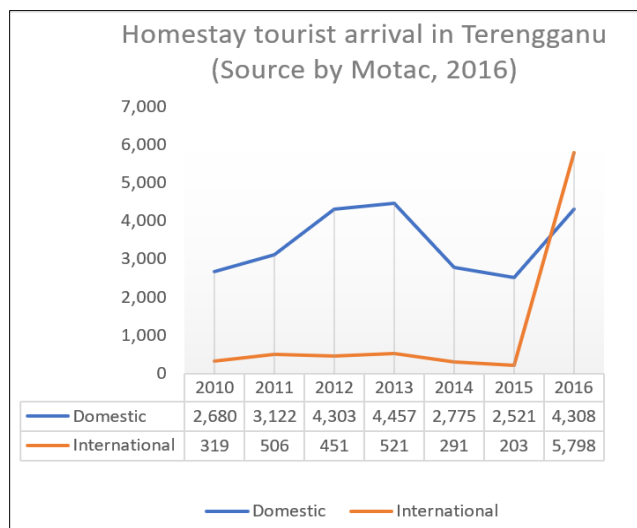


Figure 2: Homestay tourist arrival

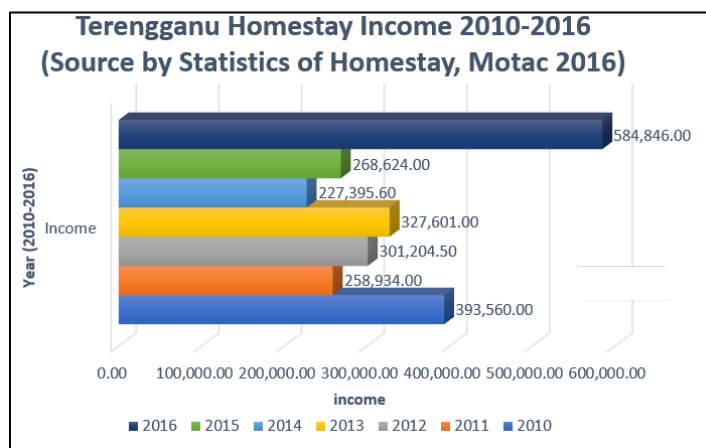


Figure 3: Terengganu homestay income

Figure 2 above shows the Terengganu tourist arrival of homestay for the year 2010 – 2016. The number of tourists was increasing starting from 2010 until 2013. However, the number fluctuated after year 2013. Same goes for the income of Terengganu homestays. The income fluctuated between year 2010 and year 2015 (Figure 3). However, the income increased between year 2015 and 2016.

## **METHODOLOGY**

### **Data Collection**

There were two types of data collection which were secondary and primary data. For the secondary data, the data was collected from tourism local authorities. For the primary data, semi-structured interview and focus group discussion session were carried out on homestay operators in identifying factors relating to homestay programs, activities of agro and non-agro based, and income generated. The questionnaire survey consisted of the sociodemographic part, operational homestay and also income part. There were 76 homestay operators from eight (8) homestays that participated in the interview sessions. They were Homestay of Felcra Keruak (8), Homestay of Teluk Ketapang (5), Homestay of Felda Selasih (18), Homestay of Jerangau (9), Homestay of Kg Pasir Raja (20), Homestay of Rhu 10 (5), Homestay of Kubang Depu (6) and Homestay of Seri Bandi (5).

### **Sampling and Data Analysis**

The focus group discussion (FGD) was conducted between enumerators and homestay operators on an agreed date during the weekend. The head of the homestay gathered as many homestay operators as possible. The moderator briefed on the questionnaires prior to answering the questions. The survey was assisted by the enumerators. Each enumerator had three to five homestay operators to be assisted. 76 homestay operators had been voluntarily interviewed during FGD. Then, transcription work would be conducted using SPSS to highlight frequency, pattern, and trends in the responses. Test of significance were conducted on factors influencing the motivation, success, and failure of homestay concept and operations.

## **DATA ANALYSIS AND RESULTS**

### **Sociodemographic**

The first part of questionnaire survey and session of focus group discussion was on the homestay owners' sociodemographic profile. Table 1 shows the frequency distribution of each socio demographic profile variables including gender, age, employment, household members and monthly household income. The highlighted number indicated the highest frequency of homestay owners. It was discovered that most of the homestay owners was self-employed females aging between 50 and 59 years old. The number of households was the factor of their participation in homestay programs. Most of the operators or homestay owners live together with their spouse and most of them had a child. The majority of homestay owners were low-income earners with monthly income of RM1000-1999.

**Table 1: Sociodemographic of homestay operators**

Sociodemographic	Descriptions	(fq)	%
Gender	Male	25	32.8
	Female	<b>51</b>	<b>67.2</b>
Age	19-39 (y/o)	5	6.5
	40-49 (y/o)	15	19.7
	50-59 (y/o)	<b>29</b>	<b>38.1</b>
	60-69 (y/o)	27	35.5
Employment	Self-employed	<b>37</b>	<b>48.7</b>
	Private Sector	9	11.8
	Public Sector	11	14.5
	Retiree	9	11.8
	Housewife	10	13.2
Household members	0-1 person	<b>55</b>	<b>72.3</b>
	2-3 person	18	23.6
	4-5 person	3	3.9
Household monthly income (RM)	Below 999	17	22.3
	1000 - 1999	<b>25</b>	<b>32.8</b>
	2000 - 2999	20	26.3
	3000 - 3999	9	11.8
	4000 - 4999	3	3.9
	5000 above	11	14.4

### Homestay Operations

Data collection of homestay operations consists of the year of start, homestay investment, break-even, homestay monthly expenses and subsidy as stated in Table 2 below. Based on Table 2, all the homestay owners received training from MOTAC and INFRA. Majority of homestay owners started the operation of the homestays since year 1996 (34.2%). Since most of the homestay owners invested less than RM2000, the break-even period was shorter; within 5 years. The monthly expenses of homestay were also mostly in the range of RM100 to RM999. Only 19.7% of homestay owners received subsidy from MOTAC. Based on the discussion with the homestay operators, the subsidy received after homestay inspections from MOTAC officers covered room and toilet renovations.

**Table 2: Homestay operation**

Operational of homestay	Description	(fq)	%
Year of start	<b>1996</b>	<b>26</b>	<b>34.2</b>
	2003	7	9.2
	2009	16	21
	2013	4	5.2
	2014	8	10.5

	2015	1	1.3
	2016	9	11.8
	N/A	5	6.5
Training	<b>Yes</b>	<b>76</b>	<b>100</b>
	No	0	0
Initial Investment (RM)	<b>below 2000</b>	<b>49</b>	<b>64.4</b>
	2001-4999	2	2.6
	5000-7999	11	14.4
	8000 above	14	18.4
Expected Break-even	<b>0-5 years</b>	<b>46</b>	<b>60.5</b>
	5-10 years	8	10.5
	11 years above	8	10.5
	N/A	14	18.4
Homestay monthly expenses (RM)	<b>100 – 999</b>	<b>40</b>	<b>52.6</b>
	1000 – 1999	27	35.5
	2000 above	9	11.8
Subsidy	Yes	15	19.7
	No	61	80.2

### Stayers of Homestay

The requirement of homestay program participation was the provisions of a minimum of one standard room. The room should not be separated outside of the house. Most of the homestay owners provided one room for tourist with the percentage of 57.8%. The rental cost of homestay was normally standardized by the head of the homestay. Based on table 3 below, the majority of the owners charged between of RM51 and RM100 per night and per person (including food). An average number of tourist were two or three persons monthly with the minimum stay of duration of two nights (55 %).

**Table 3: Stayers of homestay**

Stayers of homestay	Description	Fq	%
	<b>1</b>	<b>44</b>	<b>57.8</b>
Rooms	2	22	28.9
	3	4	5.2
	4 above	6	7.8
	RM50 below	27	35.5
Rental cost (RM)	<b>RM51-RM100</b>	<b>44</b>	<b>57.8</b>
	RM101 above	5	6.5
Monthly No. of tourist	<b>1-2 person</b>	<b>54</b>	<b>71</b>
	3-4 person	11	14.4
	5 person above	6	7.8
	N/A	5	6.5
	Stay durations	1 night	3



<b>2 nights</b>	<b>55</b>	<b>72.3</b>
3 nights	9	11.8
4 nights above	4	5.2
N/A	5	6.5

### Homestay activities and products

The geographical aspect of location was also important in identifying the attraction such as visiting the indigenous at homestay of Felcra Keruak, and hiking to Gunung Tebu at homestay of Kg Pasir Raja. The first objective of identifying the homestays destination, activities and products was achieved. Table 4 shows that the highest percentage of homestay activities were traditional culture, cooking traditional food, village touring, agriculture product and handicraft with the percentage of 94.7%, 92.1%, 89.4%, and 84.2% respectively. The activities based on homestays were shown in Table 5.

**Table 4: Homestay activities and products**

Tourism Activities	Yes		No		Total	
	(%)	Freq	(%)	Freq	(%)	Freq
1. Rubber tapping	47.3	36	52.6	40	100.0	76
2. Palm oil processing	53.9	41	46.0	35	100.0	76
3. Aquaculture	44.7	34	55.2	42	100.0	76
4. Fishing/ boat trip	57.8	44	42.1	32	100.0	76
5. Turtle hatching	5.2	4	94.7	72	100.0	76
6. Agriculture product & handicraft	<b>84.2</b>	<b>64</b>	<b>15.7</b>	<b>12</b>	<b>100.0</b>	<b>76</b>
7. River cruising	69.7	53	30.2	23	100.0	76
8. Village touring	<b>89.4</b>	<b>68</b>	<b>10.5</b>	<b>8</b>	<b>100.0</b>	<b>76</b>
9. Fireflies watching	13.1	10	86.8	66	100.0	76
10. Traditional culture	<b>94.7</b>	<b>72</b>	<b>5.2</b>	<b>4</b>	<b>100.0</b>	<b>76</b>
11. Visiting historical sites	57.8	44	42.1	32	100.0	76
12. Cooking traditional food activity	<b>92.1</b>	<b>70</b>	<b>7.8</b>	<b>6</b>	<b>100.0</b>	<b>76</b>

**Table 5: Homestay activities based on location**

Homestay	Activities based on homestay											
	1	2	3	4	5	6	7	8	9	10	11	12
Felcra Keruak	√	0	√	√	0	√	√	√	0	√	√	√
Teluk Ketapang	√	0	√	0	0	√	√	√	√	√	√	√
Felda Selaseh	√	√	√	√	√	√	√	√	0	√	√	√
Jerangau	√	√	√	√	0	√	√	√	0	√	√	√
Pasir Raja	√	√	√	√	0	√	√	√	0	√	√	√
Rhu 10	0	0	√	√	0	√	√	√	√	√	√	√

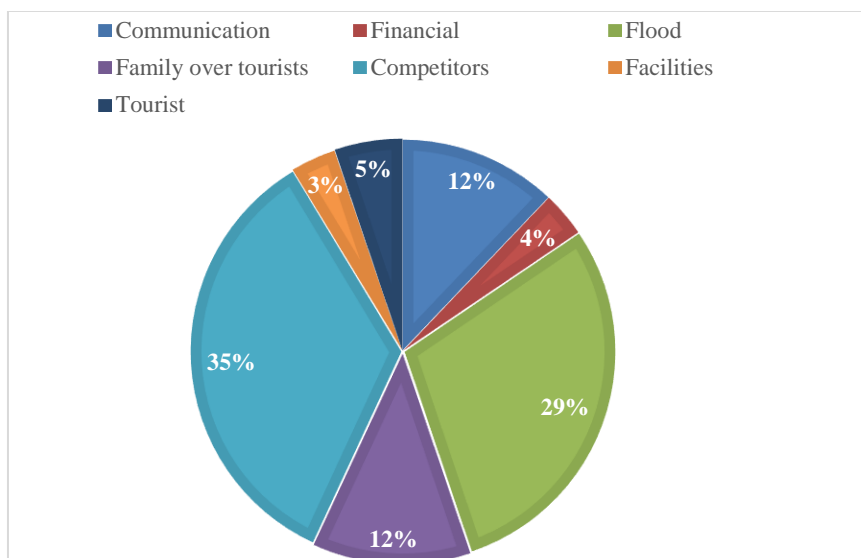
Kubang Depu	√	√	√	√	√	√	√	√	0	√	√	√
Seri Bandi	√	√	√	√	√	√	√	√	√	√	√	√

### **Homestay Program Income**

In order to achieve the second objective of this study, the income received from the homestay products was assessed. Income of homestays was generated from the homestays fee including stays, food, activity and also from the selling of local product such as souvenir, fish chips, fruits, kelulut-honey and others. 43% of homestay owners or operators had an average income of RM 101 to RM 300 per month. The dependency of income on homestay program was weak, hence to continue the homestay program seemed futile. However, most of the owners participated in this program due to their interest and wished to remain in the homestay business.

### **Possible Challenges**

The challenges that were faced by the homestay owners was recorded during the discussion. Figure 4 below shows that competitor was the main problems challenged by homestay owners (35%). The misunderstanding of the homestay concept was due to unregistered rental house or accommodation operators that used the term 'homestay' for their business. Thus led to confusion among tourists. The second highest was the natural disaster (flood) especially in the area of Jerangau Homestay (29%). The geographical aspect of location and improper drainage planning were the factors of the flood during heavy rain especially between November and January. The priority of family over tourists during the holidays and communication barriers also posed as challenges (12% respectively).



**Figure 4:** Possible challenges

**CONCLUSION AND RECOMMENDATIONS**

There are several conclusions and recommendations that can be made from the results. The identification of destinations, activities and also tourism products was derived from the site visits. Homestay program benefits the community and it is the secondary tourism package for the tourists. The government should formulate the homestay policy and enhance the program since the program acquire the common interest from both the locals and the tourists. The income that was generated from the homestay program was low which range from RM 101 to RM 300 per month. It was stated that the problem faced by the homestay operators influenced the tourists’ options. The term ‘homestay’ is referred to the homestay program under the supervision of MOTAC. It should strictly be used befittingly to avoid further confusion among tourists. The drainage system should also be properly managed to control the flood. Additionally, the enhancement through professional workshop of basic communication and promotion skills is crucial. Homestays should be located according to specialty and availability of tourism activities at respective location. For example; Homestay of Teluk Ketapang was located at the center of Kuala Terengganu. The tourists were introduced to the cultural activity such as traditional cuisine preparations, local traditional dancing, traditional musical instruments and also crafting. The Felda Keruak Homestay was more related to the agro-based activity such as farm visit.

**ACKNOWLEDGEMENT**

This work was supported in part by International Islamic University of Malaysia under Grant Nos. SP16-034-0247

## REFERENCES

- Abdul Razzaq, A. R., Hadi, M. Y., Mustafa, M. Z., Hamzah, A., Khalifah, Z., & Mohamad, N. H. (2011). Local community participation in homestay program development in Malaysia. *Journal of Modern Accounting and Auditing*, 7(12), 1418-1429.
- Bhattarai, T. (2012, September 10). Homestay Boost Tourism in Rural Nepal. *Global Press Journal*. Retrieved from <https://globalpressjournal.com/asia/nepal/homestays-boost-tourism-in-rural-nepal/>
- Boonratana, R. (2010). Community-based tourism in Thailand: The need and justification for an operational definition. *Kasetsart Journal of Social Sciences*, 31, 280-289.
- Kayat, K. & Mohd Nor, N. A. (2006). Penglibatan ahli komuniti dalam Program Pembangunan Komuniti: Satu kajian ke atas program homestay di Kedah. *Akademika*, 67, 77-102.
- Ministry of Tourism and Culture [MOTAC] (2014). *Malaysia homestay statistics*.
- Ministry of Tourism and Culture [MOTAC] (2016). *Malaysia homestay statistics*.
- Mohd Nor, N. A. & Kayat, K. (2010, December). The challenges of community-based homestay programme in Malaysia. *Regional Conference on Tourism Research*. December 13-14, 2010, Penang, Malaysia
- Pusiran, A. K., & Xiao, H. (2013). Challenges and community development: A case study of homestay in Malaysia. *Asian Social Science*, 9(5), 1-17.



**HOMESTAY OPERATION UNDER THE PURVIEW OF THE  
MINISTRY OF TOURISM AND CULTURE OF MALAYSIA: THE  
CASE OF KELANTAN HOMESTAY OPERATORS**

**Syahriah Bachok<sup>1</sup>, Hafizah Hasbullah<sup>2</sup> & Syakir Amir Ab Rahman<sup>3</sup>**

*<sup>1,2,3</sup>Kulliyyah of Architecture and Environmental Design*  
INTERNATIONAL ISLAMIC UNIVERSITY OF MALAYSIA

**Abstract**

This research outlines the selection, registration, operation and management of formal homestays under the purview of Ministry of Tourism and Culture of Malaysia. Using a case study of Kelantan, the research further elaborates on the inception of such concept in Malaysia, the process and procedures for establishment of homestay operation as well as the maintenance and upholding qualities of the current operational homestays. One of the largest contributing sectors to the Gross National Product in 2015, tourism offers great and various activities to tourists domestic and international alike. One such activities is agro-tourism that provide opportunities for the visitors to stay and experience the life of an agriculture community in rural areas of Malaysia. Kelantan being one of the most remote areas in the Peninsula is still rich with natural resources and agricultural produce has the advantage of showcasing the unique attractions to various tourists' types, especially those who were willing to stay overnight or more to properly enjoy and learn about realities of daily life of these selected communities. A gap in the literature identified that research on how these communities were selected to offer such activities while maintaining their identities are scantily available. Hence, this research aims at explaining the processes of registering of homestays and rooms for tourists stay and identifying improvement areas which can be targeted to increase the income receipts from this specialised yet diversified sector.

**Keywords:** homestay, agro-tourism, homeowners, tourism, Kelantan

## **INTRODUCTION**

Homestay is a term explaining travellers' or tourists' staying in a room or some parts of a complete house in pursuit of experiencing cultural and traditional way of local (often rural) community living. Culture includes lifestyles, values and norms adopted an ethnic group. Normally, a culture depicted is through the language, food and beverages, clothing, behaviour and arts (music, dance and drama), which has a strong influence on the political and organizational structure in place. Cultural tourism is a tourist activity involving the exploration, appreciating and enjoying the culture of other ethnic groups (Ibrahim & Ahmad, 2009). The factors that encourage the promotion of the development of cultural tourism is the desire to learn, seek and establish one's origin, apart from understanding, deepen and gain new experience about the way of life and customs of a society that is foreign to them. This growing cultural tourism market has been tapped economically by the promotion of the concept of homestay tourism

In Malaysia, the official homestay program is under the purview of the Ministry of Tourism and Culture Malaysia (MOTAC). The main actors of the program are the accommodation on offer, the tourists or travelers willing to stay a minimum of an overnight and also the host families that provides basic necessities for the stay to be enjoyable (MOTAC, 2014). MOTAC adopted a different procedure from those homestay concepts practiced abroad. The Malaysian concept emphasized that tourists stay with host families and daily activities together. In some parts of the globe, the concept applies just simply when a tourist stays and enjoys breakfast. In other words, tourists are not involved in village activities together with a host family (Aminudin & Jamal, 2006). For examples, homestay concept in the United Kingdom and the United States is more concerned with the motivation to improve proficiency in English language skills among students.

This paper highlights the origin of homestay in Malaysia, identifying the key actors of its development, the process of initiating and selecting the prospective owners and accommodation as well as investigating the distribution of income or revenue from the rental receipts. The approach taken by this research is qualitative in nature, limiting itself to only describing and elaborating the subject matters.

## **CASE STUDIES**

In Malaysia, homestay development is partially developed around agro-based industry including small rural centres in Felda settlements. The program was first launched in 1995 at Temerloh, Pahang by the then Minister of Culture, Arts and Tourism Malaysia. It was a program under the Rural Tourism Master Plan, which aimed to encourage the participation of rural communities in the tourism sector. Homestay accidentally started in the early 1970s by a local resident who was known as *Mak Long* in a Cherating village, Pahang. She began providing

accommodation and food (breakfast and dinner) in her house to a group of "drifter" tourists (Hamzah, 1997).

Kelantan is an eastern coast state of Malaysia, rich with unique culture, beautiful beaches, distinctive rural living, active commercial activities, making it very attractive and competitive as a tourist destination. Table 1 outlines the homestay locations and the respective owner operators in Kelantan.

**Table 1:** List of homestay in Kelantan

No.	List of homestays in Kelantan	No. of owners
1.	Homestay Kg. Pantai Suri, Tumpat	20
2.	Homestay Renok Baru, Gua Musang	20
3.	Homestay Bukit Jering, Jeli	20
4.	Homestay Kg. Kubang Telaga, Bachok	32
5.	Homestay Kg. Batu Papan, Gua Musang	12
6.	Homestay Seterpa, Kota Bharu	29
7.	Homestay Kg. Jelawang, Dabong	9
8.	Homestay Kemunchup, Machang	10
TOTAL		152

The figure below shows the annual tourists arrival, staying in Kelantan's homestay. It can be argued that while tourists' arrival to Kelantan was plenty, some 5% from the total Malaysian statistics (26.76 millions), the demand for homestays was slightly unpromising, with stayers ranging around 3000 to less than 11,000 annually (MOTAC, 2016).



**Figure 1:** Homestay tourist arrival in Kelantan  
*Source: MOTAC, 2016*

## **METHODOLOGY**

The research deployed two data gathering methods namely primary and secondary. Primary data collection was conducted by field study site visits, identifying the infrastructure and homestay operations while interviews were carried out with officers from relevant agencies, confirming the processes and procedures of selection, operation, monitoring and regulating the homestays. As such, focus group discussion were undertaken from August, 2016 until February 2017 at homestay locations as well as at the offices of the relevant agencies. In total, this research collected 54 interviews with homestay owners.

## **DATA ANALYSIS AND RESULTS**

### **Homestay Registration and Operation**

The homestay program is usually run by the local residents in the rural areas. The official homestays, as recognized by the ministry has to undergo various processes and procedures, established under statutes of various Ministries. The most important agency is MOTAC. It will only issue recognition award and license to house owner who fulfils the homestay criteria and regulation. These criteria include adequate facilities for tourists such as a separate bedroom and bathroom and accessibility to the main road. The owners also having no history of criminal record and not suffering from any communicable diseases and high standard of hygiene. MOTAC also provides directions, policies and guidelines for the development of Homestay program, provides funds for tourism infrastructure development, grants to upgrade homes of homestay owner, market and promote through Tourism Malaysia and work closely with state agencies such as State Tourism Action Council, Economic Planning Unit.

The second agency is the Ministry of Rural and Regional Development (MRRD), responsible for providing the infrastructure for rural development such as public toilets, community multi-purpose halls, public walkways, improved landscape and jetty (MOTAC, 2016). Institute for Rural Advancement (INFRA) is a training institute under MRRD that provides training for the rural community including homestay operators as well as the Village Security & Development Committee (JKKK) (MOTAC, 2016).

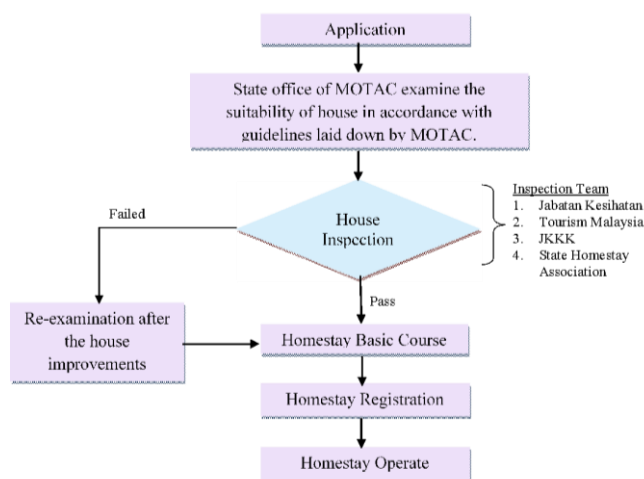
Malaysian Tourism Information Centre or MATIC is another important agency. State Office of Tourism Malaysia's responsibility is promoting and providing information relevant to homestays and tourist destinations, facilities and amenities. Tourism Industry Act 1992 is the statutes focusing on the aspects of transportation, food, price and other things related to program packages. MOTAC audit duration and courses were conducted to ensure compatibility and quality levels are consistent over the years. MOTAC has always taken initiatives to avoid confusion of services offered by registered homestays under the



Ministry, and to curb issues of non-registered homestay. These include (MOTAC, 2014):

- i. Close cooperation with the local authorities to address the issue of illegal homestay operators;
- ii. Advising local authorities to be more stringent in issuing business license for accommodation premises when using the term "homestay";
- iii. Advising company Commission of Malaysia (Suruhanjaya Syarikat Malaysia-SSM) to consult MOTAC of any application for company registration using the term "homestay"; and
- iv. Imposition of the usage of the Malaysia Homestay Experience Logo under the provisions of the Trade Marks Act 1976 and Trade Marks Regulations 1997 by the registered homestay for quality, safety and security assurance

MOTAC’s visit and recognition were important in sustaining and maintaining the quality of homestays in Kelantan. The visit runs every three years. A village selected to involve in the homestay program must meet specific criteria and comply with guidelines issued by MOTAC in order for homestay programs to be carried out effectively and efficiently. Recognition process started from the date when an application to join the homestay program was made. The homestay program is open to all Malaysians owning or occupy a home in Malaysia. Malaysians that wish to join the homestay program are required to register with MOTAC.



**Figure 2:** Flow chart homestay registration process

Figure 2 shows the flow chart homestay registration process. Before registering with MOTAC, each homestay owner has undergone and must pass a house inspection that was supervised by MOTAC. The agencies involved with the inspection are the Department of Health, Tourism Malaysia, Village Security & Development Committee (JKKK) and State Homestay Association. Other than that, Homestay owners also need to attend Homestay basic course organized by (INFRA and Ministry of Rural and Regional Development).

Ministry of Agriculture (MOA) is the fourth main agency involved. Agricultural products were amongst local attractions since the venues of homestay were located in rural areas. Hence, the MOA focuses in financial and technical assistance to improve the agriculture activities in homestays area (MOTAC, 2016).

Additionally, individual homestay operation must possess specific characteristics (Table 2) for homestay programs as prescribed by the MOTAC (2016). During ground truth surveys and field study visits, these were observed and confirmed

**Table 2:** Characteristics for homestay programs

Residential location	The location should be in the strategic area in terms of transportation and free from pollution. Have a suitable environment besides displaying the lifestyle of Malaysian society.
Basic facilities	The guest bedroom is separated from the other bedrooms in the house. To ensure the comfort of the host's family members and guests, the maximum number of rooms permitted for visitors is limited to four decent sized bedrooms. Usually, one bathroom is attached inside the guest room. The visitors' comfort should be prioritized and the premises must have proper bathrooms, toilet facilities, dining and living room as well as other basic amenities. Preparation and supply of meals, towels, and other things upon the visitors' request. Basic facilities should be well maintained to ensure the cleanliness of the premises and the comfort of the visitors.
Cleanliness	The home area should be clean and clear of rubbish. Efficient waste disposal and drainage should be ensured to avoid unpleasant odors.
Safety	Insurance coverage is necessary to protect visitors. For tour groups brought in by travel agencies, insurance coverage should be handled by the tour company. The host is advised to take out an insurance policy from any registered insurance company for the protection of individual visitors.
Guidelines for food preparation	The storage and handling of food and running of food premises must be paid close attention. The cleanliness of these premises needs to be maintained and all unused containers (boxes, bottles,

---

	etc.) which can become a breeding ground for 'vermin' such as mice and insects should be disposed off properly. Garbage must also be collected and disposed off frequently while waste disposal areas and containers must be cleaned regularly.
Equipment and appliances	All equipment and appliances used in the preparation and handling of food should be appropriate to prevent food poisoning. Equipment and appliances should be washed after use and kept in sanitary conditions.

---

*Source: MOTAC, 2016*

The clustered homestay under MOTAC were observed to have possessed these qualities too (MOTAC, 2016):

- i. Have a minimum number of 10 registered Homestay providers within the clustered Homestay to reflect community involvement and cohesion;
- ii. Be accessible to any mode of transportation and communication;
- iii. Embrace think and act tourism mind-set;
- iv. Maintain a high level of security, safety and cleanliness;
- v. Offer rural based and traditional activities such as fishing, traditional games, cultural performances and rubber tapping (agro-based, eco, cultural-based tourism).

Participation in a homestay program would to gain knowledge of external culture, acquire skills in greeting and receiving guests and be able to expand participation in their Small Medium Enterprise (SME) business as witnessed during ground truth survey and field study visits.

### **Issues and Problems**

During interview sessions with the 54 owners and operators of homestays, the research team has discovered a few problems faced by them. Such as, the decreasing number of tourist arrivals which could not generate additional income as expected or sustain Homestay operation. Based on current scenario of abundance of accommodation, majority of them were not satisfied with the operating of unregistered homestays (not registered with MOTAC) and other types of accommodation. This is because homestay operators have to compete with these competitors. The misused or manipulated concept of homestays is another issue facing the operators. Abusive activities by commercial operators illegally calling themselves as homestays have negatively impacted the income and revenue of the officially registered homestay communities.

Another issue was the miscommunication between owners and visitors. Failure in good communication would cause difficulties in interaction with the foreign tourists. Good communication between both parties increases the intensity and enjoyment of the homestay experience. Whenever both parties are impeded by a lack of communication skills or mastering of an international

language, the intensity and goals of the program are affected (Pusiran & Xiao, 2013). Communication skill is important for each homestay owner because they have to interact with tourists of either from within or outside the country., Homestay owners interested to learn English as learning English would not only benefit them but also would enhance the tourism industry in their area. They would be able to communicate with the foreigners.

During the interview, it was found that the homestay communities also faced problems such as the lack of commitment and cooperation among some operators, the disintegrated community and lack of leadership quality. For homestays to work, the relationship between the communities must be very strong as it is a purely service-oriented concept of tourism. Cooperation and coordination to run homestay program among community is a must, otherwise it can bring about conflicts in the future.

Due to differences in culture, some tourist behavior is perceived by operators as culturally inappropriate that may create socio-cultural problems in the area. Since tourists stay in a local social environment, they need to be respectful to preserve local traditions, stimulates cultural exchange and cooperate with the local residents

#### **Room Distribution and Allocation**

The process of selection of houses/rooms on offer for different visitors was normally randomly distributed between/among the homestay owners (Figure 3). Important and prominent leaders of the group such as lecturer, teacher or group leader, would stay in the house of the chairman of association/the head of JKKK or special chalets provided by homestays. Usually, two persons will occupy/share a room. In order to ensure fair visitors' distribution among all participants, the chairman of association or head of JKKK was a person in charge in allotting guests to the different homestays. Visitors were divided among the owners who had the lowest amount of visitors for that period. Whenever a member was unable to be a host because of family affairs, holidays or any personal reasons, the next member in line was selected. Walk-in guests were referred to the chairman of association or head of JKKK by the tourism office and he/she would provide/allocate the visitors/guests to various possible homestay options.

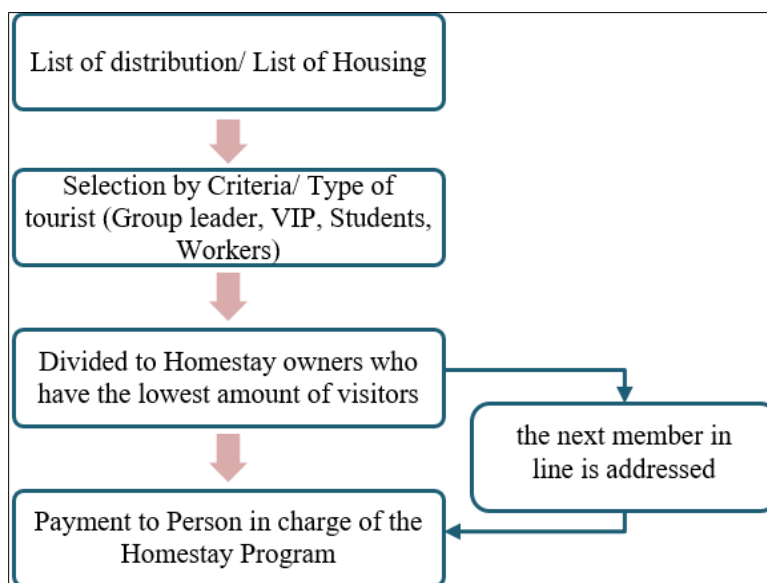
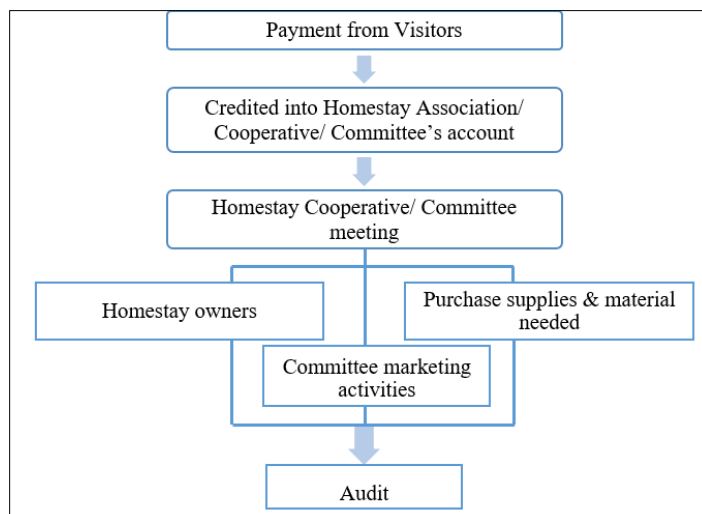


Figure 3: Room selection and distribution

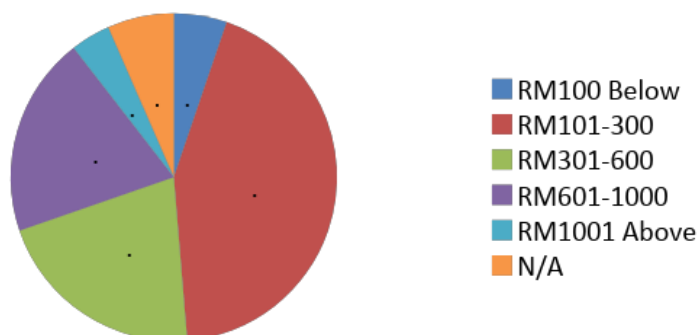
### Homestay Income and Receipts Distribution

During the focus group discussion, the researcher found out that these clusters were managed by coordinating groups, such as the homestay program committee. Some homestay program committees were the extensions of the Village Security & Development Committee (JKKK) and others were registered co-operatives. Money received from rental of rooms in homestay was distributed in systematic manners (refer Figure 4). Most tourists/visitors came in groups and the package for the homestay program for two days, one night inclusive of meals, ranging from RM60-90 (USD 15-23), depending on the activities that were included in the itineraries. Payments received from a group of visitor would then be credited into Homestay Association or Committee's account. Each homestay owner was paid RM30-150 (USD 8-35) for each hosted visitor per night. Profits were used by the committee marketing activities and for the procurement of supplies and material needed for subsequent activities.

An approximation of annual income by homestay source can be calculated by the participants. However, these figures should not be taken as the guiding amount of annual overall income of the participants, as they may have a formal day job, and side incomes from other business and activities. Figure 5 shows that homestays activities were only generating from RM101-RM300 annually (as reported by 33.43 percent of respondents). Less than 3.4 percent had homestays generating more than RM1,000 annually.



**Figure 4:** Income / revenue distribution flow



**Figure 5:** Kelantan homestay income

## CONCLUSION AND RECOMMENDATIONS

To conclude, homestays are potential income sources for rural communities, commodifying their unique culture and agricultural produce to be marketed as tourism products. However, there exist numerous agencies and multi-layered and -faceted sets of rules and regulations of the operation of homestay program that can sometime put unnecessary pressure on the owners. These agencies should be focusing on providing and upgrading the hard infrastructure such as road networks, telecommunications, renovation and upgrading schemes of buildings, structures and communal facilities to be used by tourists staying with host families.

Confusion and abusive use of the concept homestays by illegal commercial operators were deemed as threats to the homestay owners registered with the authorities. In order to sustain and ensure the longevity of these rural homestays, they must strategies to rigorously promote and package their unique and distinctive rural lifestyle and remote locations, at both regional and global levels. In addition to that, the government specifically MOTAC need to control the illegal commercial operators by increasing resources as well as strengthening legislations and technical capacities to enhance the effectiveness of implementation and enforcement.

Quality control on selection process and operation have been very tight, but income remained low that some of the homestay have ceased operations, partly due to hefty competition. Hence, in addition to central and state agency promotion and packaging, owners and operators must equip themselves with skills and technical know-how to face contemporary challenges and issues described earlier.

#### **ACKNOWLEDGEMENTS**

This work was supported in part by International Islamic University of Malaysia under Grant Nos. SP16-034-0247.

#### **REFERENCES**

- Aminudin, N., & Jamal, S. A. (2006). *Homestay Selangor: Keunikan dan pengalaman pengusaha*. Shah Alam: Pusat Penerbitan Universiti, Universiti Teknologi MARA.
- Hamzah, A. (1996). The evolution of small-scale tourism in malaysia: problems, opportunities and implications for sustainability. In M. J. Stabler, *Tourism and sustainability: Principles to practice* (pp.199-217). Wallingford: CAB International.
- Ibrahim, J. A. & Ahmad, M. Z. (2009, June). Program homestay pemangkin pertumbuhan ekonomi luar bandar, kajian kes: Negeri-negeri utara Semenanjung, Malaysia. *Persidangan Kebangsaan Ekonomi Malaysia (PERKEM IV)*. June 2-4, 2009, Kuantan Pahang, Malaysia.
- Ministry of Tourism and Culture [MOTAC] (2014). *Malaysia homestay statistics*.
- Ministry of Tourism and Culture [MOTAC] (2016). *Malaysia homestay statistics*.
- Pusiran, A. K., & Xiao, H. (2013). Challenges and community development: A case study of homestay in Malaysia. *Asian Social Science*, 9(5), 1-17.



## **THE RELEVANCY OF OUTDOOR CLASSROOM FOR PBL APPROACH IN SELECTED UNIVERSITY IN KUALA LUMPUR**

**Maheran Yaman<sup>1</sup>, Fadzidah Abdullah<sup>2</sup>, Nur Fadhilah Rozali<sup>3</sup>, & Farha  
Salim<sup>4</sup>**

<sup>1,2,3,4</sup>*Kulliyyah of Architecture and Environmental Design,*  
INTERNATIONAL ISLAMIC UNIVERSITY MALAYSIA

### **Abstract**

Outdoor classroom could be described as outdoor learning space that provides varying experiences and learning activities that could enhance students' learning performances, particularly in Problem Based Learning (PBL) approach. It also has become the main role in providing effective and dynamic learning environment for PBL practices. By investigating the relationship between the outdoor classroom and the students' PBL approach, one could reveal the interconnectedness between the outdoor classrooms in campus settings with the students' learning performances in PBL approach. Hence, the objective of this study is to analyze the relevance of outdoor classroom in adapting PBL approach in selected universities in Malaysia. A questionnaire survey, was conducted among landscape architecture and architecture students in UIAM, UPM and UiTM Puncak Alam. The results of this study confirm that outdoor classroom improves students learning performances, particularly in designing skills and work presentations. Furthermore, the results also indicate that outdoor classroom enhance students' ideas and inspiration in designing.

**Keywords:** outdoor classroom, PBL approach, campus informal learning, students' learning performances

<sup>1</sup>Assistant Professor at International Islamic University Malaysia. Email: maheran@iium.edu.my



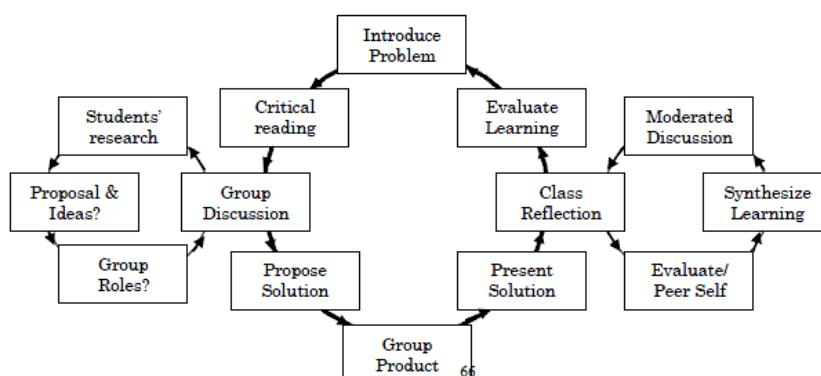
## **INTRODUCTION**

Problem Based Learning is a learning method that instructs students to develop their own investigation, research and construct their own solutions. It requires critical thinking with open-ended problems and facilitates by tutors and students in a small group. The PBL approach enables students to become actively participate in group work and develop viable learning solutions through self-directed learning.

Group learning activities assist students in sharpening their communication skills, independent responsibility in sharing information and problem solving as well as learning to respect to other members. In other words, PBL is defined as '*...specific attributes as being student-centered, taking place in small groups with the teacher acting as a facilitator, and being organized around problem*' (Graaff & Kolmos, 2003).

By definition, PBL is a pedagogical approach that uses 'real problem' as a trigger to problem-solving, in a way students understand the problems and encourage to find the new solutions and organize existing knowledge (Surif, Ibrahim & Mokhtar, 2013). The principle idea of PBL is that the students is the problem solver and the facilitator monitors and guides students in the learning process. By PBL approach, students develop their problem-solving skills, personal skills, and social skills, as well as motivate themselves to learn new concepts and ideas through group discussion and formal conversation with the tutors.

Goodman (2010) summarizes the learning process in PBL by introducing the problems followed by the critical readings and identify the related issues (Figure 1). Next, a group discussion is established to do research and formulate ideas up to reaching proposal stages. Then, the outcomes are presented and discussed in the class, followed by the assessment to improve in group learning. Lastly, the discussion is made to proposed solutions and the final assessment is done through the implementation of successful problem-solving objectives.



**Figure 1:** Learning process using problems

## **PBL NEW PEDAGOGICAL APPROACH IN MALAYSIAN UNIVERSITIES**

The Ministry of Education has launched the MEB (Malaysian Education Blueprint) 2015-2025 for higher education to emphasize the balance between knowledge, skills, and morality. The student aspiration in MEB is built within the six cores of the attributes; ethics & spiritually, leadership skills, national identity, language proficiency, thinking skills and knowledge (KPM, 2015).

Among the attributes, MOE highlights the leadership skills, thinking skills and knowledge as an essential component in creating the high employability skills that enable the graduates to compete with the global industry. Following the demand of the industry, the government assists the higher education institutions to develop the lifelong learning. This approach forms the graduates with potential professional skills and development of personal interests in the industry.

Within that, the Ministry constructed the education system that is less focused on traditional formal academic but prioritize technical and technologically related skills to cater students' needs and accommodate students with problem solving skills, creative and critical thinking skills and learning experience.

PBL is acknowledged as one of the pedagogical approaches that support the national aspiration aiming to deliver highly competent graduates (EPU, 2015). In recent years, the approach has become one of the effective approaches in teaching and learning settings that have gained considerable importance.

Historically, PBL was introduced in Malaysian educational landscape in the early 1970s, particularly in the health sciences (Borhan, 2012). Unfortunately, the approach has a slow growth with limited documentation of the outcomes. However, by the 1990s, medical and non-medical schools have started to use the

PBL approach in their learning practices and has been implementing the approach in variety of education fields, including engineering, information, and technology (ICT), nursing, teacher education, and architecture program (Letchumanan, 2008).

Generally, the implementation of PBL approach in Malaysian universities is more integrated into engineering and medical schools, following the other subject curricula. For example, Universiti Teknologi Malaysia (UTM) has developed the technology-based learning approach in its various engineering schools. The universities aiming to produce high-quality graduates with high attributes of professional knowledge and effective skills in communication, team working, problem-solving skills and lifelong learning (Khairiyah, Zaidatun, Jamalludin, & Syed Ahmad, 2005). Borhan (2012) mentions that Universiti Malaya (UM) has implemented the PBL approach in the Department of Chemical Engineering to provide students with analytical skills, critical and creative thinking skills, technical skills, group work and time supervision.

Faculty of Education in UM has also incorporated PBL approach in teaching subjects to equip future teachers with high competency skills and effective teaching strategies. In addition, the implementation of the PBL approach in Universiti Sains Malaysia (USM) in medical schools also equips the students with the problem-based curriculum and community oriented skills through the combination of lectures, practical, fixed learning modules and clinical clerkship and problem-solving sessions.

### **THE IMPROVEMENT OF STUDENTS' SKILL IN PBL**

The implementation of PBL in student learning has proven to give the positive impact on students' personal and social skills, through group participation and self-independent study. Masek, Yamin and Aris (2013) describe the active group participation enables students to communicate and reflect on the subject matter, while passive group participation discourages students from communicating and collaborating. Students that actively participate in group work tend to develop their communication skills, collaborative skills and also increase their level of confidence. Furthermore, students are motivated to enhance their contribution to group discussion through sharing ideas and information, deliver solutions and engage in discussions admittedly.

As PBL is an instructional learner-centered approach that empowers students to identify issues, conduct research and apply knowledge, students are responsible for conducting self-directed learning; providing the ideas and solutions towards the complex problem. Learner motivation increases when responsibility for the problem-solving process rests on the learners to seek information and share the relevant resources during the discussion (Savery, 2006; Letchumanan, 2008). Moreover, PBL session enhances students' abilities to learn through creative and critical thinking in analyzing and solving the real problem,

improving collaboration and interaction through sharing information and work productivity, as well as improving the concentration and self-motivation in independent learning.

### **ADAPTING OUTDOOR CLASSROOM IN PBL CONTEXT**

In the outdoor classroom context, the learning spaces are functioning as part of integrated learning space between indoors and the outdoors. To promote an active learning environment, the flexible and multi-use of the outdoor classroom spaces are required. Students during PBL practices need bigger spaces that can support their learning activities, as well as increase their cognitive development through focus and concentration.

Moreover, students establish their relationship between the outdoor physical environment with their social behaviour (Shamsuddin, Bahauddin & Aziz, 2012). The application of ergonomic consideration in terms of moveable furniture is essential in the outdoor classroom, as to accommodate students with diverse learning activities and to encourage comfortable group discussions and informal conversations (Oblinger, 2006).

The development of new teaching-learning methods have brought different perspectives in outdoor learning spaces in a campus environment (Abdullah, Beh, Tahir, Che Ani, & Tawil, 2011). The learning spaces become the crucial role in providing the most effective and dynamic learning environment for PBL practices. Hence, the importance of physical environment towards pedagogical approaches is important to be designed and constructed with more student-centered learning approaches. Diverse outdoor classroom with technology supports and various facilities are another significant criteria of outdoor learning spaces that not only encourage students to learn outdoors but also promote the virtual environment with support by wireless connection and electrical capabilities. The outdoor classroom could be easily transformed from a casual area to the vigorous gathering and meeting place. Oblinger (2005) describes the importance of learning space as *'An active, collaborative teaching and learning philosophy is often manifested in a different design. The outdoor spaces can either inhibit or enable different styles of teaching as well as learning practices'*.

In response to achieve the collaboration process and develop the critical and creative thinking skills in the outdoor classroom, the new learning spaces incorporate the technology and multi sensory experiences are desired. This type of outdoor classroom supports the changes of the learning activities and allow students to engage with the natural environment and create a sense of place. Moreover, an effective outdoor classroom that promotes interactions and movements supports students' active learning through group discussions and collaborative atmosphere.

As PBL approach practices students with self-directed learning, the essential aspects of the physical environment on campus outdoors must be effective in terms of varying design elements and places with pleasant environment (Ibrahim, Fadzil, & Saruwono, 2013). The informal learning spaces should also accommodate various settings that range from group learning spaces to the individual spots for privacy. The range of learning spaces will enhance students' learning performances and stimulate student-centered learning in the outdoors. Flexible outdoor classroom spaces encourage multiple learning activities to support students' personal skills in the PBL practices.

### **METHODS**

300 students from Department of Architecture and Landscape Architecture in three selected universities; UIAM, UPM and UiTM Puncak Alam were selected as target respondents for the questionnaire survey. The data were analyzed using Statistical Package for Social Science (SPSS). The open-ended questions were coded and categorized according to the significant findings of the students' perception and experience in PBL sessions.

### **ANALYSIS AND FINDINGS**

Table 1 shows the significant findings of the effectiveness PBL approach in students' learning performances, particularly in the student's skills development. The opinions were generally to identify the student's perception on the PBL practices relevant to their interest and enhance their curiosity in real career world.

**Table 1:** Significance student skills performances in PBL approach

Personal Skills Performances	Opinion	
	To allow students to provide feedback regarding the course relevant to student interest and the curiosity about the real career world	
	Course relevant to student interest	Arose curiosity on real career world
1. Interpersonal skills	<ul style="list-style-type: none"> <li>• Face real challenges</li> <li>• Develop curiosity and focus</li> </ul>	<ul style="list-style-type: none"> <li>• Gives awareness and develop knowledge</li> <li>• Students are more concerned with problem solving</li> <li>• Environmental context cultivates student's curiosity</li> <li>• Optimistic</li> </ul>
2. Communication skills	<ul style="list-style-type: none"> <li>• Able to communicate with the client to solve the issues</li> </ul>	-
3. Collaborative skills	-	<ul style="list-style-type: none"> <li>• Improve interaction among students and tutors</li> <li>• Student's involvement with local community</li> </ul>
4. Technology and technical skills	-	-
5. Critical and creative thinking skills	<ul style="list-style-type: none"> <li>• Confident and creative thinking</li> <li>• Desire to solve the issues passionately</li> </ul>	<ul style="list-style-type: none"> <li>• Develop critical thinking</li> <li>• Tendency to solve the issues</li> </ul>
6. Self – learning skills	<ul style="list-style-type: none"> <li>• Students learn and adapt new knowledge</li> <li>• Real experience as preparation in the field work</li> </ul>	<ul style="list-style-type: none"> <li>• Curiosity to manage self – learning</li> <li>• Increasing students time to develop self – centered learning</li> </ul>
7. Emotional intelligence skills	-	<ul style="list-style-type: none"> <li>• Students able to examine the issues and develop the methods</li> <li>• More practical learning</li> </ul>
8. Generic skills	<ul style="list-style-type: none"> <li>• Understand the theory through problem solving</li> <li>• Efficient learning activities improve students' experiences in real problem</li> </ul>	<ul style="list-style-type: none"> <li>• Providing initial ideas of problem solving</li> <li>• Students well prepared to become professional graduates</li> </ul>

Based on the result, Students from both departments and respective universities agreed that the PBL practices in design-based learning were relevant to their interest. It shows that PBL practices improved the personal skills and promoted life-long learning. Students were able to learn and adapted to new knowledge and had the confidence to face the real challenges. Other than that, students also agreed that they improved their communication skills, especially with the practitioners and able to solve the critical issues during the work project. In addition, the result shows that students also agreed that PBL practices increased their curiosity about the real career world. Students were more concern on the real world situations and to develop the critical thinking in problem-

solving. The students developed the practicality in designing for community demands as well as designing outdoor spaces by adapting the environment and hardscape element for users' needs.

Other than that, students improved their interaction and collaborative teamwork among peers and tutors, and active engagement with real world assignments. PBL also fostered students with social learning, that is, allowing students to create interaction and contribution in the group discussion and also boosted the confidence level in presenting views and opinions in the discussion session.

Table 2 illustrates the findings of the outdoor classroom adaptability with the PBL approach. The analysis indicated that outdoor settings provide appropriate spaces that encourage students to develop their active learning and improve the social interaction among students and tutors.

The students agreed the outdoor classroom improved students' collaborative skills. The spaces created an interesting environment for group discussions with flexible furnitures. Other than that, nature ambience engaged students with landscape elements and promoted relaxation when studying or socializing. The effective outdoor classroom also encouraged students to work collaboratively and be able to concentrate on completing the projects.

It was also clearly stated that the studio–project was more flexible in outdoor classrooms. The outdoors enabled students to learn and increase their design skills. The results stated that students tend to develop their design skills in interesting environment that allow the students to observe and developed various ideas.

Other than that, students were able to visualize the design work and be inspired by referring and adapting to surroundings that suit users' needs. Variety of spaces in the outdoors also enabled students to adapt to new learning experiences and develop critical and creative thinking on deciding the spaces that need to be designed. Lastly, applying design project in an outdoor classroom helped students to develop their restorative health and promote healing through engagement with nature and contemplation area.

**Table 2:** Effective outdoor classroom adaptability with the PBL approach

Student's perception on Outdoor Classroom	Opinion	
	To allow students to provide feedback regarding the outdoor classroom does promote collaborative and designing skills in PBL practices	
	Promote collaborative skills	Promote designing skills
1. Outdoor Classroom provides sufficient spaces for learning activities	<ul style="list-style-type: none"> <li>• Outdoor classroom creates an interesting environment for group discussions</li> <li>• Learning spaces that are informal and flexible</li> <li>• Pleasant environment engages student's connection with nature</li> <li>• Relaxing and practicality surroundings</li> </ul>	<ul style="list-style-type: none"> <li>• More relaxation in the outdoor area</li> <li>• Visual analysis in outdoor campus improves design skills</li> <li>• Connection to nature improve student design skills</li> <li>• The interesting outdoor environment allows students to observe varies ideas</li> </ul>
2. Studio project is more flexible in the outdoors	<ul style="list-style-type: none"> <li>• Experience in real situations</li> <li>• Outdoor spaces encourage students to work together</li> </ul>	<ul style="list-style-type: none"> <li>• The student gets inspired in the outdoors</li> <li>• Students inject new experience in the real world</li> </ul>
3. Students enable to learn tasks quickly	<ul style="list-style-type: none"> <li>• Improve critical thinking</li> <li>• Students have actively participated in a thorough discussion with tutors</li> <li>• Students more focused when in the outdoors</li> </ul>	<ul style="list-style-type: none"> <li>• Students develop their learning skills by referring and adapting the outdoor environment that suits the user's needs</li> <li>• Students develop their practicality in designing outdoor spaces</li> <li>• Gain knowledge of the real process of learning</li> </ul>
4. Outdoor classroom improved PBL practices in personal skills	<ul style="list-style-type: none"> <li>• Boost confident in communication</li> <li>• Enhance skills and achieve different ideas</li> <li>• Tutors as facilitator and guide students in problem-solving</li> <li>• Students improve communication skills with peers and tutors</li> </ul>	<ul style="list-style-type: none"> <li>• Improve communication skills among students and tutors</li> </ul>

## CONCLUSION

Generally, the PBL approach supports students' various learning disciplines. The approach accommodates the students with self-directed learning through improving soft skills. An outdoor classroom is seen as a relevant learning space to cater the learning needs and support the consistency of student-centered learning. Surif et al. (2013) describe that the PBL approach requires students to be 'problem-solver' and actively participate in the discussion and teamwork, as the problems require high level of personal skills performances. The study has shown that the outdoor classroom affects students' physical and psychological development. Through providing various learning spaces and adequate outdoor facilities to support students' learning needs, the outdoors improve students' learning experiences.



In order to improve the students' learning performances, the study suggests for the outdoor learning spaces to emphasize the areas suitable for tertiary level. This include providing the sufficient spaces for learning activities, flexible area for studio project and group assignment, spaces with suitable accommodation and excellent facilities including technology and technical appliances as well as the outdoor area that can improve the students' psychological behavior.

The outdoor classroom in campus is also designed to support the visual, nature and image enhancement for the institutions.

## **ACKNOWLEDGEMENT**

This work was supported by International Islamic University Malaysia.

## **REFERENCES**

- Abdullah, N. A. G., Beh, S. C., Tahir, M. M., Che Ani, A. I., & Tawil, N. M. (2011). Architecture design studio culture and learning spaces: A holistic approach to the design and planning of learning facilities. *Procedia - Social and Behavioral Sciences*, 15, 27-32.
- Borhan, M. T., (2012). Problem based learning (PBL) in Malaysian higher education: A review of research on learners experience and issues of implementations. *ASEAN Journal of Engineering Education*, 1(11), 48-53.
- Economic Planning Unit [EPU] (2015). *Eleventh Malaysian Plan*. Retrieved from <http://epu.gov.my/en/rmk/eleventh-malaysia-plan-2016-2020>
- Graaff, E. D. E. & Kolmos, A. (2003). Characteristics of problem-based learning. *International Journal of Engineering Education*, 19(5), 657-662.
- Goodman, R. J. B. (2010). Problem-based learning: Merging of economics and mathematics. *Journal of Economics and Finance*. 34(4), 477-483.
- Ibrahim, N., Fadzil, N. H., & Saruwono, M. (2013). Learning outside classrooms on campus ground: Malaysia. *Asian Journal of Environment-Behaviour Studies*, 4(13), 97-110.
- Khairiyah, M. Y., Zaidatun, T., Jamalludin, H., & Syed Ahmad, H. (2005). Promoting problem-based learning (PBL) in engineering courses at the Universiti Teknologi Malaysia. *Global Journal of Engineering Education*, 9(2), 175-184.
- Letchumanan, M. (2008). Problem Based Learning in Mathematics. *Research Bulletin of Institute for Mathematical Research*, 21-25.
- Masek, A., Yamin, S., & Aris, R. (2013, July). Students participation and facilitation in PBL tutorial session. *4th International Research Symposium on Problem Based Learning (IRSPBL 2013)*. July 2-3, 2013, Putrajaya, Malaysia.
- Ministry of Education Malaysia [KPM] (2015). *Malaysia Education Blueprint 2015-2025* (Higher Education).

*Maheran Yaman, Fadzidah Abdullah, Nur Fadhilah Rozali, & Farha Salim*  
*The Relevancy of Outdoor Classroom for PBL Approach in Selected University in Kuala Lumpur*

- Oblinger, D. G. (2006). Learning spaces. *British Journal of Educational Technology*, 41.
- Oblinger, D. (2005). Leading the transition from classrooms to learning spaces. *EDUCAUSE Quarterly*, 28(1), 14-18.
- Savery, J. (2006). Overview of problem-based learning: Definitions and distinctions. *Interdisciplinary Journal of Problem Based Learning*, 1(1), 269-282.
- Shamsuddin, S., Bahauddin, H., & Aziz, N. A. (2012). The relationship between the outdoor physical environment and students' social behavior in urban secondary school. *Procedia-Social and Behavioral Sciences*, 50, 148-160.
- Surif, J., Ibrahim, H., & Mokhtar, M. (2013, July). Implementation of problem based learning in higher education institutions and its impact on students' learning. *4th International Research Symposium on Problem Based Learning (IRSPBL 2013)*. July 2-3, 2013, Putrajaya, Malaysia.



**THE MEDIATING EFFECTS OF AWARENESS ON THE  
RELATIONSHIP BETWEEN PROCUREMENT MANUAL  
COMPLIANCE'S BARRIERS AND COST PERFORMANCE OF  
CONSTRUCTION PROJECTS**

**Abdullahi Nafiu Zadawa<sup>1</sup>, Abdul Aziz Hussin<sup>2</sup> & Atasya Osmadi<sup>3</sup>**

*<sup>1</sup>School of Environmental Technology*  
ABUBAKAR TAFAWA BALEWA UNIVERSITY NIGERIA

*<sup>2,3</sup>School of Housing Building and Planning*  
UNIVERSITI SAINS MALAYSIA

**Abstract**

Public Procurement Manual (PPM) are the procedural guidelines for executing public procurement practices including construction procurement. Compliance with PPM among construction procurement parties has been facing serious challenges which affects the performance of construction projects especially cost aspect. This study identified fraudulent practices as the major procurement manual compliances' barriers affecting cost performance of construction projects. The paper examines the mediating effects of awareness on procurement manual compliance's barriers affecting cost performance. Data was collected from the procurement entities of nine selected Nigerian federal universities. A mediation analysis was performed via bias-corrected bootstrapped confidence interval approach using Process Macro package. The indirect effects obtained was positive and different from zero, and the confidence interval within which the effect occur do not include zero indicating that awareness can mitigate the effects of fraudulent practices been compliance barriers affecting cost performance of construction projects.

**Keywords:** awareness, public procurement manual, non-compliance, cost performance

## **INTRODUCTION**

Public procurement manuals (PPM) are the procedural guidelines for executing procurement of major infrastructural facilities, construction of building projects, supply of goods and services by the public entities. The manuals are meant to ensure the attainment of principles of public procurement mainly accountability, transparency, competition, and fairness among tendering bidders. In most developing countries procurement manuals are highlighted within the public procurement policies. Most of the country's procurement policies are the dividends of public reforms initiatives for sustainable development of infrastructural facilities (Williams-Elegbe, 2013). Despite the expected role played by the procurement manual in regulating public procurement conducts, compliance with the manual among construction procurement stakeholders and project parties have been facing serious snags (Jibrin, Ejura, & Augustine, 2014).

Gelderman, Ghijsen and Brugman (2006) reported issues of non-compliance with the European Union (EU) tendering and procurement directives. Among OECD member countries, application of procurement proceedings remained seldom in certain economic sectors (OECD, 2007). In Malaysia, an interview with contractors revealed cases with inappropriate application of procurement manuals (Hui, Radiah, Normah, Rashidah, & Nurul, 2011). In Nigeria, indications of selective implementation and non-compliance with PPM is evidenced in most economic sectors of the country (Ojo & Gbadebo, 2014). In the construction industry in particular, one of the major barriers to compliance with the PPM is fraudulent practices especially at the pre-construction contract stages (Wells, 2013; Shehu, 2014). In order to further understand these literature arguments, this paper attempts to explore the situations under which compliance with PPM will reduce the negative effects of fraudulent practices affecting cost performance of construction projects. This paper examines the mediating effects of awareness on the relationship between PPM non-compliance barriers and cost performance of construction projects.

## **LITERATURE REVIEW**

This section of the paper presents a review of the literature on the study variables which leads to hypothesis development aimed at examining a mediation-based causal relationship of awareness on procurement manual compliance barriers that affect cost performance. A hypothetical mediation framework of the study is also presented at the tail of this section.

### **Public Procurement Manual and Related Compliance Issues**

Public procurement manuals (PPM) are the regulatory procedural guidelines for executing construction contracts and a host of other public procurement practices. Construction procurement as the major activities of the construction industry is a

sub-element of public procurement which contributes immensely to the development of every nation (Inuwa & Diang'a, 2015; Abdullahi, Hussin, & Osmadi, 2015). In most developing countries and especially in Nigeria, the PPM plays a vital role in ensuring the delivery of construction projects based on the specification, time and financial budget (Ojo & Gbadebo, 2014; Shehu, 2014). Globally non-compliance to procurement directives seems to be an issue. Previous studies that attempted to investigate compliance with procurement manuals' issues are delimited to the provision of compliance factors that determines construction project cost performances. Yet from the construction industry perspective, compliance with the PPM among major procurement stakeholders and projects parties are facing serious challenges (Ojo & Gbadebo, 2014; Abdullahi, Hussin, & Osmadi, 2017). Fraudulent practices especially at pre-contract and tendering stages are one of the barriers to compliance with PPM among stakeholders (Wells, 2013; Shehu, 2014). This study identified fraudulent practices factors in construction procurement as the major barriers to the compliance with PPM, hence it is the main dimension of the independent variable of the study. The cost performance of construction projects is the dependent variable.

*H<sub>1</sub>: Public Procurement Manual Compliance's Barriers affects Cost Performance of Construction Projects.*

### **The Mediating Effects of Awareness**

Awareness is the mediating variable of the study. Awareness is hypothesized to mitigate the effects of the relationship between PPM compliance's barriers (fraudulent practices) and cost performance of construction projects. Lack of awareness has created a wide void in the race towards reforming public procurement sector, thus providing appropriate knowledge through training and enlightening the procurement stakeholders would be an effective tool (Gelderman et. al., 2006). Findings of prior studies indicated that compliance with procurement manual is influenced directly by the level of familiarity among the stakeholders, and realistic level of familiarity is achieved with sufficient awareness (Boer & Telgen, 1998; Lazarides, 2011). Mbaya (2013) also maintained that advancing the level of awareness will be the most effective tool to appropriately educate procurement stakeholders, professional and other relevant construction project parties towards improving compliance. In their studies, Hui et al. (2011) also recommended awareness as an ultimate remedy to non-compliance among construction project parties. Sang and Mugambi (2014) also affirmed that awareness is the most significant compliance factor compared to other compliance measurement items.

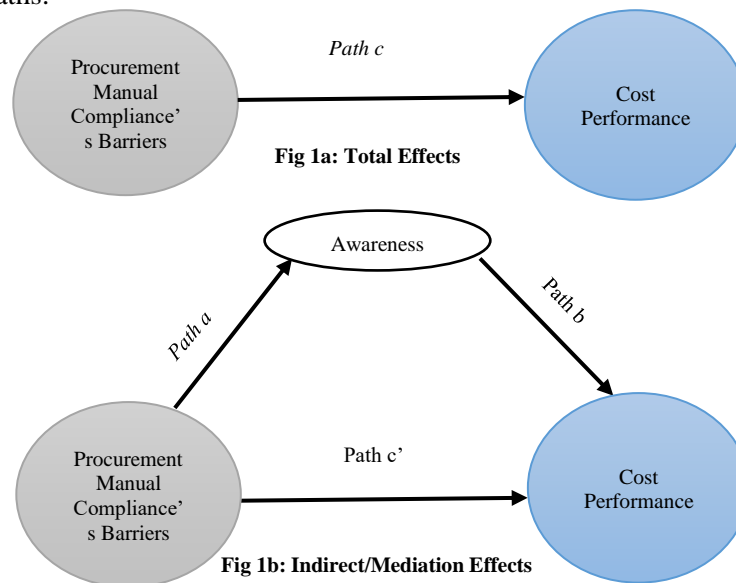
*H2: Awareness mediates the effects of the relationship between Public Procurement Manual compliance barriers and cost performance of construction projects.*

### Construction Project Cost Performance

Cost is one of the most sensitive core elements that determine the overall performance of construction projects (Akinsiku & Iyagba, 2014). The role played by cost in construction project procurements runs through the entire project management life cycle (Azhar, Farooqui, & Ahmed, 2008; Othman, Zakaria, Nordin, Shahidan, & Jusoff 2010). Therefore, projects executed within appropriate budget is said to satisfy the basic performance requirement; thus it fulfills the client's need of good value for money and achieve technical performance based on specification (Frimpong, Oluwoye, & Crawford, 2003). Hitherto, cost performance aspect of construction projects remains one of the major challenge of the construction industry. Inadequate knowledge of the procurement manual due to lack of awareness is considered as a foremost cause (Abdullahi et. al., 2017; Akinsiku & Iyagba, 2014).

### Conceptual Mediation Framework of the Study

Figure 1 below presents the conceptual mediation framework of the study; figure 1a shows the total effects path, while figure 1b shows the indirect/mediation effects paths.



**Figure 1: Conceptual Mediation Framework of the Study**

## RESEARCH METHODS

The study uses quantitative strategy to examine the mediation effects of awareness between public procurement guidelines compliance barriers and cost performance of construction projects. Quantitative research strategy allows the variables to be tested with the help of theories so that an appropriate outcome can be obtained (Sekaran & Bougie, 2016). The study populations are construction project parties attached to the federal universities in Nigeria, mainly the project client, project managers, professional consultants, and contractor. Stratified proportionate random sampling was used in selecting adequate number of sample. The study was limited to twenty-two federal universities across the northern Nigeria, with a total of 1870 active procurement stakeholders and construction project parties. Nine (9) universities were randomly selected out of which 320 respondents were selected based on Krejcie and Morgan (1970) sampling technique as cited in Sekaran & Bougie, (2016). The structured survey questionnaire was the main instrument used in collecting data. It was designed and tested for validity and reliability (Sakaran & Bougie, 2016). All the items were measured with 5-point Likert scale; 1 for strongly disagree and 5 for strongly agree. The Likert scale has the proficiency to ensure all items and factors measured the same thing (Cornalba & Giudici, 2004). 540 questionnaires were distributed randomly to the targeted respondents Only 410 copies were retrieved, 31 were rejected, and the remaining 379 useable questionnaires were analyzed, implying a 70% and 76% response rate and return rates respectively.

## RESULTS PRESENTATION

Mediation analysis was performed based on Bias-corrected bootstrapping confidence interval approach using Process Macro developed by Hayes (2012). Bootstrapping methods are non-parametric based statistics that perform mediation analysis by the means of resampling and replacement. In particular, bias-corrected bootstrapped confidence interval method has an advantage of high statistical power and it does not rely on normal theory assumption (Preacher & Hayes, 2008).

### **Effects of Compliance's Barriers on Awareness (path a)**

Coefficient of determination along *path a* obtained was 1.4511, t-value was 84.2227, while p-value was 0.0000 significant ( $p < 0.05$ ) at 95% confidence interval. The lower and upper levels confidence intervals (i.e. LLCI and ULCI) were 1.3919 and 1.5103 respectively as presented in table 1 below. Thus, p-value obtained ( $p < 0.05$ ) and the LLCI and ULCI (which do not include zero) indicated statistical significant relationship along *path-a* based on bootstrapped confidence interval mediation requirements (Hayes, 2013; Williams-Elegbe, 2013).

### Effects of the Relationship along path b and path c'

Table 1 also presents the coefficient of determination along both *path b* and *path c'*. The effects of awareness on cost performance (*path b*) had a coefficient of 0.2755, t-value is 17.9927, while p-value is 0.0000 ( $p < 0.05$ ) which is significant at 95% bias corrected bootstrapped confidence interval. The ULCI and LLCI along *path b* were 0.2454 and 0.3056 respectively, path b is also significant since there was no zero value between the confidence interval and p-value  $< 0.05$  at 95 (Hayes, 2013; Zhao et. al., 2010). Path *c'* had a coefficient of -0.0526, t-value was -1.4673 and p-value was 0.1431 insignificance ( $p > 0.05$ ) at 95% bias-corrected bootstrapped confidence interval. The ULCI and LLCI were -0.1232 and 0.0178 respectively. Hence, the p-value was not significant and zero (0) value was included within the ULCI and LLCI indicating insignificant effects along *path c'* (Hayes, 2013; Zhao, Lynch, & Chen, 2010).

### Total Effects of Compliance Barriers on Cost Performance (path c)

Coefficient of determination of the total effects path (*path c*) was 0.3730, t-value was 23.3569 while p-value was 0.0000 significant ( $p < 0.05$ ). The ULCI and LLCI were 0.3416 and 0.4044 respectively which obviously did not include zero within the range indicating statistical significant effects along *path c* based on bias-corrected bootstrapped confidence interval mediation principles (Hayes, 2013; Zhao et. al., 2010).

**Table 1:** Summary of the Mediation Results along various Paths

Variables Linkages	Coeff. of Determination	P-Values	LLCI & ULCI	Path	Remark
Comple's bar. to Awareness	1.4511	0.0000	1.3919, 1.5103	<i>Path a</i>	Sig
Awareness. to CstPerf	0.2755	0.0000	0.2454, 0.3056	<i>Path b</i>	Sig
Comple's bar. to CstPerf via Awareness	-0.0526	0.1431	-0.1232, 0.0179	<i>Path c'</i>	In sig.
Comple's bar. to CstPerf	0.3730	0.0000	0.3416, 0.4044	<i>Path c</i>	Sig

## DISCUSSION

In accordance with bias-corrected bootstrapped confidence interval method, the mediation effect was evaluated based on the indirect effects' paths (i.e. path a & path b) as recommended by Hayes, Preacher and Myers, (2011). This approach mainly for the contemporary mediation methods such as bootstrapping was



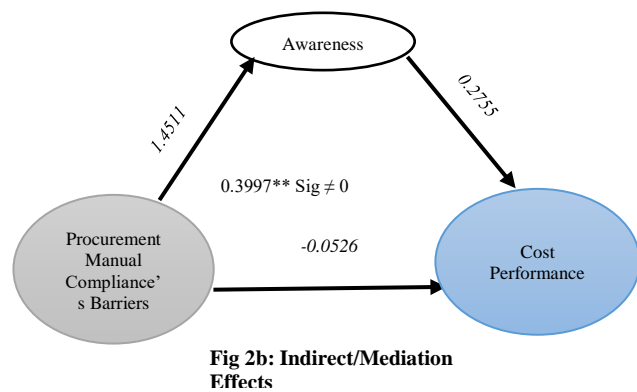
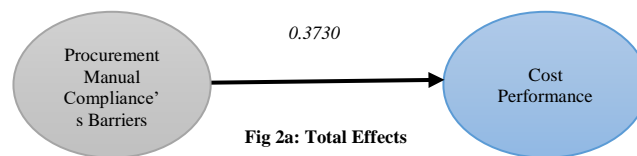
introduced to overcome the weakness of the famous Baron and Kenny (1986) causal step mediation approach.

Mathematically, the indirect effect is the product of the indirect effect path's coefficients

$$\text{i.e. (path } a * \text{path } b)$$

$$1.4511 * 0.2755 = 0.3997$$

The indirect effects (0.3997), which was estimated based on the coefficients of the determination of the effects of PPM compliance's barriers on awareness (*i.e. path a = 0.2755*) as well as that of *path b = 0.3997* which was the effects of awareness on cost performance of construction projects. As shown the indirect effects (0.3997) was positive and totally different from zero, thus indicating the occurrence of mediation in the hypothesis framework of the study as suggested by Hayes, (2012), Hayes, (2009) as well as MacKinnon, Lockwood and Williams (2004). Therefore, the findings signified that awareness mitigated the negative effects of the barriers to compliance with public procurement manual (mainly fraudulent practices) on cost performance of construction projects. Figure 2 shows the final derived mediation-based framework of the study indicating coefficients of determinations along the various paths.



**Figure 2:** Derived mediation framework of the study

### CONCLUSION & RECOMMENDATION

This study aims to examine the mediating effects of awareness on the relationship between PPM compliance barriers and cost performance of construction projects.

Data was collected from procurement entities of Nigerian federal universities, analysis was performed through bias-corrected bootstrapped confidence interval mediation approach using Process Macro. The indirect effects obtained which determines the occurrence of the mediation effects was positive and different from zero, also the bias-corrected confidence interval within which the indirect or mediation effects occur do not include zero. This signifies that, awareness proposed as a mediating variable will mitigate the large negative effects of PPM compliance barriers (fraudulent practices) on cost performance of construction projects. These findings conform to Kisang and Kwasira (2005), and Onyinkwa (2013). The study has contributed to the body of knowledge to the practices of construction project procurement. The study recommends that procurement entities should widen the level of awareness on the appropriate application of public procurement manual in order to improve compliance among major stakeholders and construction project parties.

## REFERENCES

- Abdullahi, N. Z., Hussin, A. A., & Osmadi, A. (2015). Determinants of compliance with public procurement guidelines in the Nigerian construction industry. *Jurnal Teknologi*, 75(9), 107-110.
- Abdullahi, N. Z., Hussin, A. A., & Osmadi, A. (2017). Mediation effects of innovative procurement practices between the determinants of non-compliance with public procurement guidelines and construction project cost performance in the Nigerian construction industry. *Transactions on Ecology and the Environment*, 210, 99-109.
- Akinsiku, O. E. & Iyagba, O. A. (2014). Cost and time performance of construction projects: A comparative study of southern Peninsular Malaysia and Lagos, Nigeria. *Journal of Education Research*, 2(2), 75-82.
- Azhar, N., Farooqui, R. U. & Ahmed, S.M. (2008, August). Cost overrun factors in construction industry of Pakistan. *1<sup>st</sup> International Conference on Construction In Developing Countries (ICCIDC-I)*. August 4-5, 2008, Karachi, Pakistan.
- Boer, L. & Telgen, J. (1998). Purchasing practice in Dutch municipalities. *International Journal of Purchasing and Materials Management*, 34(1), 31-36.
- Baron, R. M. & Kenny, D. A. (1986). The moderator-mediator variable distinction in social psychological research: Conceptual, strategic, and statistical considerations. *Journal of Personality and Social Psychology*, 51(6), 1173.
- Cornalba, C. & Giudici, P. (2004). Statistical models for operational risk management. *Physica A: Statistical Mechanics and Its Applications*, 338(1), 166-172.
- Frimpong, Y., Oluwoye, J., & Crawford, L. (2003). Causes of delay and cost overruns in construction of groundwater projects in a developing countries; Ghana as a case study. *International Journal of Project Management*, 21(5), 321-326.
- Gelderman, C. J., Ghijsen, P. W. T., & Brugman, M. J. (2006). Public procurement and EU tendering directives-explaining non-compliance. *International Journal of*

*Public Sector Management*, 19(7), 702-714.

- Hui, S. W., Radiah, O., Normah, H. O., Rashidah, A. R., & Nurul, H. H. (2011). Procurement issues in Malaysia. *International Journal of Public Sector Management*, 24(6), 567-593.
- Hayes, A. F. (2012). PROCESS: A versatile computational tool for observed variable mediation, moderation, and conditional process modeling [White paper]. Retrieved from <http://imaging.mrc-cbu.cam.ac.uk/statswiki/FAQ/SobelTest>
- Hayes, A. F. (2013). *Introduction to mediation, moderation, and conditional process analysis: A regression-based approach*. New York: Guilford Press.
- Hayes, A. F., Preacher, K. J., & Myers, T. A. (2011). Mediation and the estimation of indirect effects in political communication research. In E. Bucy & R. Holbert (Eds.), *Sourcebook for political communication research: Methods, measures, and analytical techniques* (pp. 434-465). London: Routledge.
- Hayes, A. F. (2009). Beyond Baron and Kenny: Statistical mediation analysis in the new millennium. *Communication Monographs*, 76(4), 408-420.
- Inuwa, I. I. & Diang'a, S. (2015). Effective procurement practices in a developing economy for sustainable construction. *Journal of Environmental Technology*, 8(2), 64-78.
- Jibrin, M. S., Ejura, S. B., & Augustine, N. I. (2014). The public procurement reforms in Nigeria: Implementation and compliance challenges. *Journal of Asian Business Strategy*, 4(11), 149-162.
- Krejcie, R. V. & Morgan, D. W. (1970). Determining sample size for research activities. *Educational and Psychological Measurement*, 30(3), 607-610.
- Kisang, L. & Kwasira, J. (2015). Assessment of Success Factors for Implementation of Public Procurement and Disposal act in the County Government of Uasin Gishu, Kenya. *International Journal of Economics, Commerce and Management*, 3(11), 513-527.
- Lazarides, T. (2011). Corporate governance legal and regulatory framework's effectiveness in Greece: A response. *Journal of Financial Regulation and Compliance*, 19(3), 244-253.
- Mbaya, P. M. (2013). *Factors influencing compliance with the public procurement legislation in Kenya* (Master thesis). University of Nairobi, Nairobi, Kenya.
- MacKinnon, D. P., Lockwood, C. M., & Williams, J. (2004). Confidence limits for the indirect effect: Distribution of the product and resampling methods. *Multivariate Behavioral Research*, 39(1), 99-128.
- Othman, R., Zakaria, H., Nordin, N., Shahidan, Z., & Jusoff, K. (2010). The Malaysian public procurement's prevalent system and its weaknesses. *American Journal Of Economics And Business Administration*, 2(1), 6-11.
- OECD (2007). *Bribery in public procurement methods: Actors & counter-measures*. Massachusetts, USA: OECD Publishing.

- Ojo, E. & Gbadebo, A. (2014). An assessment of non-compliance with procurement proceedings in procurement of works in Nigeria. *International Journal of Economic and Business Management*, 2(3):25-34.
- Onyinkwa, J. (2013). Factors influencing compliance to procurement regulations in public secondary schools in Kenya: A case of Nyamache District, Kisumu County. *Interdisciplinary Journal of Contemporary Research in Business*, 5(1), 561.
- Preacher, K. J. & Hayes, A. F. (2008). Asymptotic and resampling strategies for assessing and comparing indirect effects in multiple mediator models. *Behavior Research Methods*, 40(3), 879-891.
- Shehu, A. S. (2014, June). An overview of public procurement guidelines in Nigeria. *Institute of Quantity Surveyors National Seminar 'Procurement of Construction Works and Services – Adapting to Contemporary Challenges'*. June 11-12, 2014, Gombe, Nigeria.
- Sang, W. K. & Mugambi, F. (2014). Factors affecting compliance with public procurement laws and regulations in public institutions in Kenya: A case study on public entities in Mombasa County. *International Journal of Social Sciences and Entrepreneurship*, 1(11), 650-671.
- Sekaran, U. & Bougie, R. (2016). *Research method for business: A skill building approach* (7<sup>th</sup> edition). New York: Wiley.
- Williams-Elegbe, S. (2013). The World Bank's influence on procurement reform in Africa. *African Journal of International and Comparative Law*, 21(1), 95-119.
- Wells, J. (2013). Corruption and collusion in construction: a view from the industry. In T. Soreide & A. Williams (Eds.), *Corruption, grabbing and development: Real world challenges* (pp. 23-34). Cheltenham: Edward Elgar.
- Zhao, X., Lynch, J. G., & Chen, Q. (2010). Reconsidering Baron and Kenny: Myths and truths about mediation analysis. *Journal of Consumer Research*, 37(2), 197-206.



## **FACTORS INFLUENCING PARENTS IN SELECTING SCHOOL FOR CHILDREN WITH SPECIAL EDUCATION NEEDS**

**Muhammad Faris Abdullah<sup>1</sup>, Ainul Ashiqin Ahmad Shuhaimi<sup>2</sup>, Mariana Mohamed Osman<sup>3</sup>, & Noor Suzilawati Rabe<sup>4</sup>**

<sup>1,2,3,4</sup>*Kulliyyah of Architecture and Environmental Design,*  
INTERNATIONAL ISLAMIC UNIVERSITY MALAYSIA

### **Abstract**

Equal access to education is an essential element in achieving community well-being, hence it is crucial that the educational facilities to be equally accessible to children with special education needs. In Malaysia, one of the special education programme provided in mainstream public schools is the Program Pendidikan Khas Integrasi (PPKI). The programme is an effort towards inclusive education. The objective of this study includes: (i) to analyse the factors influencing the decision of parents in selecting school for their special children, and (ii) to assess the issues and problems faced by parents in selecting schools for their children with special needs. The study determines parents' criteria in selecting school for their children with SEN among 134 parents of children in PPKI via questionnaire survey. Semi-structured interview was conducted among 12 teachers of PPKI, and the findings from the interview were used to validate the survey findings. Findings from these two methods were consolidated. Result shows that school selection for children with special needs are greatly associated with the school facility. The paper will benefit the local authority in planning for educational facility, as well as special needs children with regards to the educational facility for special education provision in a community.

**Keywords:** special education, educational facilities, factors, parental influence, Special Education Integrated Programmes

<sup>1</sup>Assistant Professor at International Islamic University Malaysia. Email: mfaris@iium.edu.my

## **INTRODUCTION**

The Malaysian education system aims to be more accessible and comprehensive especially for children with special education needs. These children have the rights to formal education just like every other children. According to the Special Education Regulations 2013, special education is an education programme that is either provided in special schools or in mainstream schools with special education integrated programme/ *Program Pendidikan Khas Integrasi* (PPKI) or inclusive programmes at different levels such as preschools, primary, secondary and the higher secondary.

Special education programme is designed to meet the needs and learning capacity of people with disability - those with visual impairment, hearing impairment, speech difficulties, physical disabilities, multiple disabilities and learning disabilities such as autism, Down syndrome, attention deficit hyperactivity disorder, and dyslexia, all which restricts their full participation in the society. Pupils with special education needs require additional support in overcoming their challenges in self-development. The challenges faced by these pupils should explain the rationale behind parents' preferences in selecting schools for their children. The objective of this study includes: (i) to analyse the factors influencing parents' decision in selecting school for their special needs children, and (ii) to assess the issues faced by parents in selecting schools for their special needs children.

## **SPECIAL EDUCATION**

It is the responsibility of the Ministry of Education (MOE) to provide access to education for all children including those with special education needs. The Education Act 1996 requires the MOE to provide special education in special schools or in designated primary and secondary schools, as an integrated or inclusive programmes. The special education regulation is applicable in government schools and in government-aided schools with special education programmes.

There are three types of special education settings identified in the Malaysian education system which are special schools, integrated programmes and inclusive programmes. An integrated program, forms part of the mainstream school, is aimed at maximizing the social interaction between pupils with special education needs and their mainstream peers (Nordin, 2001). On the other hand, inclusive special education program allows pupils with special education needs to be included and to receive instructions within a mainstream class which is proven to have positive results as concluded by several researches (Ali, Ramlee, & Jelas, 2006). Identifying different categories of special needs allows schools to recognize the education programmes that suits the special children's needs. This study however only focuses on the special education integrated programme or known as PPKI.

According to the MOE's Manual Operation for PPKI, great considerations are taken into account before operating PPKI in schools that includes the parents' or guardian's application, pupil projections, the needs for Special Education teacher, physical infrastructure of classrooms, equipment and teaching materials.

Pupils with special education needs commonly require easy accessibility and barrier-free environment in the school area to ease their movements and wayfinding within the school compound. Supporting school facilities such as the library, computer laboratory, music room among others should be equally accessible. Accessible school facility should be a priority even though the number of pupils with special education needs is significantly less in comparison to the number of normal mainstream pupils. However, it is noted that the recorded number of special education pupils has been increasing over the years (Jelas & Ali, 2014).

### **SCHOOL CRITERIA**

School choice is the right to express a preference for specific schools (Burgees, Greaves, Vignoles, & Wilson, 2014). Parents' satisfaction is a rather subjective factor in the decision making, because it is the overall considerations of all criteria upon taking into account all the possible pros and cons of available options (ISCA, 2008).

The ideal school distance is stipulated in the planning and design guidelines for educational facilities published by the Federal Department of Town and Country Planning Peninsular Malaysia. The school location and the school distance are significantly related in determining the home to school travelling mode (Adepoju & Oluchukwu, 2011; Yusuf & Adigun, 2010; Ibrahim, Osman, & Bachok, 2014). Despite the school distance influencing the mode of transport, route safety remains the top concern in deciding the mode of transport (Lee, Zhu, Yoon, & Varni, 2013). Regrettably, children with special education needs may require to travel further than those of mainstream programmes due to the limited number of schools that suits their particular education needs (Easton & Ferrari, 2015). Some of these special pupils are prone to greater risk of injuries and fatality in the event of an accident (Graham, Keys, McMahon, & Brubacher 2014).

Previous studies show that the school location is one of the top most important factor that is also a variable that affects the pupils' academic performance (Adepoju & Oluchukwu, 2011; Bukhari, Rodzi, & Noordin, 2010). In general, there are other factors that may influence pupils' academic performance. A study done in the US on educational placement shows that schools in urban districts tend to have higher enrollment rate that influences the time spend in general education (Brock & Schaefer, 2015). In the case of those with special needs, their overall performance may be greatly influenced by

anxiety, lack of self-confidence, negative self-concept, personal inadequacy and maladjustments (Adeyemi, 2011). In consideration of these factors, parents tend to less emphasize on the academic performance of their special children.

Since not every pupils are ready to start on academic work at a young age, a special environment is recommended for the children with special needs that provides them special curriculum that suits their social and vocational needs (Rahaman, 2014; Schneider, 2003; Bhattacharya, 2016). The key to effective libraries and facilities is to include the involvement of teachers with special education backgrounds (Abrizah & Ahmad, 2010).

Other than specialized academic materials, pupils with different disabilities may require physical assistance such as ramps, handrail, signage and many more. Educational facilities should provide a safe and secure environment for all pupils especially for the special need pupils where every parent is confident in allowing their child to live independently (Rahaman, 2014). Educational facility should be able to provide sufficient resources (Abrizah & Ahmad, 2010), for example, school spaces and environment need to be safe and secure for both the pupils and the teachers, so as to feel calm, motivated, active and confident to move around.

The appropriate ratio for teachers in integrated special education programmes should be 1.5 teachers to 6.5 pupils or maximum of seven (7) pupils per class. Small group learning is found to be more conducive, secure and tolerant of special pupils (Meynert, 2014). Large classes may discourage involvement, provides opportunities for social lazing with pupils playing a less active role in the learning process (Leufer, 2007).

Parental income greatly affects the parents' ability to support their child in their educational pursuit (Coelli, 2011; Huang, Guo, Kim, & Sherraden 2010). The paternal and the maternal income do however have different influence on the child's education costs (Dunn, Cole, & Estrada, 2009).

## **METHODOLOGY**

The factors addressed in this paper was based on literature reviews. The reviews serve as a purpose to indicate and discuss significant issues and to justify findings in the attempt to explain and support the findings from a questionnaire survey as data-collection method. In relation to this study, literature review acts as an important tool involving readings from numerous important materials gathered from, journals, public papers and media on issues relating to school selection.

The factors included in the questionnaire are made into a simple and clear form that would ease the respondents in answering the questionnaire survey. For this study in particular, the targeted respondents are the parents of children with special education needs that are enrolled into PPKI. Data collected is analysed using the RII.



The primary data collection involves questionnaire survey in order to obtain information in regards to the study. The questionnaire consists of five main sections:

- i. Section A: Parent's Background
- ii. Section B: Child's Background
- iii. Section C: Access to Special Education Facilities
- iv. Section D: Parents' School Criteria
- v. Section E: Issues on Special Education Programmes

However, this paper solely focus on the school criteria as well as the issues surrounding the special education programme. The data collection stage was conducted within a 3 months period, from Mac 2016 to June 2016. A total of 300 questionnaires were distributed among parents in Gombak district within the data collection period. However, only a total of 134 questionnaires were returned with complete answers.

Then, semi-structured interviews with 12 PPKI teachers as the key informants were conducted to validate the survey data. Teachers were among PPKI vice-principals and class teachers, the key informants were asked to rank the criteria of parental preferences based on their experiences. Later in the interview questions, key informants were enquired to summarise arising issues in regard to the current special education programme.

## **FINDINGS**

Seven criterias were identified and applied into the study. Parents were asked to rank these criteria according to their preferences, concerning their children with special needs. The seven criteria are (i) location, (ii) distance, (iii) school environment, (iv) school facilities, (v) teacher-pupil ratio, (vi) academic performance and (vii) education cost. Respondents were asked to rank one (1) as the most important criteria until seven (7) as the least important criteria.

RII was calculated to analyse the responses. The RII is a method that determines the relative importance of the factors of preference in decision-making in selecting school.

**Table 1** School Criteria from Survey

Criteria	Score	RII	Rank
School Facility	635	0.677	1
School Environment	612	0.652	2
School Distance	595	0.634	3
Academic Performance	580	0.618	4
School Location	556	0.593	5
Teacher-Pupil Ratio	403	0.430	6
Education Cost	370	0.394	7

*Source: Primary Data (2016)*

Based on the findings, the school facility was chosen as the most important criteria for parents in selecting school to enrol their special children, with the RII scores of 0.677 which has been stated in the Table.1. This is followed by the school environment with RII scores of 0.652, school distance with RII score of 0.634, academic performance with RII scores of 0.618, school location with RII scores of 0.593 and teacher-pupil ratio with RII scores of 0.430. The education cost ranked as the least importance criteria in school selection with the lowest RII scores of 0.394.

**Table 2** School Criteria from 12 Key Informants

Criteria	Score	RII	Rank
School Facility	65	0.774	1
School Location	61	0.726	2
School Distance	58	0.690	3
School Environment	50	0.595	4
Teacher-Pupil Ratio	42	0.500	5
Academic Performance	41	0.488	6
Education Cost	19	0.226	7

*Source: Primary Data (2016)*

Table 2 shows the findings of the semi structured interviews, the school facility was chosen as the most preferred criteria for parents in choosing a school to enrol their special children, with the RII scores of 0.774. This is followed by the school location with RII scores of 0.726, school distance with RII score of 0.690, school environment with RII scores of 0.595, teacher-pupil ratio with RII scores of 0.500 and academic performance with RII scores of 0.488. The education cost ranked as the least importance criteria in school selection with the lowest RII scores of 0.226.

In the final section of the questionnaire survey, parents and key informants were enquire if there were issues encountered in selecting school and other arising issue in regards to the special education programme. The common problems faced by parents includes (i) that there are limited number of schools that cater to children with special needs, and (ii) some of the parents had to consider and be referred to several schools before registering their children into a school.

From the perspective of the key informants, the common issues in regards to the special education programmes includes (i) the limited number of schools offering suitable PPKI programmes, (ii) the school distance is further than the desirable distance, (iii) the number or the size of the facilities have not been improved to meet the population, other issues include the difficulty in standardizing the pupils' teaching and learning methodology due to their different needs and challenges and that the variance of development modules are limited.

## **DISCUSSION**

The research aims to determine parents' criteria in selecting public schools with PPKI that suits their children's special needs. The findings from the interview are used to validate the survey's findings. There are two main objectives to this study, the first is to analyse the factors influencing the decision of parents in selecting school for their special children. A conclusion drawn based on the findings is that the school facility is top most influential factor in selecting school for children with special education needs. Parents prefer schools with suitable and good facility provision that is able to support their special need children. The school facility has a significant effect on the pupils' performance, which explains parents' preference.

The school facility is positively correlated with the pupils' performance according to several studies. Adequate infrastructure and facilities becomes the basic need for the development of children with special needs. It has been discussed that pupils with special education needs prefers to engage their senses for better focus and learning capacity. One form of facility provision may be suitable for average child, but may be unfit for children with special needs. The PPKI aims to educate these special pupils into developing basic set of skills such as self-management skills, communication skills, cooking skills to name a few. As a mean of support to develop these skills, proper and well equipped facility should be provided.

In addition, a conducive school environment which is a reflection of a good school facility is the second top most important criteria for parents. The school environment includes the overall conducive learning and teaching as well as a safe and secure surrounding. When most parents consider the school facility to be the most important factor in selecting school for their special children, parents are willing to travel at a greater distance if the chosen school provides better school facilities. Primary schools should be within 800m radius from home while secondary schools should be within 1.6km radius. However, it is difficult for PPKI schools to meet this stipulated buffer zone due to the fact that identifying new PPKI schools are not as specified as public mainstream schools. The setting for special education programmes are not pre planned like the public schools. Commonly, special programmes came in later upon the operation of the public schools.

Academic performance in most studies influences parents decision in selecting school for their children. However, in the case of these special education needs children, parents consider the children's ability for self care and management as a greater importance than just achieving top academic performance. Majority of the children with special education needs are among those with learning problems that explains, academic achievements as a bonus and not as the top priority. Especially for children with Down syndrome, hearing

impairment, the ability to communicate and to relate to their surroundings is of greater importance than the academic performance.

The second objective is to assess the issues faced by parents in selecting school for their special children. Based on the findings, the most common issue encountered by parents is the limited number of schools that provides suitable programme for children's special needs. The school distance have become a corresponding issue upon selecting a suitable public PPKI school. Distance to travel daily has a significant impact on the expenses and time. Distance becomes an issue for a parents with lower income group and those that cannot afford the time to travel out of their way to send of their child to school. Options are not available for all parents. The school distance and the location affects the mode of transportation, which explains the contribution of the school distance as part of the common issue in selecting school for children with special needs.

Other issue includes is the size of the education facility provided. The number of pupils enrolled into PPKI have been increasing over the years, however, the facilities provided have not been upgraded to meet the growing number of pupils. Schools find most PPKI classes to be overcrowded, where the number of pupils within a classroom exceeded the optimum number of maximum seven (7) pupils for each teacher. Due to the growing number of students and the limited number of schools providing a specified PPKI category, parents may have to be referred to several schools, before deciding which school is able to provide the resources required by the child for their learning progress. Due to the limited number of programmes offered, some parents were advised to enroll their children into other school which may not be their first choice. Parents' first choices would usually be schools with the best facilities that suits the child's special education needs as well as acceptable distance and desirable location. Being advised to consider other options may not be ideal for some of the parents.

## **RECOMMENDATION**

PPKI school siting should be as detailed and specific like public mainstream schools. The irregular distribution of PPKI schools within a district resulted in difficulties among parents in selecting schools for their special children. PPKI schools are often found to be overcrowded due to the limited number of schools offering PPKI within a district. The number of schools provided should be able to cater to the increasing number of pupils registered into the programme.

## **CONCLUSION**

This overview on the factors influencing parents is significant towards realizing better planning and facilities provision for special education especially in public schools. Adequate infrastructure and facilities becomes crucial as a basic support for the development of children with special needs. Quality educational facility

for special children should be one of MOE's top priority in education development aligned with its education principles that is to provide quality and equal education access for all children.

## REFERENCES

- Abrizah, A. & Ahmad, R. (2010). Systemic barriers: The challenges in the provision of inclusive school libraries in Malaysia. *Malaysian Journal of Library & Information Science*, 15(2), 19-40.
- Adepoju, T. L. & Oluchukwu, E. E. (2011). A study of secondary school students' academic performance at the Senior School Certificate Examinations and implications for educational planning and policy in Nigeria. *African Research Review*, 5(6), 314-333.
- Adeyemi, T. O. (2011). A comparative study of students' academic performance in public examinations in secondary schools in Ondo and Ekiti States, Nigeria. *Current Research Journal of Economic Theory*, 3(2), 36-42.
- Ali, M. M., Ramlee, M., & Jelas, Z. M. (2006). An empirical study on teachers' perceptions towards inclusive education in Malaysia. *International Journal of Special Education*, 21(3), 36-44.
- Bhattacharya, P. (2016). Comparison of educational facilities of mentally challenged children of special school and government school in Kolkata. *The International Journal of Indian Psychology*, 3(2), 132-149.
- Brock, M. E. & Schaefer, J. M. (2015). Location matters: Geographic location and educational placement of students with developmental disabilities. *Research and Practice for Persons with Severe Disabilities*, 40(2), 154-164.
- Bukhari, Z., Rodzi A. M., & Noordin, A. (2010). Spatial multi-criteria decision analysis for safe school site selection. *International Geoinformatics Research and Development Journal*, 1(2), 1-14.
- Burgess, S., Greaves, E., Vignoles, A., & Wilson, D. (2014). What parents want: School preferences and school choice. *The Economic Journal*, 125(587), 1262-1289.
- Coelli, M. B. (2011). Parental job loss and the education enrollment of youth. *Labour Economics*, 18(1), 25-35.
- Dunn, M. W., Cole, C. M., & Estrada, A. (2009). Referral criteria for special education: General education teachers' perspectives in Canada and the United States of America. *Rural Special Education Quarterly*, 28(1), 28-37.
- Easton, S. & Ferrari, E. (2015). Children's travel to school - the interaction of individual, neighbourhood and school factors. *Transport Policy*, 44, 9-18.
- Graham, B. C., Keys, C. B., McMahon, S. D., & Brubacher, M. R. (2014). Transportation challenges for urban students with disabilities: Parent perspectives. *Journal of Prevention & Intervention in the Community*, 42(1), 45-57.
- Huang, J., Guo, B., Kim, Y., & Sherraden, M. (2010). Parental income, assets, borrowing constraints and children's post-secondary education. *Children and Youth Services Review*, 32(4), 585-594.
- Ibrahim, N. M., Osman, M. M., & Bachok, S. (2014). Public school development and planning: Parents' criteria of selecting public school in Gombak District. *Procedia - Social and Behavioral Sciences*, 153, 274-285.

- Independent Schools council of Australia [ISCA] (2008). *Factors affecting school choice*. Retrieved from <http://isca.edu.au/blog/factors-influencing-school-choice/>.
- Jelas, Z. M. & Ali, M. M. (2014). Inclusive education in Malaysia: Policy and practice. *International Journal of Inclusive Education*, 18(10), 991-1003.
- Lee, C., Zhu, X., Yoon, J., & Varni, J. W. (2013). Beyond distance: Children's school travel mode choice. *Annals of Behavioral Medicine*, 45(Suppl 1), S55-S67.
- Leufer, T. (2007). Students' perception of the learning experience in a large class environment. *Nursing Education Perspectives*, 28(6), 322-326.
- Mat, M. N. A. (2001, November). Developing special education in each country and enhancing international mutual cooperation among countries in the Asia-Pacific region. *21st APEID Regional Seminar on Special Education*. November 8-23, 2001, Tokyo, Japan.
- Meynert, M. J. (2014). Inclusive education and perceptions of learning facilitators of children with special needs in a school in Sweden. *International Journal of Special Education*, 29(2), 35-52.
- Rahaman, F. (2014). *Inclusive educational environment for children with autism in Malaysian primary schools: Addressing the issues of wayfinding* (Master thesis). International Islamic University Malaysia, Kuala Lumpur, Malaysia.
- Schneider, M. (2003). *Linking school facility to teacher satisfaction and success*. Washington D. C.: National Clearinghouse for Educational Facilities.
- Yusuf, M. A. & Adigun, J. T. (2010). The influence of school sex, location and type on students' academic performance. *International Journal of Educational Sciences*, 2(2), 81-85.



## **A STUDY OF CONSTRUCTION WASTE PRACTICE IN SELANGOR**

**Khor Soo Cheen<sup>1</sup>, Lim Chin-Yieh<sup>2</sup>, Tan Seong Yeow<sup>3</sup>, Olanrewaju Adullateef Ashola<sup>4</sup>, Nik Nurul-Hidayah Nik Yahya<sup>5</sup>, Wai Soon Han<sup>6</sup>, & Mohaad Nizam Yusof<sup>7</sup>**

<sup>1,2,3,4,5,6</sup>*Faculty of Engineering and Green Technology,*  
UNIVERSITI TUNKU ABDUL RAHMAN MALAYSIA

<sup>7</sup>*School of Housing, Building and Planning*  
UNIVERSITI SAINS MALAYSIA

### **Abstract**

The development of construction sector has produced mass volume of construction waste. The aim of this research is to give background information on the construction waste problem in Selangor and to acknowledge the practical method of management in order to reduce construction waste. The quantification of construction waste is used to measure the waste index of the construction project in Selangor. A survey is conducted in order to collect the data needed in quantification of construction waste. The data is used to calculate the project waste indexes for construction projects. The amount of waste can therefore be detected explicitly to alert the construction stakeholders for undertaking preventive measures to reduce the waste production. The approaches adopted for construction waste reduction are stated in this research. The findings revealed that the studied companies practiced good management methods for construction waste. The results were prominent when compared with the benchmarked waste index of construction projects and demolition in Hong Kong.

**Keywords:** construction waste, quantification, waste index, waste reduction, Selangor.

## **INTRODUCTION**

The development of construction industry unfortunately generates plenty of by-products of construction waste. Construction waste is substance produced from demolition, excavation, renovation, refurbishment, road work and site clearance (HK EPD, 2015; Hashim, Rabe, Osman, & Zahari, 2017). However, the management of construction waste can be sorted for reuse, recycle and disposal for the purpose of environmental conservation. Besides that the type and amount of construction waste depend on the size of projects such as low rise project or high-rise project, construction technology deployment and the activities performed in the project (Masudi, Che Hassan, Mahnood, Mokhtar, & Sulaiman, 2011).

Extra estimation of material usually happens in pre-construction stage because of insufficient concern on waste generated in the planning stage and design stage. The extra estimation of the material use will cause the employer to pay more in material cost but decrease the contractor's profit margin ("Estimating Errors & Cost Overruns", 2016). The severe effect is the impact of construction waste illegal disposal to the environmental problem that might cause the adverse health problem to this society (Mohd Din, Nik Yahya, & Abdullah 2013).

One of the factors that cause inefficiency of managing the construction waste is lack well recycling markets. The waste management is inefficient and ineffective without a good recycling market (Tey, Goh, Kek, & Goh, 2016). This problem has to be solved by effective and systematic waste management planning to minimize environmental problems. To do so, the information such as waste generated amount, content of waste generated and types of method use to handle the construction waste have to be identified.

Additionally, the action of dumping the construction waste at landfill has cause major environmental problem. The amount of 7,375 tonnes of trash is being produced every day along with the disposal of construction waste. Selangor landfills have a short lifespan and the state is running out of suitable sites for new landfills (Goh, 2012).

The aim of this research is to provide background information on the construction waste problems in Selangor and propose a practical method on how to manage and reduce construction waste. In order to achieve the aim, the objectives are generated and listed in the following:

- i. To identify the quantification of construction waste being produced during construction.
- ii. To identify the types of construction waste.
- iii. To identify the approaches for the construction waste reduction.



## **LITERATURE REVIEW**

Construction and demolition project generate a lot of waste material. The waste substance include disposed rubbish and unnecessary material but also contain excavated materials such as rock and soil, construction material such as bricks, premixed concrete, timber and steel. Tons of concrete waste in Selangor can be found from the demolition of old structure, concrete waste retrieved after refurbishment of structural, building construction by-products and the scrapped waste from the road pavement. However, the use of crushed concrete debris as a substitute to fine aggregate to mortar mix is discovered (Ganuron Jr., 2015).

Timber is an excellent building material and its suitability is seen when the material is used for heavy construction, such as heavy duty columns, door and window frames, sills and wooden beams. Rebar is a common steel bar that is hot rolled and is commonly used as a tensioning device to reinforce concrete and other masonry structures to help hold the concrete in a compressed state (HarrisSupplySolution.com, n.d.).

Meanwhile, the waste of bricks might cause by the factors of such as: lack of supervision when unloading of bricks at site, poor handling issues and also induced during delivery process. The scrapped of pipes and wire are generated during the plumbing and mechanical process of work. The waste of pipes and wire are usually due to poor plumbing and electrical service design, poor planning of materials disposal at site and also due to design variation issues which caused the frequent changing of pipes and wires (Formoso, Soibelman, De Cesare, & Isatto, 2002).

However, Malaysia is yet to have the benchmarked waste generation rate in construction industry. By adopting the quantification of waste index formulated by Professor Chin Sun Poon for Hong Kong's construction project waste, the data of waste generated rate can be used for the comparison between Hong Kong and Malaysia. Hong Kong benchmarked waste generation rate comprises  $0.175\text{m}^3/\text{m}^2$  for public residential,  $0.250\text{m}^3/\text{m}^2$  for private residential and  $0.200\text{m}^3/\text{m}^2$  for commercial (Poon, Yu, & Ng, 2001).

Construction waste should not directly be disposed but it needs to pass through several processes before being disposed. The waste management hierarchy is a guide that is accepted for prioritising waste management practices with the goal of achieving friendly environmental effect. It sets out the preferred order of waste management practices (Zero Waste SA, 2012). The waste management hierarchy suggests that waste should be reduced, reused, recycled, recover then be disposed to proper dumpsite like landfill.

The good practice of waste classification avoid the direct disposal of hazardous substances into the landfill. The practise of onsite sorting out of waste should be initiated by every contractor in the construction sector. The contractor ought to train his employees to make the classification of material based on predefined waste hierarchy. The construction waste not only can be resell for

reusable but can help contractor save for the transportation cost of carrying the waste to the landfill.

At the end of the waste management hierarchy, the construction waste that is transported to the legal landfill without special haulers permit are required (Illinois EPA, 2015). The amount of disposal waste can be minimized through the enactment of construction waste disposal charging scheme which has been implemented in Hong Kong. The objective of the scheme is to issue the charges to waste producers based on the waste they produced. The enforcement imposes the contractor to reuse, recover and recycle wastes in order to reduce the bill of disposal waste (Lu & Tam, 2013).

The site waste management provides a principal which helps the contractors to estimate and record the amount and type of construction waste generated including the building up of the proper management actions for minimizing the quantity of construction waste. A license is issued to Duty Care stakeholders to record their waste carriers and monitor their waste management and illegal dumping (Papargyropoulou, Preece, Padfield, & Abdullah 2011).

## **RESEARCH METHODOLOGY**

Quantitative research involves collection of numerical data to understand a specific situation. The quantitative method that used in this research is the archival data in numerical based data collected through case study method from the target respondent. Data regarding the construction waste generated from a project is collected from the selected company. All the collected information from the survey were checked and verified for their correctness. The data is analyzed to obtain the major factors of the topic.

Quantification is used for collecting primary data of this survey. Quantification is carried out by collecting the data that is require to calculate the waste index from the construction company. The utilization of waste index is to investigate the total amount of waste generated per Gross Floor Area. The parameter used to calculate waste index is stated in the following:

- $V$  = truck volume (m<sup>3</sup>)
  - $N$  = total number of loads for waste proposal
- Total waste generated by the project,  $W = V \times N$ .  
Thus, Waste index =  $W / \text{GFA}$

## **RESULT AND DISCUSSION**

The Zero Waste Index was presented as an alternative assessment tool for measuring the produced waste in this management system. The Zero Waste Index quantifies for energy, material and water conservation through recycling efforts rather than just simply measuring the waste diverted from landfills (Zaman, 2014). The nearer waste index to the zero value indicate the effectiveness and efficiency of the company in managing the construction waste on site. The results

of the waste index retrieved from the quantification formulae are shown in Table 1. The data collected from the company includes gross floor area, truck volume, and total loads for waste quantification. The waste index in project A is  $0.1508\text{m}^3/\text{m}^2$ , project B is  $0.2940\text{m}^3/\text{m}^2$ , project C is  $0.0625\text{m}^3/\text{m}^2$  and project D is  $0.1534\text{m}^3/\text{m}^2$  in respectively.

**Table 1:** Project data collected in Selangor area

Project	A	B	C	D
Contractor	W	X	X	Y
CIDB Grade	G7	G7	G7	G7
Type of Building	Mixed Development: Commercial & Residential	Commercial: Building	Single storey Factory	Commercial Building
Duration	42 mth	15 mth	12 mth	36 mth
Gross Floor Area (GFA)	135,962m <sup>2</sup>	6250m <sup>2</sup>	21,989m <sup>2</sup>	62,288m <sup>2</sup>
Truck Volume (V) (m <sup>3</sup> )	16m <sup>3</sup>	16m <sup>3</sup>	16m <sup>3</sup>	16m <sup>3</sup>
Total loads for waste proposal (N)	1283 loads	121 loads	90 loads	552 loads
Calculation for Waste Index (C)	(16*1283)/135,962 = 0.1508	(16*121)/6,250 = 0.2940	(16*90)/21,989 = 0.0625	(16*552)/62,288 = 0.1534
Waste Index (C) (m <sup>3</sup> /m <sup>2</sup> )	0.1508	0.2940	0.0625	0.1534
Waste Management	Rebars and metals are reused and salvaged. System formwork being used to reduce timber waste. Majority of the waste manage by MPKj.	Rebars and metals are reused and salvaged. System formwork being used to reduce timber waste. Majority of the waste manage by MPKj.	Rebars and metals are reused and salvaged. Majority of the waste manage by MBPJ.	Rebars and metals are reused and salvaged. System formwork being used to reduce timber waste. Majority of the waste manage by MPKj.

In addition, the data of the waste index was supported by the secondary data of the sources of waste. The secondary data was used as an evidence to prove the accuracy of the data obtained. The name of company and project were not revealed due to the protection of the companies' privacy but the sources of waste

and the major material is stated in the table. The table of sources of waste is shown in Table 2.

**Table 2:** Sources of waste

Project	Sources of Waste	Major Material(s)
A	<ol style="list-style-type: none"> <li>1) Skim coat too thick.</li> <li>2) Overcast bored pile requires hacking of concrete and cutting the steel bar</li> <li>3) Hacking due to design change</li> <li>4) Lapping length of cantilever beam too long (design issue)</li> </ol>	Concrete, Rebar, Timber, Tiles, Plaster, Bricks.
B	<ol style="list-style-type: none"> <li>1) Change of trenches depth (design issue)</li> <li>2) Hacking of beam due to alignment issue</li> </ol>	Concrete, Rebar, Timber.
C	<ol style="list-style-type: none"> <li>1) Change of design (Steel Roof)</li> <li>2) Head of precast rc pile need to be cut off due to ground condition (pile setting length)</li> </ol>	Steel member, Concrete, Rebar.
D	<ol style="list-style-type: none"> <li>1) Overcast bored pile requires hacking of concrete and cutting the steel bar</li> <li>2) Lapping length of column starter bar too long</li> <li>3) Hacking of concrete slab due to water leakage issue (poor workmanship)</li> </ol>	Concrete, Rebar, Timber, Tiles, Plaster, Bricks.

The waste index of Project B was the highest among the projects which was  $0.2940\text{m}^3/\text{m}^2$  and went beyond the benchmarked standard norm of Hong Kong commercial project. The project involved activity of construction, demolition and refurbishment. In the job of refurbishment, the old design had to be demolished hence produced a large amount of construction waste. The waste produced after the demolition had to be placed temporarily at the waste storage and would be disposed by Kajang City Council in routine occasion. The stability of the building would be affected and caused plenty of changes in the building structural design.

Project C had the lowest waste index which was  $0.0625\text{m}^3/\text{m}^2$  and was far lower than the benchmarked rate of Hong Kong because the project was a single storey factory. Although the gross floor area of the project was not the smallest, but the number of storey height was the least compared to other four projects. The concrete and rebar became major waste produced in Project C after the cut off head of precast reinforced Concrete (R.C) pile due to the ground condition. In addition, the change of the roof design required the substitution of

the obsolescence steel roof that involved the removal and rework activities which inevitably caused the huge amount of generated scrapped steel.

The final two projects (Project A and Project D) had the appropriate same waste index value which were  $0.1508\text{m}^3/\text{m}^2$  and  $0.1534\text{m}^3/\text{m}^2$  in respectively. The comparison of benchmarked waste generation rate should take the middle result in between private residential and commercial because of project A was a mixed development and thus the reference value should be  $0.225\text{m}^3/\text{m}^2$ . However, the result was far lower than the benchmarked rate. The waste produced in Project A mainly caused by the human errors in the construction stage. Hence, the client required for changing in design hence led to the production of construction waste due to the hacking down of the structure for rebuilding. Lastly, the waste index of Project D was considered good and acceptable when compared with the benchmarked rate. The outstanding circumstance in Project D happened during quality inspection. Project D encountered the factor of the water leakage problem that might be caused by the poor workmanship. The negligence in supervising the construction of plumber in the installation of pipework plus the faulty skills of the plumber had magnified the water leakage problem. Hence, the hacking of concrete slab is needed in order to fix the problem of water leakage in piping system.

#### **CONCLUSION**

The findings of the study have answered all of the objectives in this research. The objectives of the research are achievable through the case study survey method. Notwithstanding, the archival data provided by the respondents are sufficient to support the objectives of the research. The quantification of waste index shows the effort level of each company to manage the construction waste being produced. The second objective is achieved through the literature review of this research and through the data provided by the respondents in the case study. The major types of the construction waste found in their projects are typically from the source of rebar, concrete, bricks and tiles.

The third objective represented in Table 1 stated the waste management approaches of the companies for the construction waste reduction. All the statement are retrieved from quoting the justification given by respective interviewee of the company. The projects stakeholders prefer to use the system formwork instead of using timber formwork in order to reduce the timber wastage to enable the repetitive use of system formwork. The waste of rebars and steel members are thus salvaged or resold to the recycle market. Last but not least, the fact that the company obtained waste index was nearly to zero is considered an optimum result after compared with the benchmarked waste index established in Hong Kong.

## REFERENCES

- Estimating Errors & Cost Overruns (2016). Retrieved from <http://buildingadvisor.com/estimating-errors/>
- Formoso, C. T., Soibelman, L., De Cesare, C., & Isatto, E. L. (2002). Material waste in building industry: Main causes and prevention. *Journal of Construction Engineering and Management*, 128(4), 317-325.
- Ganuron Jr., T. U. (2015). Recycling concrete debris from construction and demolition waste. *International Journal of Advanced Science and Technology*, 77, 7-24.
- Goh, P. L. (2012). Space running out for dumpsites. *Selangor Times, Issue 118* [Online] Retrieved from <http://www.selangortimes.com/index.php?section=insight&permalink=20120203120054-space-running-out-for-dumpsites>
- HarrisSupplySolution.com (n.d.) Retrieved from <http://www.harrissupplysolutions.com/steel-rebar.html>
- Hashim, K., Rabe, N. S., Osman, M. M., & Zahari, R. K. (2017). Solid waste management practice and environmental awareness level of postgraduate and undergraduate students: Case study of UTM. *Advance Science Letters*, 23(7), 6073-6077.
- Hong Kong Environmental Protection Department [HK EPD] (2015). *What is Construction Waste?* [Online]. Retrieved from <http://www.epd.gov.hk/epd/misc/cdm/introduction.htm>
- Illinois Environmental Protection Agency [EPA] (2015). *Construction and demolition debris*. Retrieved from <http://www.epa.illinois.gov/topics/small-business/publications/construction-debris/index>
- Lu, W. & Tam, V. (2013). Construction waste management policies and their effectiveness in Hong Kong: A longitudinal review. *The University of Hong Kong, Renewable & Sustainable Energy Reviews*, 23, 214-223.
- Masudi, A. F., Che Hassan, C. R., Mahnoon, N. Z., Mokhtar, S. N., & Sulaiman, N. M. (2011). Construction waste quantification and benchmarking: A study in Klang Valley, Malaysia. *Journal of Chemistry and Chemical Engineering*, 5(10), 909-916.
- Mohd Din, S. A., Nik Yahya, N. N. H., & Abdullah, A. (2013). Fine particulates matter (PM2.5) from coal-fired power plant in Manjung and its health impacts. *Procedia - Social and Behavioral Sciences*, 85, 92 – 99.
- Papargyropoulou, E., Preece, C., Padfield, R., & Abdullah, A. A. (2011, June). Construction waste management in Malaysia: A contractor's perspective. *Management and Innovation for a Sustainable Built Environment*. June 20-23, 2011, Amsterdam, The Netherlands.
- Poon, C. S., Yu, T. W., & Ng, L. H. (2001). *A guide for managing and minimizing building and demolition waste*. Hong Kong: Dept. of Civil & Structural Engineering, Hong Kong Polytechnic University.
- Tey, J. S., Goh, K. C., Kek, S. L., & Goh, H. H. (2016, December). Current practice of waste management system in Malaysia: Towards sustainable waste management. *1st FPTP Postgraduate Seminar: Towards Sustainable Management*. December 23, 2013, Batu Pahat, Malaysia.
- Zaman, A. U. (2014). Measuring waste management performance using the 'Zero Waste Index'. *Journal of Cleaner Production*, 66, 407-419.
- Zero Waste SA (2012). *Waste management hierarchy*. Retrieved from <http://www.zerowaste.sa.gov.au/about-us/waste-management-hierarchy>



**PLANNING MALAYSIA:**  
*Journal of the Malaysian Institute of Planners*  
**VOLUME 16 ISSUE 2** (2018), Page 225 - 235

## **FACTORS AFFECTING HOUSING PRICES IN MALAYSIA: ANALYSIS OF THE SUPPLY SIDE**

**AbdulLateef Olanrewaju<sup>1</sup>, Xin Ying Lim<sup>2</sup>, Seong Yeow Tan<sup>3</sup>, Jia En Lee<sup>4</sup>,  
& Hamimah Adnan<sup>5</sup>**

<sup>1,2,3,4</sup>*Faculty of Engineering and Green Technology*  
UNIVERSITI TUNKU ABDUL RAHMAN MALAYSIA

<sup>5</sup>*Faculty of Architecture, Planning and Surveying*  
UNIVERSITI TEKNOLOGI MARA, MALAYSIA

### **Abstract**

Buying a house is a major decision that homebuyers will make because expenditure on homeownership has an influence on the homeowner's quality of life. The housing price also influence developers' revenues and profit margins. Developers produce houses to make profits, however, with the increase in housing prices, homeownership rate and developers' profit performance will be affected. This study examines the reasons why housing prices are increasing in spite of the government's 'cooling' measures. Through a cross-sectional survey questionnaire, comprising 24 causes and 115 members of the housing developers and designers teams, 13 influential factors to the increase in housing prices were found. Additionally, the participants were also inquired on the five most influential factors causing the increase in housing prices. The factors include the shortage of materials, quality of materials, strategic factors, housing location and availability of transportation system. The results of the study are useful to developers, homebuyers and policymakers towards reducing housing prices.

**Keywords:** design deficiencies, new buildings, maintenance, obsolescence, housing

## **INTRODUCTION**

The demand for housing in Malaysia will increase as there is a positive correlation between housing performance and occupants' productivity, safety, well-being and satisfaction. As Olanrewaju and Woon (2017) explained, if housing location and cost fulfill users satisfaction, the government and public sector would spend less on the provision of healthcare facilities, recreations, crime preventions and pollutions, while productivity and prosperity increase. The ability to own a house is seen as an investment in most part of the world. People spend more than 50% of their productive time in their house. Expenditures on housing is high and for those who buy or build their houses, the property represent the single most expensive investment they make and for those that rent, the rental is often their single highest monthly or annual expenditure. Housing serves as both capital and consumption goods. Housing construction contributes significantly to the GDP in most countries. However, because the demand and supply of the housing market is uncertain, the decisions of homebuyers and the developers have strong impacts on the housing supply.

In most part of the world including the UK, the US, Japan, Hong Kong, Malaysia, Singapore, Australia, Ireland, and New Zealand, Nigeria, Indonesia and South Africa, housing is unaffordable (Demographia, 2017; Osman, Bachok, Shuid, & Khalid, 2017a). In most countries, households spent more than 30% of their disposable income to own or rent and operate a house or the price-to-income ratio is more than 3.0. Based on the Demographia, a ratio of more than 3.0 implies housing unaffordability. However, governments across the world have introduced measures and policies to increase the quality and quantity of housing supply in order to increase homeownership and increase the quality of life. In Malaysia, while homeowners' rate is decreasing at 1% annually, the unsold residential property and overhangs are increasing (Osman, Mohamad Yusop, Shud, & Abdullah, 2017b) To illustrate, the volume of transaction are 272,669, 246,225, 247,251 and 235,967 from year 2012 to year 2015 (NAPIC, 2015). The vacancy rate has increased from 6% in year 2010 to more than 10% in year 2015. MIER's Residential Property Survey Report conducted in 4Q 2015 found that 70% of the developers reported poor sales (REHDA, 2016) and many are homeless.

Academic literature leads to the conclusion that the major reason is that Malaysian housing prices are too high and has outpaced the increase in incomes and inflation (REHDA, 2016; KRI, 2015; "Loan criteria won't resolve", 2017). Various studies revealed that housings in Malaysia are 'severely unaffordable' or buyers are 'cost overburden' (Olanrewaju & Woon, 2017; KRI, 2015; "Loan criteria won't resolve", 2017; Demographia, 2017, Osman et al., 2017a; Osman et al., 2017b). Housing is severely unaffordable if the housing price to household income ratio exceeds 5.1 (Demographia, 2017). In a study conducted by Olanrewaju, Tat, Tan, Naoto and Abdul Aziz (2016), and Osman, Rabe, Abdullah, Rosl and Zainudin (2017c), they reported that most households in



Malaysia spent more than 30% of income to own or rent and operate their houses. In terms of index, the house prices have increased by 1.86 from 2009 to 2016 while that of the high rise is more severe with increase of 2.12 within the same period (NAPIC, 2017). Therefore, there is a need to provide an answer to why housing prices are increasing in Malaysia. There are multiple reasons responsible for the increase in the housing prices. A part of the problems could be accountable to developers, contractors, government policies, and third-party agencies. In this study, the causes of the increase are examined from the supply side perspectives. Empirical research that specifically address itself to causes of increase in housing prices from the experience of the providers (i.e. developers, design team, construction team and government) is lacking. It is important to investigate housing prices from the experience of the housing providers because housing is conceptualised, designed, constructed and sometimes operated by them. The housing providers know the operation of the housing market, and how they relate to government, third-party agencies and the homebuyers.

### **CONCEPTUAL JUSTIFICATIONS**

Housing is required to provide safety, security, protection, comfort, experience, satisfaction, and convenient to the home occupants. However, Malaysia is facing housing shortage problems, with a population of 31 million people (DOS, 2017) and 7.2 million housing stocks (DOS, 2014). There are fewer than 250 housing units per 1000 population. In order to increase the housing stocks and homeowners, the government have introduced many measures including schemes, programmes, and policies. These measures include MyHome, Perumahan Rakyat 1Malaysia (PR1MA), Rumah Mesra Rakyat (RMR1M), Program Rumah Mampu Milik (RMM), Program Penyelenggaraan 1Malaysia (TP1M), MyDeposit Scheme, Housing Loan Scheme, People's Housing Programme, Rumah Transit or transit house programme and MyBeautiful New Home. Similarly, subsidies and tax reliefs have been provided to homebuyers, developers and contractors. The government has relaxed its regulation on the EPF (Employee Prudential Fund) to enable contributors to use part of the savings as down payment for their housing loans. Developers offer discounts and split payments to home buyers. The developers (i.e. REHDA) also offer 'bridging' loan to home buyers because of the reduction in loan approval rate. The bureaucracies on land allocations are easing and the government has exempted construction property from the GST (Goods and Services Tax) and the restriction on the employment of foreign labour on contractors has been lifted. Meanwhile the housing turnover, neighbourhood instability, unsold and overhangs and dissatisfactions are high and increasing (Olanrewaju & Woon, 2017). The size of unsold property stood at 41% in 2015 and more than 22% of the housing property was overhang in 2015 (NAPIC, 2014-2015). Table 1 contains the price indices for the last eight years, where it can be seen that housing prices are increasing.

While income has increased by approximately 101% since 1999, housing prices have increased by more than 200% within the same period (Table 2). While the private final consumption stood at RM556.6 billion in 2015, housing operations constitute the largest part of the private consumptions (DOS, 2016). The implication of this is that for Malaysians to have a decent home, they will have to cut down expenditure on food, health, social life, entertainments, and education. While the consumer index for all major items dropped from 3.2 in 2011 to 2.1 in 2015, that of housing and its operations increase from 1.8 to 2.5 within the same period.

**Table 1:** The Malaysian Average House Price by House Type, 2009-2016

Year	All house	Terraced	High rise	Detached	Semi detached
2009	204,470	176,413	161,863	364,424	354,540
2010	215,678	185,505	172,651	382,512	374,697
2011	239,295	207,702	192,852	402,124	417,563
2012	271,384	234,934	223,735	454,186	465,612
2013	301,964	256,910	254,115	516,750	522,062
2014	330,428	284,136	277,729	565,869	554,402
2015	354,741	303,826	299,182	601,785	591,575
2016	379,843	326,445	326,204	642,775	619,767

Source: NAPIC (2017)

**Table 2** Annual House Price Index and house price 1999-2014

Year	Index (2000=100)	1-Yr % Change	Household income
2000	100	-	-
2001	101.1	6	-
2002	103.6	1.1	2,049
2003	107.7	2.5	-
2004	112.9	4	2,211
2005	115.6	4.8	-
2006	117.8	2.4	-
2007	124	1.9	2,552
2008	129.8	5.3	-
2009	131.8	4.7	2,841
2010	140.7	1.5	-
2011	154.6	6.7	-
2012	172.8	9.9	3,626
2013	192.9	11.8	-
2014	213.6	11.6	4,585
2015	236.2	7.3	-

Source: NAPIC (2017; 2014)

Thus, the policy question is what is the cause of the increase in the price of housing? The increase in housing is leaving many homeless and many are living in deplorable conditions. Although the increase in the housing prices can be examined from multiple stakeholders, this current study focused on the supply side including the contractors, developers, government agencies and the design teams. Increase in housing price would affect government policies, citizens' productivity and well-being. It would affect developers and contractors profit margins and revenues. Collectively academic literature suggests housing prices could increase because of many factors including, materials, location, interest rate, neighbourhood, social capital, lack of recreational facilities and transportation (Olanrewaju & Woon, 2017; Olanrewaju et al., 2016; Ying, Olanrewaju, & Tan, 2015; UN-HABITAT, 2011; Ong & Chang, 2013; Osman et al., 2017d). Although many studies have been conducted on housing prices, empirical studies on the causes based on developers and contractors experience are nascent or inconclusive.

#### **OUTLINE OF THE RESEARCH METHOD**

The survey was conducted in two phases which were through hand delivery and online survey. The first phase was administered to the respondents that attended the ARCHIDEX (International Architecture, Interior Design & Building Exhibition 2016) in the Kuala Lumpur Convention Centre using convenience sampling. ARCHIDEX is held annually and attended mostly by architects and other stakeholders in the construction sectors (i.e. engineers, quantity surveyors, developers, contractors) in Malaysia and around the South East Asian countries. The ARCHIDEX 2016 was held on 20 July 2016 to 23 July 2016 and attended by more than 3,000 delegates and exhibitors. This survey was conducted on 23<sup>rd</sup> (Saturday) July 2016. 96 completed survey forms were returned. The second phase was conducted through online Google survey form from November 2017 to December 2017. Respondents from the online survey were recommended to help forward the form to their colleagues that are competent to provide valid responses. By the cut-off date, which was four weeks after the online survey was first launched, 19 valid forms were returned. The factors leading to the increase in housing prices from literature (Olanrewaju & Woon, 2017; Olanrewaju et al., 2016; Ying et al., 2015; UN-HABITAT, 2011; Ong & Chang, 2013; Pillaiyan, 2015; Knight Frank, 2015) and the authors' experiences were included in the survey form.

#### **RESULTS AND DISCUSSION**

##### **Respondents' profile**

Altogether 115 valid survey forms were received and used for this study. 84% of the respondents have bachelor degree and postgraduate education. In terms of

their job positions, 36% of the respondents were architects, 9% was chief executive officers, and 12% were directors and managers. In terms of professional background, the majority (60%) were architects followed by engineers (12.2%) and quantity surveyors (5.2%). Most of the respondents worked for private organisations and about 60% had more than 5 year working experience (Table 3). Private firm implies (i.e. architectural, engineering, quantity surveying consulting firm) consultant companies. About 10% specifically worked for developers. 55% of the respondents were involved in affordable housing design and construction. Almost all the respondents had memberships in Board of Architect Malaysia, Board of Surveyor Malaysia or REHDA.

**Table 3** Cross-tabulation between working experience and organisation

Experience Organisation	Less than 5 years	5 - 10 years	10 - 15 years	15 - 20 years	More than 20 years
Government	3	1	0	0	0
Private Firm	38	14	5	6	17
Contractor	2	0	1	0	0
Developer	3	4	2	1	2
Supplier	0	2	5	2	0
Consultancy Firm	3	1	0	1	2
Total	49	22	13	10	21

### Analysing the Major Causes of Increase in Housing Price

In order to test the measures of goodness of the factors causing the increase in housing prices, Cronbach's alpha reliability and validity tests were performed. The reliability and validity tests indicated that the factors were suitable for the aim of this research (Table 4). To further confirm the strength of the data, Bartlett's test was conducted, the results showed a lack of multicollinearity among the factors and that the respondents were drawn from those with similar experiences ( $\chi^2(210) = 1423.511, p < 0.001$ ). The KMO is 0.720 and the R-matrix is 1.323E-006. The R-matrix indicated a lack of multicollinearity, hence adequacies of the data were justified. One sample t-test was computed to determine the hypothesis that each of the factors would lead to an increase in housing prices. For this reason, the null hypothesis was that the factor would not cause increased in housing price ( $H_0: U = U_0$ ) and the research hypothesis was that the factors would cause an increase in housing price ( $H_r: U > U_0$ ).  $U_0$  was the population mean. The comparison standard mean or critical level off point was set at 1.5. Table 5 contains the results of the t-test, where it was found that (i.e.  $Pr > |t|$ ) of each of the causes ( $H_r: U > U_0$ ) were significant. The small standard errors, being nearer to zero suggested that the measurements of the respondents with respect to the factors were representative. All the factors were statically

significant. Therefore, all the factors were adequate and suitable to be included in the survey to achieve the aim of the research.

The profile of the respondents is not discussed further, and only 13 main factors leading to the increase in housing price are briefly discussed after general discussions of the results are provided. Considering the relationship between the mean and standard deviation, the results interpreted that more than 70% of the respondents measured the factors that would increase prices of houses. In fact, the percentage of the respondents that disagreed or strongly disagreed was 27.52%. Exactly 42.35% agreed and strongly agreed to the ratings. 32.13% slightly agreed. It is also obvious that 13 of the factors were the most influential for estimating housing prices. Location was considered as the factor that had the highest influence on the housing price according to the entire respondents. 88% of the respondents indicated that the housing location had the highest impact on housing price. This result was expected because the price of lands and the associated costs related to land were varied extensively. Lands in the cities were very expensive compared to lands outside the cities. Regulations on lands and construction in the cities were also very strict, especially for affordable housing. It was also not surprising that the respondents rated the size of the house as the second most influential factor for housing price. This was because costs of construction were actually determined by the size of the house. For instance, in Malaysia, housing was priced at RM1, 200/m<sup>2</sup> in Kuala Lumpur. It was interesting to discover that innovation and skills were considered as the next most influencing factor on housing prices. This was not expected, however, construction costs were significantly influenced by the level of technology employed by the developers and construction on site. For instance, consultants' fees, claims and delay can also be reduced by using software like BIM.

**Table 4:** Distribution of ranking of factors leading to housing price

Cause	Strongly Agree	Agree	Slightly Agree	Disagree	Strongly Disagree	Reliability	Validity	Std. Deviation	Causal Index
Location - urban/rural	18	83	12	2	0	0.809	0.754	0.577	1.983
Size of the house	10	56	48	1	0	0.809	0.728	0.649	2.348
Innovation and skills	11	61	35	7	1	0.813	0.798	0.774	2.357
Developers' profit margin	12	63	28	10	2	0.814	0.793	0.852	2.365
Strategic factors	2	63	46	4	0	0.807	0.604	0.596	2.452
Shortage of material	7	66	24	16	2	0.813	0.730	0.872	2.478

Rising labour costs	14	40	24	37	0	0.791	0.871	1.046	2.730
Economic uncertainty and financial risks	13	40	27	35	0	0.794	0.884	1.020	2.730
Planning restriction on the use of land	6	24	79	5	1	0.802	0.758	0.660	2.748
Quality of material & component use	6	30	65	13	1	0.806	0.682	0.753	2.765
Leasehold / freehold house	0	54	33	28	0	0.796	0.829	0.817	2.774
Climate changes	0	55	32	25	3	0.825	0.774	0.874	2.791
Interest rates	9	35	41	30	0	0.800	0.589	0.920	2.800
Households confidence on future price	12	38	23	42	0	0.807	0.623	1.045	2.826
Number of new houses being built	3	28	62	22	0	0.804	0.734	0.730	2.896
Geographical factors	3	41	32	39	0	0.798	0.847	0.896	2.930
Availability of facilities [eg: swimming pool, gym room, basketball field, playground & etc.)]	13	25	29	44	4	0.804	0.844	1.096	3.009
Layout of the house	3	29	29	26	28	0.792	0.883	1.184	3.409
Stamp duty	5	18	38	25	29	0.793	0.877	1.157	3.478
Currency exchange rate	8	24	23	24	36	0.791	0.741	1.314	3.487
Permit fees	3	17	38	28	29	0.793	0.891	1.102	3.548

The developer's profits were also rated as a major factor that would cause the price of a house to increase and reduce. This was interesting and the finding was not surprising because previous research reported that the profit margin of Malaysian developers was very high at around 20% (Ying et al., 2015). Strategic factor, marked by the proximity of the housing to schools, hospitals, place of works, and the market was also rated to be a major determinant of housing prices. This was expected because housings that were close to schools, markets, and workplaces were preferable to homebuyers, for strategic reasons including a reduction in the cost of transports because of accessibility, conformability and conveniences reasons.

Material cost constituted about 60% of housing construction prices. Therefore, shortage and the associated increase in the cost of materials would have the significant impact on the housing price. Hence, it was not surprising that shortage or availability of materials was rated as an important factor in the estimation of housing price. It was interesting that the respondents also indicated that the labour cost would increase housing price.

The housing industry was labour intensive and most of the sites operatives were from the neighbouring countries. With government regulations on foreign labour, some projects were already been impacted. Economic uncertainty and financial risks were also measured as an influential contribution to housing price.

The profit margins of developers and contractors depend on the economic situations in a country especially due to imported goods and materials. Developers tend to reduce their investment in order to reduce their exposure to financial risks. Construction business involved large investments and as a result the developers also depend on loan from the banks. During recession, most businesses including housing developers would reduce their activities to reduce loss.

As previously stated, prices of lands had the most influential impact on the housing price. Therefore, restriction on the use of the land would undoubtedly upset the cost of construction and ultimately the price of the completed housing. Quality of materials was also found to make dominant bearing on the prices of houses. This was not surprising because the quality of materials determined housing production costs like any other goods and services in the marketplaces. The type of land ownership was also recognized as major factor influencing the prices of houses. This finding was not very surprising because leaseholders would not only have to worry about the grant rent on the land, but the land would be reverted back to freeholder on the expiration of the tenure. The result was consistent with literature.

The respondents also indicated that climate change would affect housing price. This finding was not difficult to agree with as heavy rainfalls, floods, mudslides are gradually becoming part of homebuyers' checklist in Malaysia. Homebuyers are demanding for houses that would be resistance to impact of earthquakes, landslides, and mudslides especially those at the hill-sides (Olanrewaju, Tan, Tat, & Mine, 2017). Without argument, interest rates had a significant impact on the cost of home production. Technically developers and contractors would transfer the amount they paid as interest to the homebuyers and this would, in turn, led to increase in the housing prices.

## **CONCLUSION AND RECOMMENDATIONS TO THE HOUSING PROVIDERS**

Meeting the housing need has been the primary agenda of the government. However, achieving this aim has been significantly difficult. More than 90% of the households cannot afford houses in the current situation without some assistance. Many ongoing houses projects are abandoned and the rate of overhang and unsold properties are high. This study provides an insight into the determinants of housing prices. This study has found the 13 main causal factors for the increase in housing price. The practical implications of the findings

reported is that the government need to lessen the regulations and control on lands in order to increase homeowners and also to reduce authorities' development charges. The developers also need to reduce their profit margin expectations through proper risk assessment and reduction. Future studies on similar topic should increase the sample size and examine the practical measures to reduce housing prices. Also, future research should investigate the relationships between the causes of increase in housing prices and the causal factors and examine the association among the factors. The ranking of the factors alone would not be able to provide structural advice to place managers, developers, urban planners and policymakers.

### **ACKNOWLEDGEMENT**

The research presented in this paper was supported in full by a grant from the "FRGS"; project: Analytical Investigation of Problems in Housing Supply in Malaysia. Project number: FRGS/1/2015/TK06/UTAR/02/2.

### **REFERENCES**

- Department of Statistics [DOS] (2014). *Report on characteristics of household 2010: Population and housing census of Malaysia*. Available at <https://www.statistics.gov.my>
- Department of Statistics [DOS] (2016). *Macro-economic key data at current prices*. Available at [www.statistics.gov.my](http://www.statistics.gov.my)
- Department of Statistics [DOS] (2017). *Current population estimates, Malaysia, 2016-2017*. Available at <https://www.dosm.gov.my>
- Demographia (2017). *13th annual Demographia international housing affordability survey: 2017 rating middle-income housing affordability*. Retrieved from [www.demographia.com/dhi.pdf](http://www.demographia.com/dhi.pdf).
- Khazanah Research Institute [KRI] (2015). *The State of Household*. Kuala Lumpur: Author.
- Knight Frank (2015). *Malaysian real estate highlights 2nd half 2015*. Retrieved from <https://www.knightfrank.com/publications/malaysia-real-estate-highlights-2h2017-5210.aspx>.
- Loan criteria won't resolve affordable housing issue. (2017, July 19). *The StarOnline*. Retrieved from <https://www.thestar.com.my/business/business-news/2017/07/19/bank-negara-loan-criteria-review-wont-resolve-affordable-housing-issue/>
- National Property Information Centre [NAPIC] (2014). *The Malaysian house price index by house type*. Available at [www.jp-ph.gov.my](http://www.jp-ph.gov.my).
- National Property Information Centre [NAPIC] (2014 - 2015). *Property overhang*. Available at <http://napic.jp-ph.gov.my/portal>
- National Property Information Centre [NAPIC] (2015). *Property market status report*:



- Q4 year 2015 (Property Overhang Q4 2015). Available at [www.jp-ph.gov.my](http://www.jp-ph.gov.my).
- National Property Information Centre [NAPIC] (2017). *The Malaysian house price index increased by 5.3% in QIP 2017 relative to Q1 2016*. Available at [www.jp-ph.gov.my](http://www.jp-ph.gov.my).
- Olanrewaju, A., Tat, L. L., Tan, S. Y., Naoto, M., & Abdul Aziz, A. (2016). Analysis of economic determinants of affordable housing price. In H. H. Lau, F. E. Tang, C. K. Ng, & A. Singh (Eds.), *Integrated solutions for infrastructure development* (pp. 1-6).
- Olanrewaju, A. & Woon, T. C. (2017). An exploration of determinants of affordable housing choice. *International Journal of Housing Markets and Analysis*, 10(5), 703-723.
- Olanrewaju, A., Tan, Y. S., Tat, L. L., & Mine, N. (2017). Analysis of homeowners' behaviours in housing maintenance. *Procedia Engineering*, 180, 1622-1632.
- Ong, S. T. & Chang, S. Y (2013). Macroeconomic determinants of Malaysian housing market. *Human and Social Science Research*, 1(2), 119-127.
- Osman, M. M., Bachok, S., Shuid, S., & Khalid, N. (2017a) Factors influencing housing prices among local people: a study in Perak, Malaysia. *Advanced Science Letters*, 23(1), 165-168.
- Osman, M. M., Muhamad Yusop, S. W., Shuid, S., & Abdullah, M. F. (2017b). Housing affordability index for districts in Perak. *Advanced Science Letters*, 23(7), 6049-6052.
- Osman, M. M., Rabe, N. S., Abdullah, M. F., Rosli, N. F., & Zainudin, F. E. (2017c) Housing affordability in the state of Melaka. *Planning Malaysia: Journal of the Malaysian Institute of Planners*, 15(1), 255-260.
- Osman, M. M., Ramlee, M. A., Samsudin, N., Rabe, N. S., Abdullah, M. F., & Khalid, N. (2017d). Housing affordability in state of Johor. *Planning Malaysia*, 15(1), 347-356.
- Pillaiyan, S. (2015). Macroeconomic drivers of house prices in Malaysia. *Canadian Social Science*, 11(9), 119-130.
- Real Estate and Housing Developers' Association Malaysia [REHDA] (2016). *MIER's residential property survey report 4Q 2015*. Available at <http://rehda.com/>
- UN-HABITAT (2011). *Affordable Land and Housing in Asia*. Nairobi: UNON, Publishing Services Section.
- Ying, X. L., Olanrewaju, A., & Tan, S.Y. (2015) Strategies for affordable housing delivery. *Australian Journal of Basic and Applied Sciences*, 9(25), 118-124.



**PLANNING MALAYSIA:**

*Journal of the Malaysian Institute of Planners*

**VOLUME 16 ISSUE 2** (2018), Page 236 - 245

## **MAQASID AL-SYARIAH & HUMAN WELL-BEING: A STUDY ON MELAKA'S PUBLIC HOUSING**

**Syafiee Shuid<sup>1</sup> & Muhammad Faid Mohd Zamin<sup>2</sup>**

<sup>1,2</sup>*Kulliyyah of Architecture and Environmental Design,  
INTERNATIONAL ISLAMIC UNIVERSITY MALAYSIA*

### **Abstract**

The need for proper housing for the people is an undeniable necessity that should be constantly monitored and researched. Housing opportunities should be made available for every individual, regardless of their income as it can be considered as one of the basic necessities for human life. In Islam, it preaches on a just, ethical, non-discriminatory (Qayyim, 1347 C.E.) and efficient protection of its follower's well-being, especially in providing social necessities such as housing. The relationship between the function of Maqasid al-Syariah and the public housing would be examined in this paper to determine the effectiveness of the Maqasid al-Syariah in the protection of human well-being. In order to analyze the relationship, a set of questionnaires pertaining on the satisfaction level of the society towards the housing market is distributed to 400 respondents equally divided among the three districts in Melaka. The study also concerns itself with the public housing community, as the focus of this research is aimed at the bottom 40% social group in Melaka. Under the Maqasid al-Syariah, the three domains which are the darurriyat (needs), hajiyyat (necessities), and tahsiniyyat (luxuries) are analysed based on the homeownership, housing condition, financial capacity and physical environment.

**Keywords:** public housing, maqasid al-syariah, well-being, Melaka, affordability

<sup>1</sup>Assistant Professor at International Islamic University Malaysia. Email: ssyafiee@iiu.edu.my

## **INTRODUCTION**

In recent years, Islam has taken the centre stage of every known media available, ranging from newspapers to social media, and has been portrayed as a backwards, outdated, war-loving religion that tramples over human-rights. A simple search on the internet could lead to a thousand articles repeating the same stigma of which had been imposed on the holy religion Islam. The gravity of this situation has become greater and greater as the hatred towards organized religions grow ever stronger. Though it is hard to fathom the concrete facts of what had become of Islam today, the search for peace and protection of well-being, be it inter or intra religion should be pursued relentlessly.

In order to digest what a religion is all about, one must take a look at what the religion is preaching to its followers, and the best example to analyze those is from its laws; the Syariah. Ibn al-Qayyim (1347 CE) mentions that Syariah is founded on the wholly on wisdom which aims to ensure the protection of the well-being of people in this life and the next. Any actions or rulings that do not correspond to the foundation of justice, mercy, wisdom and good are therefore discarded and disregarded from Syariah, even if they are claimed to be so according to some interpretation. Hence, Islam, in its most simplistic nature, advocates the caretaking of welfare of the whole population, not just its followers, as often misunderstood by the people.

In this research, a relationship was critically analysed between the implementation of Maqasid al-Syariah with the protection of human well-being, namely involving the supply of affordable houses in Melaka. It is assumed that the current situation would be illuminated through the completion of the research, where satisfaction and perception of the residents regarding the matter would be recorded and analysed.

## **OVERVIEW OF MAQASID AL-SYARIAH**

In essence, Maqasid al-Syariah can be loosely interpreted as wisdom behind a ruling, and acts as a principle that caters to the questions above (Auda, 2007). For example, the reasoning behind the ban on alcohol and intoxicants can be explained through the Maqasid that aims to preserve people's mind and souls. In addition, Ibn Ashur (1946) defines Maqasid al-Syariah as the general aspect which is the purpose and wisdom behind the enactment of all or most of the Syariah ruling. In literal terms, maqsid (plural: maqasid) can be defined as a purpose, objective, principle, intent, goal, or end (Auda, 2007). Hence, Maqasid al-Syariah is the abstract form of moral concepts of which the Syariah is based and becomes the direct link between the Syariah and today's notions of human rights, development, and civility.

Maqasid al-Syariah can be broken down into several key dimensions that are listed according to their hierarchy which are the necessities (*darurriyat*), needs (*hajiyat*), and luxuries (*tahsiniyyat*). The necessities are then further broken down

into several classifications which are preservation of religion, life, dignity or lineage, intellect and property (Afridi, 2016). It is agreed amongst many scholars that these necessities are the key reasoning behind every revealed law as they were considered essential for human well-being itself while the needs and luxuries are considered to be less essential and only acts as an enhancement of an individual's life. Hence the dimensions are interrelated with one another, with the 'needs' acting as a 'shield of protection' to the level of 'necessities' (Auda, 2007).

Auda (2007) further elaborates that he "find the levels of necessity reminiscent of the twentieth century's Abraham Maslow's hierarchy of human (rather than 'divine') objectives or 'basic goals,' which he called, the 'hierarchy of needs'" (p.32).

### **WELL- BEING**

Well-being or quality of life (QOL) is indeed a multi-faceted concept which is widely used globally although it is lacking a precise definition. According to Mohit (2013), the definition of QOL greatly varies between its authors who lived in different regions with their own perspectives which is mostly influenced by their own cultures, social environment and the level of economic development of each specific region. Mulligan, Carruthers and Cahill (2004) broadly interpret QOL as the "satisfaction that a person receives from surrounding human and physical conditions that are scale-dependent and can affect the behaviour of individual people, groups such as households and economic units such as firms" (as cited in Marans and Stimson, 2011).

Furthermore, Shucksmith, Cameron, Merridew and Pichler (2009) argue that "...well-being reflects not only living, but also the ways in which people respond and feel about their lives in those domains". The concept explains that the QOL is based on three main characteristics that are interrelated to each other. Firstly, the QOL focuses on individuals' life situations and their perceptions rather than a whole nation's. Secondly, it covers large dimensions and those dimensions vary greatly with each other but at the same time they co-exist with one another. Examples of such dimensions comprises of; housing conditions, education, employment and others. Finally, it brings together objective information on living conditions with subjective views and attitudes to provide a picture of overall well-being in society (Shucksmith et al., 2009).

Even though the authors differ in terms of their definitions on the concept of QOL, a middle-ground could still be found on the two contradicting definitions. Both Mulligan et al. (2004) and Schucksmith et al. (2009) agree that the quality of life affects all of the individuals regardless of their gender, race or any other differences between one another, and that their perceptions on the surrounding human and physical conditions, be it objective or subjective, are what matter in determining their overall QOL.

## **METHODOLOGY**

The research instrument used for the research is primarily based on questionnaire survey among 400 respondents that were distributed equally in the 3 districts in Melaka. The sample size was determined using a formula by Yamane (1967). For the sampling method, two methods were chosen, namely the stratified and convenience sampling. The list of public housing area in the study area was retrieved by using online sources acquired through the secondary data as well as from respective government departments.

These questionnaires were formulated based on the aspects of Maqasid al-Syariah, which falls under the three domains of Maqasid al-Syariah, which are the Necessities, Needs and Luxuries. In order to analyze the implementation of these domains towards the protection of human well-being, a set of questions were formulated, which includes:

- i. Homeownership
- ii. Challenges in owning a property
- iii. Housing condition
- iv. Financial capacity
- v. Physical environment

The homeownership and challenges in owning a property falls under the necessities domains, where an analysis was made in order to evaluate the homeownership rate and challenges in owning a property in Melaka. It is understood that the sample were mainly from the low-income group from the public housing community, hence this analysis is conducted to determine the effectiveness of the government in providing affordable housing to the population, as in line with the Maqasid al-Syariah. As for the needs domain, which is a complementary interest that would ease the hardship of the population, was measured by aspects of housing condition and financial capacity to determine the effectiveness of the implementation of Maqasid al-Syariah. Lastly, the luxuries domain was analysed through the physical environment which includes the quality of physical environment and social services.

## **FINDINGS AND ANALYSIS**

The questionnaires, as mentioned earlier were distributed to the public housing community in Melaka. These public housing were located in all three districts in Melaka. A total number of 10 public housing were chosen as the locations for questionnaire distribution. However, only two public housing were selected in Jasin due to the limited number of public housing in the district. A detailed information regarding the study area is as shown in Table 1.

**Table 1:** List of public housing selected as samples in Melaka

District	Name	Number of Samples	Public Housing Type
Melaka	PPR Sungai Putat	34	PPR
	Rumah Awam Pulau Gadong	34	
	Rumah Awam Bertam Malim	33	
	Rumah Awam Bukit Rambai 2	33	
Alor Gajah	Rumah Awam Rembia	34	PAKR
	Rumah Awam Seri Pengkalan	33	
	Rumah Awam Paya Datok	33	
	Kampung Tebing Tinggi	34	
Jasin	Taman Seri Chin Chin	66	
	Taman Kelubi Damai	66	
<b>Total</b>	<b>10</b>	<b>400</b>	

Source: Lembaga Perumahan Melaka

**Table 2:** Respondents' economic capacity and residential profile

Categories	Frequency	Percentage (%)
<b>Average Monthly Household Income</b>		
RM1,000 and below	26	6.8
RM1,001 – RM2,000	59	15.5
RM2,001 – RM3,000	123	32.4
RM3,001 – RM4,000	87	22.9
RM4,001 – RM5,000	52	13.7
RM5,001 – RM6,000	25	6.6
RM6,001 – RM7,000	4	1.1
RM7,001 – RM8,000	1	0.3
RM8,001 – RM9,000	3	0.8
<b>Total</b>	<b>400</b>	<b>100.0</b>
<b>Mean</b>	<b>RM2,790.00</b>	
<b>Type of House</b>		
Terrace	383	95.8
Flat	17	4.3
<b>Total</b>	<b>400</b>	<b>100.0</b>
<b>House Price at Purchase</b>		
RM50,000 and below	298	75.4
RM50,001 – RM100,000	52	13.2
RM100,001 – RM150,000	24	6.1
RM150,001 – RM200,000	21	5.3
<b>Total</b>	<b>395</b>	<b>100.0</b>
<b>Mean</b>	<b>RM49,773.90</b>	
<b>Home Ownership</b>		
Own	355	88.8
Rent	45	11.3

<b>Total</b>	<b>400</b>	<b>100.0</b>
--------------	------------	--------------

For the average monthly household income, the findings showed that the mean amounted to RM2,790.00 per month, which was significantly lesser than the national average of RM3,626 per month in 2012 (Institut Rakyat, 2014). To a certain degree, it showed that the respondents were made up from the bottom 40 percent household income group. In terms of housing type, it was identified that the types were divided into two categories, which were terrace houses and flats. The majority of the respondents were living in landed public housing with the percentage of 95.8% while the remaining resided in flats.

In addition, the mean housing price at purchase identified is RM49,773.90, which was extremely affordable although most of the houses purchased decades ago. To compare, the median market price for houses of all housing types in Melaka in the year 2014 was RM181,044 (Khazanah Research Institute, 2015).

It was also observed that 11.3% of the respondents rented the houses they were residing while the majority of the respondents own their properties (88.8%). In light of this, it was identified that though the housing market was considered affordable in Melaka, a portion of the population preferred or had to rent a house to reside in.

**Table 3: Challenges in owning a property**

No.	Challenges	Frequency	Percentage (%)
1	Eligibility/approval	14	3.5
2	Inadequate income	183	45.8
3	Personal loan	66	16.5
4	Difficulties in Paying the Deposit	65	16.3
5	High processing fees	19	4.8
6	No issues	53	13.3
	<b>Total</b>	<b>400</b>	<b>100.0</b>
	<b>Mean</b>	<b>3.13</b>	

The table above illustrates that almost half of the respondents (45.8%) felt that inadequate monthly income was the greatest obstacle in obtaining a property in Melaka. Even though with Melaka's affordable housing market, the low-income group of the population faced difficulties especially in regards to income when trying to own a property. Other concerning challenges include the personal loan (16.5%) and having difficulties in paying the deposit (16.3%). Both of these issues relate to the inadequacy of income suffered by some of the respondents. As mentioned earlier, the average monthly household income of the respondents amounted to only RM2,790.00 which proved difficult even to own a house in an affordable market.

With the current housing affordability in Melaka, and the number of public houses supplied, it could be assumed that the government's efficiency in providing public housing were quite commendable and reliable. Furthermore, based on the Melaka Housing Institute, numerous affordable housing projects are currently underway to ease the demand of affordable housing in Melaka.

However, as Table 3 suggests, the main concern was more focused towards the inadequate income that were shrouding the majority of the respondents. As the objective of the Maqasid al-Syariah is practically to ensure that the human well-being is rightfully protected, several measures should be proposed and monitored to tackle the issue of income inadequacy.

Nevertheless, the provision of affordable housing was quite well taken-care off in Melaka, which is in line with the purpose of Maqasid al-Syariah, particularly under the domain of necessities (darurriyat).

With regards to the results shown in Table 4, it was identified that the majority of the respondents (93.8%) were satisfied with their current housing condition that includes the aspects of comfortability of home and its quality in meeting their daily needs. In addition, the quality of home in meeting daily needs had a higher relationship towards the satisfaction level in comparison with comfort based on the Pearson's r score, though both scores are considered to be weak relationships.

For financial capacity, the respondent's perception on their overall satisfaction were between average and satisfied with a mean score of 3.43. It was identified that the respondents were more affected with the financial difficulties that they were facing instead of adequacy of income.

**Table 4:** Housing condition, financial capacity, and physical environment

Aspect	Percentage (%)					Mean	Pearson's R
	1	2	3	4	5		
<b>Housing Condition</b>							
Home comfortability	0.0	6.3	3.8	46.5	43.5	4.27	0.27
Quality of home in meeting daily needs	1.5	0.5	5.3	62.8	30.0	4.19	0.13
<b>Overall satisfaction with housing condition</b>	<b>0.0</b>	<b>0.3</b>	<b>6.0</b>	<b>48.3</b>	<b>45.5</b>	<b>4.09</b>	<b>1.00</b>
<b>Financial Capacity</b>							
Income adequacy	0.5	3.0	12.8	66.3	17.6	4.09	0.12
Financial difficulties	37.0	43.5	14.3	4.8	0.5	1.88	-0.29
<b>Overall satisfaction with financial capacity</b>	<b>9.5</b>	<b>11.3</b>	<b>21.8</b>	<b>41.5</b>	<b>16.0</b>	<b>3.43</b>	<b>1.00</b>
<b>Physical Environment</b>							
Quality of physical environment	3.8	2.5	8.0	55.0	30.8	4.07	0.28



Wariness on noise pollution	29.5	43.5	6.0	15.5	5.5	2.24	-0.64
Quality of surrounding social services	0.0	2.8	5.3	56.3	35.8	4.25	0.27
Safety and security of the environment	1.5	1.0	2.5	24.5	70.5	4.62	0.53
<b>Overall satisfaction with physical environment</b>	<b>0.0</b>	<b>0.5</b>	<b>13.8</b>	<b>46.8</b>	<b>39.0</b>	<b>4.24</b>	<b>1.00</b>

In terms of physical environment, most of the respondents felt that the quality of their physical environment were very good and were satisfied. Furthermore, 95% of the respondents felt safe and secure in regards to the home environment while 92.1% are happy with the quality of social services available in the area.

Hence, in terms of the domains of needs and luxuries, it was identified that majority of the respondents, as per Table 4, were satisfied with their housing condition and physical environment, although the financial aspects being a lesser out of the three. There were no hardcore issues identified based on the respondents, and majority of the respondents were satisfied with the current condition of their lives.

## CONCLUSION

Based on the findings, it is identified that overall, the respondents enjoyed an affordable housing market, as majority of them (88.8%) own their property with an average household monthly income of RM2,790.00. This suggests that the provision of housing which is considered as a basic necessity of every individual is properly taken care of both by the government, even though there are still a group of minorities who are still not able to own a house. These situations occur most probably due to the income inadequacy as stated by the challenges that was felt by the respondents during the home owning process.

Be that as it may, majority of the respondents are satisfied with their housing condition, financial capacity as well as their current physical environment that encompasses safety and social services. There are no severe issues identified by the respondents, and majority of them are currently happy with their current state of affairs.

All in all, in line with the dimensions of Maqasid al-Syariah, the public housing in Melaka suits the needs of the respondents and are in good quality that satisfies the requirements for the residents to live their daily lives. Furthermore, the government's efficiency in providing public housing are quite commendable and reliable. Based on information from the Melaka Housing Institute, numerous affordable housing projects are currently underway to ease the demand of affordable housing in Melaka.

However, there are still improvements to be made to ensure that the dimensions of Maqasid al-Syariah are thoroughly implemented to achieve the goal to protect humans well-being. A better employment opportunity as well as financial assistances to the hard core-poor from the welfare organization should be sufficient in order to elevate the respondent's quality of life.

## REFERENCES

- Afridi, M. A. K. (2016). Maqasid al-shari'ah and preservation of basic rights: Under the theme "Islam and its perspectives on global & local contemporary challenges". *Journal of Education and Social Sciences*, 4, 274-285.
- Auda, J. (2007). *Maqasid al-shariah as philosophy of Islamic law (A systems approach)*. London: The International Institute of Islamic Thought.
- Ibn al-Qayyim (1347 C.E.).
- Ibn Ashur, M. a.-T. (1946). *Treatise on maqasid al-shariah*. London: International Institute of Islamic Thought.
- Institut Rakyat. (2014). *Key statistics*. Institut Rakyat.
- Khazanah Research Institute. (2015). *Making Housing Affordable*. Kuala Lumpur: Author.
- Marans, R. W. & Stimson, R. J. (2011). *Investigating quality of urban life: Theory, methods and empirical research*. Dordrecht: Springer.
- Mohit, M. A. (2013). Quality of life in natural and built environment - An introductory analysis. *Procedia - Social and Behavioral Sciences*, 101, 33-43.
- Mulligan, G., Carruthers, J., & Cahill, M. (2004). Urban quality of life and public policy: A survey. *Contributions to Economic Analysis*, 266, 729-802.
- Shucksmith, M., Cameron, S., Merridew, T., & Pichler, S. (2009). Urban-rural differences in quality of life across the European Union. *Regional Studies*, 43(10), 1275-1289.
- Yamane, T. (1967). *Statistics - An introductory analysis* (2nd Edition). New York: Harper and Row.



**IDENTIFYING THE LEVEL OF COMMUNITY INVOLVEMENT IN  
THE COMMUNITY ACTIVITIES AT KG. KUALA TELANG, KUALA  
LIPIS, PAHANG**

**Maheran Yaman<sup>1</sup>, Zainul Mukrim Baharuddin<sup>2</sup> & Haza Hanurhaza Md  
Jani<sup>3</sup>**

<sup>1,2,3</sup> *Kulliyah of Architecture and Environmental Design,*  
INTERNATIONAL ISLAMIC UNIVERSITY MALAYSIA

**Abstract**

A community is a particular group of people that are bound by a similar cultural practice and activities. The continuation of the practising the local culture developed an identity for the community. Through time, the identity is strengthened by the level of community involvement in response to their participation in preserving the culture. The lack of community involvement would result to decreasing number of cultural practices. Eventually, the process contributed to a negative impact on the local identity. This paper addresses the importance of a community involvement concerning safeguarding the local culture and practices. Two objectives are outlined in achieving the aim. Firstly, to identify the list of the community activities. Secondly, to determine the level of community involvement at Kg. Kuala Telang, Kuala Lipis. A quantitative method of analysis is adopted in the paper to achieve the objectives. The survey questionnaire is distributed to 58 respondents, and the result is analysed using descriptive statistics and Spearman correlation tests. The findings from the data collection are arranged into four categories, and the result is discussed accordingly as to answer the aim and objectives of the paper. As a final remark, the paper highlights the importance of community involvement and the methods to ensure the level of participation in response to community activities in the village.

**Keyword:** community involvement, village, culture, identity

<sup>1</sup> Assistant Professor at International Islamic University Malaysia. Email: maheran@iium.edu.my

## **INTRODUCTION**

Community involvement is defined by UNESCO as a process of developing a participation and cooperation of an individual in a particular community as a method to accomplish a specific activity (UNESCO. 2003). A community is bound by a specific cultural practice; the practice gradually shaped the identity of the local people (Bakar, Osman, & Bachok, 2012a; Smith & Akagawa, 2009). For that reason, community involvement holds an important role in strengthening the social structure and protecting the cultural identity of a community (Abdullah, 2011; Lewicka, 2008; Smith, 2006). In short, the level of community involvement contributed in building up the social activities of a community. The lack of community involvement would result in the degrading on the cultural and local identity of a particular community.

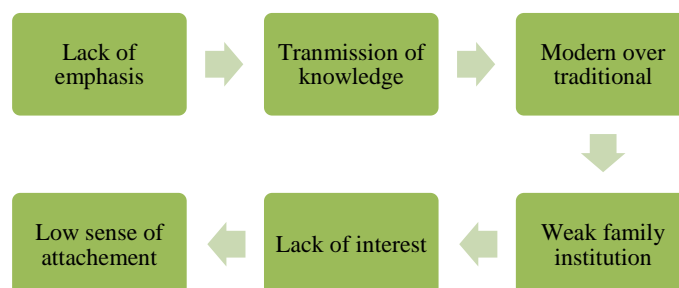
In regards to the statement, this paper is accentuated on identifying the level of community involvement at Kg. Kuala Telang, Kuala Lipis, Pahang. In general, the issues discovered in a village revolved around the method to protect and preserve a local culture as well as traditional practices. The lack of practising the traditional culture would cause the disappearing of a local identity for a particular community. For that reason, this paper aims to emphasise the importance of a community involvement in regards to safeguarding the local culture and practices. Two objectives are highlighted that are to identify the list of the community activities as well as to determine the level of community involvement in the village. The effort is perceived as an attempt to discover a technique in ensuring a perseverance of a community participation.

## **LITERATURE REVIEW**

Community involvement is strongly related to the place attachment and sense of belonging to a specific area (Schmid, 2003; Bakar et al., 2012a; Moliner, Sales, & Sanahuja, 2017; Omar, Omar, Othman, & Yusoff, 2016). The level of attachment contributed to developing a willingness to participate with the community activities (Corcoran, 2002). For that reason, the understanding of the community origin, as well as history, helps in increasing the sense of attachment and belonging to the place (Firmansyah & Fadlilah, 2016).

However, several studies have identified the contributing factors that led to the low level of community involvement. Among them are the lack of emphasis on the importance of individual participations (Bakar et al., 2012a; Bakar, Osman, & Bachok, 2012b; Garnett, Cooper, Longhurst, Jude, & Tyrrel, 2017), the deficiency in transmitting the knowledge on the local culture and tradition (Carli, 2001; Schmid, 2003), interference of contemporary over traditional practices (Abu Sadat, 2008; Bakar et al., 2012b; Beel et al., 2017; Omar et al., 2016), weak family institution, the need of practicing the tradition as well as the lack of interest and sense of attachment to the place (Whelan, Tellez, O'Brien, & Fragoso, 2008; Frank, & Lewis, 2004; Richwine, 2012; Tuan, 1977; Manzo & Perkins, 2006;

Omar et al., 2016). They are observed as the factors that are causing the lack of community involvement. The causes are illustrated in Figure 1.



**Figure 1:** Causes to the lack of community involvement

There are several reasons to have caused the lack of community involvement. Therefore, the need to underline the importance of strengthening the community involvement are foreseen as necessary. Transmission of knowledge regarding the community activities is viewed as one of the steps to ensure the survival and continuity of community participation (Smeets, 2003; Smith & Akagawa, 2009). The knowledge on the importance of maintaining the community involvement would develop the sense of appreciation, and it would eventually encourage the community to participate in the community activities actively.

## **METHODOLOGY**

This paper is developed from a quantitative research. The survey questionnaire is intended to identify the level of community involvement at Kg. Kuala Telang, Kuala Lipis, Pahang. The questionnaire is structured into three main sections consisted of 18 questions. The first section is focusing on the respondent profile while the second sections are targeting to identify the types of community activities that are currently taking place in the village as well as the respondents level of interest on each of the activities. A total of 24 activities are outlined with ten different lists on the level of interest. The result determines the list of community activities at the village and the level of its importance according to the local people. The final section consisted of 3 questions, and each of the questions is measured by a 5 point Likert scale ranging from strongly disagree to strongly agree.

A random sampling technique is adopted, and a total of 58 respondents are approached to answer the questionnaire. The data gathered is analysed using SPSS Statistics Software version 20. In order to determine the level of

consistency in the structure of the questionnaire, a Cronbach's alpha is run. The value of the Cronbach's alpha for each section obtained 0.82 which indicate a good level of internal consistency.

## DATA ANALYSIS AND FINDINGS

The result from the data collection is presented in four categories namely the demographic data, the level of community involvement, the premeasured step to increase community involvement, and suggestion to improve the community involvement in the village. The detail on the findings is elaborated in the following subsection.

### Demographic Data

Based on the total 58 respondents, the analysis revealed 38 respondents are male while the remaining 20 are female. The age classification shows the population in the village ranges from young adult (ages 10-30years, pct.=22.4%), middle-aged adults (ages 31-50years, pct.=41.4%), and older adults (age 51 and above, pct.=36.2%). The number of respondents originated from the village are classed into two categories, namely the local people (86.2%) and non-local people (13.8%). The percentage of the local people shows a potential for a high level of the sense of attachment towards the village. The years of residence is viewed as a method to evaluate respondent's level of attachment. The result is presented in Table 1.

**Table 1:** Years of residence

<b>Level of Attachment</b>	<b>Years of Residence</b>	<b>F.</b>	<b>%</b>
Low attachment	: < 15 years	7	12.1
Middle attachment	: 16 – 30 years	21	36.2
High attachment	: 31- 45 years	13	22.4
Very High attachment	: > 46 years	16	27.6

Based on the result in Table 1, it is discovered that 50% of the total respondent demonstrated a high and very high level of attachment. Meanwhile, 36.2% had a middle level of attachment to the village. The result was interpreted as "the longer the respondent resides at the village, the higher their level of attachment." Therefore, the demographic data shows the middle to older adults has higher sentiment as well as personal attachment to the village.

### The Level of Community Involvement (CI) in the Village

According to the result of the importance of the community activities, 98.3% of the respondent agreed that the activities are perceived as an important aspect that connecting the local people. Moreover, the activities are viewed as a benefit towards the local people as 100% of the respondent demonstrate a positive response towards the subject. Besides, the respondent highlighted there main

important people that played a significant role in influencing the involvement of the community. The highest contributor is the village development and security committee (74.1%), followed by family members (13.8%) and the third biggest contributor in influence the community involvement was neighbours (12.1%). It is discovered that the village development and security committee hold the most significant influence in increasing community involvement in the village. The result is presented in Table 2.

**Table 2:** Role in influencing the CI

<b>Influence by</b>	<b>F.</b>	<b>%</b>
Family Members	8	13.8
Neighbours	7	12.1
Village Development and Security Committee	43	74.1
District Council	0	0.0
State Government	0	0.0

In regards to the community involvement, there was a total of 24 activities conducted in the village. Based on the activities, the respondents were surveyed with their level of interest in participating in the activities. The result showed a great difference in the weightage of the community interest towards the activities (Figure 2).



**Figure 2:** The weightage on the level of community interest

The majority of the respondents were interested in participating, and the activities were viewed as a need by the local people. Nevertheless, the local people had no experience in involving with the detail of the activities such as i) community nature sanctuary (44.83), ii) livestock products (41.38%), iii)

traditional performing arts as well as nature-based outdoor adventure (39.66%) and iv) nature night tour as well as handicraft products (36.21%). Among the 24 activities, the six activities mentioned above have obtained the four highest percentage in regards to the community need but lacking in term of experience. Therefore, the findings highlighted the list of the potential activities needed by the community that can be further developed or emphasised on.

Among the weightage of community interest, the result also showed the respondents were uninterested in participating in with activities. The lack of interest is interpreted as a threat towards community involvement in participating in the local activities. The study demonstrated the causes towards the lack of community involvement and interest. A correlation was conducted to identify the causes, and the result is presented in Table 3.

**Table 3:** Correlation on the causes

<b>Causes</b>	<b>1</b>	<b>2</b>	<b>3</b>	<b>4</b>	<b>5</b>	<b>6</b>	<b>7</b>	<b>8</b>
1. Emphasis	1							
2. Interest	0.65	1						
3. Guidance	0.63	0.67	1					
4. Support	0.75	0.59	0.61	1				
5. Modern Life	0.40	0.46	0.49	0.55	1			
6. Appreciation	0.67	0.68	0.67	0.74	0.68	1		
7. Socioeconomic	0.55	0.60	0.47	0.61	0.43	0.71	1	
8. Other culture	0.51	0.48	0.51	0.55	0.50	0.68	0.59	1

\*\*Correlation is significant at the 0.01 level (2-tailed)

In general, there were eight causes of the lack of community involvement in participating in the community activities. Among them was the lack of emphasis, interest, guidance, support, appreciation, interference of modern lifestyle and other culture as well as imbalance socioeconomic. Based on Table 3, with 99% confidence level, 11 variables with a strong correlation were discovered, and the result was presented as follows (p-value <0.01):

- i. The lack of emphasis was strongly correlated with lack of interest ( $r= 0.65$ ), support ( $r=0.63$ ), guidance ( $r= 0.75$ ) and appreciation ( $r= 0.67$ ).
- ii. The lack of interest was strongly correlated with the lack of guidance ( $r= 0.67$ ) and lack of appreciation ( $r= 0.68$ ).
- iii. The lack of guidance was strongly correlated with the lack of appreciation ( $r=0.67$ ).
- iv. The lack of support was strongly correlated with lack of appreciation ( $r=0.74$ ).
- v. The interference of modern lifestyle was strongly correlated lack of appreciation ( $r=0.68$ ).
- vi. The lack of appreciation was strongly correlated with the imbalance socioeconomic ( $r=0.71$ ) and interference by other culture ( $r=0.68$ ).



The result highlights the list of the variable on the causes of the lack of community involvement, which had a strong correlation with other variables. As the causes were viewed as the reasons for lack of community involvement; therefore, there is a need to address a method to overcome the issues. Based on another correlation test on the needs of the community, a premeasured step in overcoming the lack of involvement is identified. The detail explanation is discussed in the following subsection.

### **The Premeasured Step to Increase the Community Involvement in the Village**

Causes of the lack of community involvement have been identified, and therefore, a premeasured step to increase the level of participation is accentuated in the study. In general, the premeasured steps are targeted to underline the community needs as anticipated by the respondent. There are five strong correlations with 99% confidence level identified in response to the method to increase local involvement in the village. The relationships are presented as follows (p-value <0.01):

- i. Personal involvement was strongly correlated with the strength of the community activities ( $r= 0.60$ ).
- ii. The ability to transmit information between the community (local people) was strongly correlated with the confidence to transmit information to other people or tourist ( $r= 0.79$ ), and the practice would increase the number of tourists ( $r= 0.62$ ).
- iii. The effort to promote on cultural activities to the tourist was strongly correlated with the increasing number of tourist ( $r= 0.66$ ).
- iv. The need to generate and increase income was strongly correlated with the aspiration to participate in the community activity ( $r= 0.62$ ).
- v. The confidence to voice out opinion was strongly correlated with the ability to generate personal income ( $r= 0.64$ ).

Based on the five relationships, it is revealed that the means to increase the local involvement include personal participation to strengthen the foundation of the community activities. Moreover, personal ability to deliver information about the community to other local people would develop confidence in transmitting the information to other people and eventually, this would increase the number of tourists. Furthermore, the effort to promote the activities would also contribute in inviting more tourists at the village. Other than that, personal participation in the community activities, as well as the confidence to express an individual opinion, showed a positive effect towards increasing or generating income. An individual participation opens an opportunity for them to voice out their opinion towards the possibility to enhance profits and financial stability in the village.

The following subsection explains on the list of suggestion by the respondent on a method to improve the community involvement.

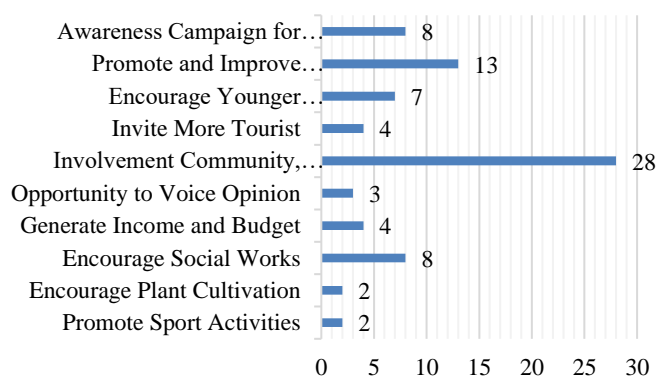
### **Suggestions to Improve the Community Involvement in the Village**

This paper emphasises on the community involvement in Kg. Kuala Telang. It also highlights the causes of the lack of involvement as well as the premeasured steps to increase local participation. The respondent addresses suggestions to improve the current condition in the village. The suggestions are observed as a contribution to ensure the community activities in the village can be prolonged and practiced in the future.

In detail, the list of suggestions mentioned by the respondent is categorised into ten aspects. The aspects are underlined in response to the method anticipated to enhance the community involvement. The ten aspects are:

1. Awareness Campaign for Community Activities
2. Promote and Improve Community Activities
3. Encourage Younger Generation to Participate
4. Invite More Tourist
5. Active involvement by the Community, JKKK, ADUN, Government, and NGO
6. Opportunity to Voice Opinion
7. Generate Income and Budget
8. Encourage Social Works
9. Encourage Plant Cultivation
10. Promote Sport Activities

These are among the important suggestion highlighted by the respondent in regards to the community involvement in the village. The findings on the importance of the aspect are gathered through frequency count, and the result is presented in Figure 3.



**Figure 3:** The list of suggestions addressed by respondents

According to Figure 3, the three main suggestions as mentioned by respondents are: i) to have an active involvement within the community, JKKK, ADUN, Government and NGO's (freq: 28, pct: 48.28%), ii) to promote and improve community activities (freq: 13, pct: 22.41%) and iii) to encourage social works (freq: 8, pct: 13.80%); and awareness campaign for community activities (freq: 8, pct: 13.80%).

The list of suggestions can be prioritised into ranking. The rank indicates the ranges for the importance of the aspect suggested by respondents. In short, the frequency count had identified seven ranking to prioritise the list of suggestion. The detail on the result is presented in Table 4.

**Table 4:** Ranking on suggestions

Ranking	Suggestions
One	Involvement Community, JKKK, ADUN, Government and NGO
Two	Promote and Improve Community Activities
Three	Encourage Social Works; and Awareness Campaign for Community Activities
Four	Encourage Younger Generation to Participate
Five	Generate Income and Budget; and Invite More Tourist
Six	Opportunity to Voice Opinion
Seven	Promote Sports Activities; and Encourage Plant Cultivation

The majority of the respondents highlights the importance of active involvement by the community as well as other relevant people. An active participation would assist in promoting and enhancing the community activities. Other than that, encouragement and awareness campaign is identified as a significant method to increase community involvement.

## CONCLUSION

The paper discusses the identifying the level of community involvement at Kg. Kuala Telang Kuala Lipis. Through the assessment, it is discovered that the local people understand the importance of community involvement as significant ways to preserve the traditional cultural activities at their places. Nevertheless, the causes of the lack of participation are currently occurring, and the need to overcome as well as suggestions to improve the situation is highlighted in the paper as a method to address the problem. In addressing the importance of a community involvement, the respondent's underlined support and encouragement are the keys to ensure the participation of the local people. Besides, the community emphasises the need to provide a platform for them to learn and gain experience in continuing the community activities. The process is observed as a positive approach in encouraging local people to get involved in the community activities.

## ACKNOWLEDGEMENT

This paper is part of a studio project for a second-year Landscape Architecture student in International Islamic University Malaysia (IIUM).

## REFERENCES

- Abdullah, M. (2011). *Concept of equality in Islam*. Available at [www.islam.net](http://www.islam.net)
- Abu Sadat, N. (2008). Globalization as a challenge to Islamic cultural identity. *The Journal of Interdisciplinary of Social Science*, 2(6), 45-52.
- Bakar, A. A., Osman, M. M., & Bachok, S. (2012a). Community involvement in cultural activities: Theories and concept. *1<sup>st</sup> Islamic Built Environment Conference: Proceedings of the IBECNF 2012*. Universitas Islam Bandung, Bandung, Indonesia.
- Bakar, A. A., Osman, M. M., & Bachok, S. (2012b). Measuring community involvement in cultural activities: Case study of Malacca, Malaysia. *National Conference of Postgraduate Research: Proceedings of the NCON-PGR 2012*. Universiti Malaysia Pahang, Pekan, Pahang.
- Beel, D. E., Wallace, C. D., Webster, G., Nguyen, H., Tait, E., Macleod, M., & Mellish, C. (2017). Cultural resilience: The production of rural community heritage, digital archives and the role of volunteers. *Journal of Rural Studies*, 54, 459-468.
- Carli, L. L. (2001). Gender social influence. *Journal of Social*, 57, 725-741.
- Corcoran, M., P. (2002). Place attachment and community sentiment in marginalized neighborhoods: A European case study. *Canadian Journal of Urban Research*, 11, 201-221.
- Firmansyah, F., & Fadlilah, K. U. (2016). Improvement of involvement society in the context of smart community for cultural heritage preservation in Singosari. *Procedia - Social and Behavioral Sciences*, 227, 503-506.

- Frank, S. A., & Lewis, G. B. (2004). Government employees working hard or hardly working? *American Review of Public Administration*, 4(1), 36-51
- Garnett, K., Cooper, T., Longhurst, P., Jude, S., & Tyrrel, S. (2017). A conceptual framework for negotiating public involvement in municipal waste management decision-making in the UK. *Waste Management*, 66, 210-221.
- Lewicka, M. (2008). Place attachment, place identity and place memory: Restoring the forgotten city past. *Journal of Environmental Psychology*, 28, 209-231.
- Manzo, L. C., & Perkins, D. D. (2006). Finding common ground: The importance of place attachment to community participation and planning. *Journal of Planning Literature*, 4, 20-335.
- Moliner, O., Sales, A., & Sanahuja, A. (2017). Social mapping in the context of a community-build day: Strategy to strengthen links with community in a small rural school. *Procedia - Social and Behavioral Sciences*, 237, 305-310.
- Omar, D., Omar, K. A., Othman, S., & Yusoff, Z. M. (2016). Youth participation in urban neighbourhood community. *Procedia - Social and Behavioral Sciences*, 234, 309-316.
- Richwine, J. (2012, September 11). Government Employees Work Less than Private Sector Employees. Retrieved from <https://www.heritage.org/jobs-and-labor/report/government-employees-work-less-private-sector-employees>
- Schmid, H. (2003). *Do women and men really live in different culture? Evidence from the BNC*. Frankfurt: LMU Munchen
- Smeets, R. (2003). *Intangible cultural heritage and its link to tangible cultural and natural heritage*. Available at [www.jpff.go.jp](http://www.jpff.go.jp).
- Smith, L. (2006). *Cultural heritage: Critical concepts in media and cultural studies*. New York: Routledge.
- Smith, L., & Akagawa, N. (2009). *Intangible Heritage*. New York: Routledge.
- Tuan, Y. (1977). *Space and place: The perspective of experience* Minneapolis. Minneapolis: University of Minnesota Press.
- UNESCO (2003). *Implementing the convention for the safeguarding of intangible cultural heritage*. Available at [www.unesco.org](http://www.unesco.org)
- Whelan, S., Tellez, L., O'Brien, M., & Fragoso, M. (2008). Marriage and the public good: Ten principles. Available at [www.winst.org](http://www.winst.org).



**PLANNING MALAYSIA:**  
*Journal of the Malaysian Institute of Planners*  
**VOLUME 16 ISSUE 2** (2018), Page 256 - 265

## **THE RELATIONSHIP BETWEEN LEARNING SPACE ATTRIBUTES WITH STUDENTS' SATISFACTION AND PERCEIVED PERFORMANCE**

**Fadhlzil Fariz Abdul Munir<sup>1</sup>, Asniza Hamimi Abdul Tharim<sup>2</sup>, Thuraiya  
Mohd<sup>3</sup>, & Suzana Said<sup>4</sup>**

<sup>1,2,3,4</sup> *Faculty of Architecture, Planning and Surveying*  
UNIVERSITI TEKNOLOGI MARA, MALAYSIA

### **Abstract**

The shift in the learning patterns of the current generation motivates the changes in the setting of learning spaces. This research objective is to examine the association between Learning Space attributes with student satisfaction and perceived performance. A survey was conducted in Universiti Teknologi MARA (UiTM), Perak Branch, Seri Iskandar Campus, Malaysia. A questionnaire was administered and collected from 410 students, where respondents were asked to select their preferences based on a five-point Likert scale of agreement and satisfaction. The analysis was conducted using PLS-SEM: Smart-PLS Version 3.2 to examine the measurement and structural model of the research. Results indicated that there is a significant relationship between Learning Space attributes with student satisfaction and perceived performance. The overall findings of this research show that the research variables successfully predicted the model.

**Keyword:** learning space, environment, design, facilities, satisfaction, performance

<sup>2</sup>Lecturer at Universiti Teknologi Mara. Email: asnizahamimi@gmail.com

## **INTRODUCTION**

Educators and students have gained the benefits of learning spaces. It discusses on more accurate dimensioning of spaces using the correct tools and equipment (Lomas & Oblinger, 2006; Montgomery, 2008; Oblinger, 2006). In the University, learning space is divided into two different types of environment that are traditional (formal) and non-traditional (informal) (Whiteside, Brooks, Walker, 2010). Many researchers define formal learning as a well-organised environment while informal learning as an environment that is not structured (Andreatos, 2007; Hall, 2009; Malcolm, Hodgkinson, & Colley, 2003; Marsick, & Watkins, 2001; Schugurensky, 2000).

### **Learning Space: Environment, Design and Facilities**

According to Cambridge dictionary, the environment can be defined as the conditions that you live or work in and the way that they influence how you feel or how efficiently you can work. Temple (2007), and Higgins, Hall, Wall, Woolner and McCaughey (2005) describe the specifics of environmental conditions impact on student learning. The environmental conditions discussed are factors such as temperature, noise, lighting, and ventilation (Higgins et al., 2005; Keep, 2002; Lackney & Jacobs, 2002). Physical environment such as lighting, temperature, air quality, noise, and space organization influence students' satisfaction which relate to students' performance.

As stated in Oxford dictionary, design is defined as a plan or drawing produced to show the look and function or working of a building, garment, or other object before it is made. Researchers highlighted that occupant satisfaction is affected not only by indoor environmental parameters but also by workspace and building features, such as the view, control over the indoor environment, amount of privacy as well as layout, size, cleanliness, aesthetics and office furniture (Bluyssen, Aries, & van Dommelen, 2011; Choi, Aziz, & Loftness, 2009; Marans & Yan, 1989; Schakib-Ekbatan, Wagner, & Lussac, 2010; Veitch, Charles, Farley, & Newsham, 2007). The design factors of a building and its uses consist of several modules. The modules are building features, background of the occupants, location and description of workspaces, availability of space, office layout, visual privacy, ease of interaction, furnishings, colours and textures, and visual privacy (Zagreus, Huizenga, Arens, & Lehrer, 2004). Fister (2009) claimed that comfortable furniture and warm colours are the most important features of learning space. Thus, it can be concluded that the characteristic of space design comprises of layout, furniture, colours and textures

As specified in Oxford dictionary, the facility is defined as a place, amenity, or a piece of equipment provided for a particular purpose. The concept of the physical learning environment concerning physical structures relates to spaces, equipment and tools within the learning space (Lehtinen, 1997). Cleanliness and maintenance are also one of the facility characteristics.

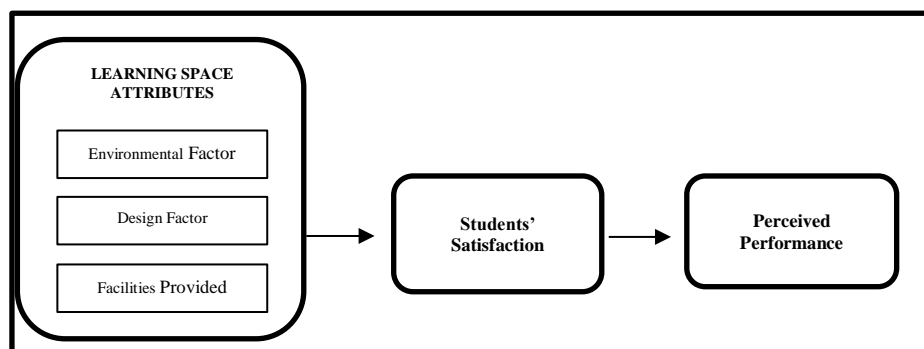
Additionally, access to food is one of the most important features of learning space for students (Fister, 2009). Therefore, it is concluded that facilities consist of tools, equipment, cleanliness, access to food and beverage.

### **Learning Space: Satisfaction and Perceived Performance**

Researchers found that increased satisfaction lead to improved performance (Lehtinen, 1997; Organ, 1977; Schwab & Cummings, 1970). Oblinger (2006) highlighted that the brilliant outcome produced by the students partly depends on the better spaces and tools provided to them. Therefore, it is vital to know what they need beforehand in completing a task. Students' satisfaction influences their learning performance.

### **HYPOTHESIS AND RESEARCH MODEL**

Figure 1 portrays the conceptual research model for this research. It is theorized that there are factors of three learning space influencing students' satisfaction that relate to students' performance in an academic building. These factors include; (i) Environmental Factor, (ii) Design Factor and (iii) Facilities Provided.



**Figure 1:** Conceptual research model

This research proposes four hypotheses which are as follows:

H1. Environmental Factor in a learning space has a positive relationship with Students' Satisfaction

H2. Design Factor in a learning space has a positive relationship with Students' Satisfaction

H3. Facilities provided in a learning space has a positive relationship with Students' Satisfaction

H4. Students' Satisfaction has a significant positive influence on Perceived Performance.



**RESEARCH METHODOLOGY**

This research applies analytic survey using cross-sectional research design. The survey was conducted to determine the relationship between learning space attributed to students’ satisfaction and perceived performance in UiTM Perak Branch, Seri Iskandar Campus. Data was gathered through a set of structured questionnaires distributed to the students. The sample was selected from the students of Faculty of Architecture, Planning and Surveying (FSPU), and Faculty of Art and Design (FSSR) (Semester: September 2017 – Jan 2018) with the total population (N) 8,039 students. This research utilised random sampling technique where a group of respondents is randomly selected from a studied population. The number of sample required was calculated using Slovin’s formula. The methods are as follows:

Total population FSPU (N) = 6,574 students

Total population FSSR (N) = 1,465 students

Formula =  $n = N / (1 + N e^2)$

Confidence level 95% (a margin of error of 0.05) or confidence level 97% (a margin of error of 0.03)

Plug the data into the formula:  $n = N / (1 + N e^2)$

N = Total population; e = margin of error

<p>Calculation 1</p> $\frac{8039}{1 + 8039 (0.0009)} = 1100$	<p>Calculation 2</p> $\frac{8039}{1 + 8039 (0.0025)} = 399$
--	---

The total sample size in this research range from 399 to 1100. For this research, a total sample size of N=400 was sufficient with confidence level 97% and margin of error of 0.03.

The survey questionnaires used in this research consists of two main sections: Respondent Profile (Section 1) and Students’ Perception on Learning Space (Section 2). The second section of the questionnaire is divided into five parts where Part A, B and C emphasis on the independent variable (IV) of this research, which are Environmental Factor (Part A), Design Factor (Part B) and Facilities Provided (Part C). While Part D focuses on the aspect of students' satisfaction as the indirect variable between the independent variable and the dependent variable of the research. Finally, Part E inquires on the students' perceptions towards their performance in relation to their satisfaction level towards the learning space. All items in Section 2 of the questionnaire survey were adapted and modified from previous research on indoor environmental quality (IEQ) (Abdul Tharim, Abdul Samad, & Ismail, 2017) and also taken from different literature on satisfaction research.

## RESULTS

The items in the second section of the questionnaire were measured using a 5-item scale and were analysed using SPSS 22 and Smart-PLS 3.2. Table 1 portrays that most of the respondents prefer hostel (65.5%) as their favourite informal learning space and studio (35.6%) as the most favourite formal learning space. Hence, the results show that respondents preferred informal learning space compared to formal. The majority of the respondents (96%) agreed on the importance of learning space in an institution.

**Table 1:** Demographic profile of the respondent

<b>Description</b>	<b>Percentage (%)</b>	<b>Description</b>	<b>Percentage (%)</b>
<b>Age</b>		<b>Informal Learning Space</b>	
>18-21	74.3	-Campus Cafeteria	14.8
>21-23	24.4	-Fast Food Restaurant	15.3
>23	1.3	-Musolla/ Mosque	4.4
<b>Gender</b>		-Hostel/ Home	65.5
-Female	63.4	<b>Formal Learning Space</b>	
-Male	36.6	-Library	29.4
<b>Research Mode</b>		-Classroom	30.4
-Diploma	75.8	-Studio	35.6
-Bachelor Degree	24.2	-Lab	4.7
<b>Research Year</b>		<b>Favourite Learning Space</b>	
-Year 1	15.1	-Informal	56.1
-Year 2	40.3	-Formal	43.9
-Year 3	38.4	<b>The Importance of Learning Space</b>	
-Year 4	6.2	-Yes	96.9
<b>Faculty</b>		-No	3.1
-FSPU	80		
-FSSR	20		

### Measurement Model Analysis

Table 2 summarizes the results of the measurement model of the research after a few adjustments were made. The overall model consists of 27 items: seven items for Environmental Factor, six items of the Design Factor, and nine items for Facilities Provided. A total of six items were deleted from environmental factor section, and one item from facilities provided to increase the composite reliability

of the independent variable. As for the Students' Satisfaction, which is an indirect variable of the model; all four items measuring the variable were maintained. Perceived Performance is the last dependent variable of the model. The original three items were reduced to a single item measurement to increase the reliability of the dependent variable. Results of the model are illustrated in Figure 2.

**Table 2:** Measurement model analysis results

Construct	Item	Convergent Validity		Internal Consistency Reliability		Discriminant Validity	
		Cross Loading	AVE	Cronbach Alpha	Composite Reliability	HTMT	VIF
		>0.50	>0.50	0.60-0.90	0.60-0.90	Confidence Interval Does Not Include 1	<5.00
Environmental Factor (EF)	7	0.664-0.780	0.526	0.849	0.886	Yes	1.279
Design Factor (DF)	6	0.772-0.832	0.623	0.878	0.908	Yes	1.740
Facilities Provided (FP)	9	0.541-0.804	0.508	0.877	0.902	Yes	1.588
Satisfaction (SAT)	4	0.823-0.859	0.716	0.868	0.910	Yes	1.000
Performance (PER)	1	1.000	1.000	1.000	1.000	Yes	

Table adapted from Hair, Hult, Ringle, & Sarstedt (2014)

\*AVE: Average Variance Extracted; HTMT: Heterotrait-Monotrait Ratio; VIF: Collinearity Statistics

Reliability of the measurement model was measured using Cronbach's Alpha coefficient (> 0.6) to assess the inter-item consistency and Composite Reliability (> 0.7) (Fornell & Larcker, 1981). Table 2 shows that the Cronbach Alpha ranged from 0.849 to 1.000 and the Composite Reliability ranged from 0.886 to 1.000. The values proved that the items were consistent.

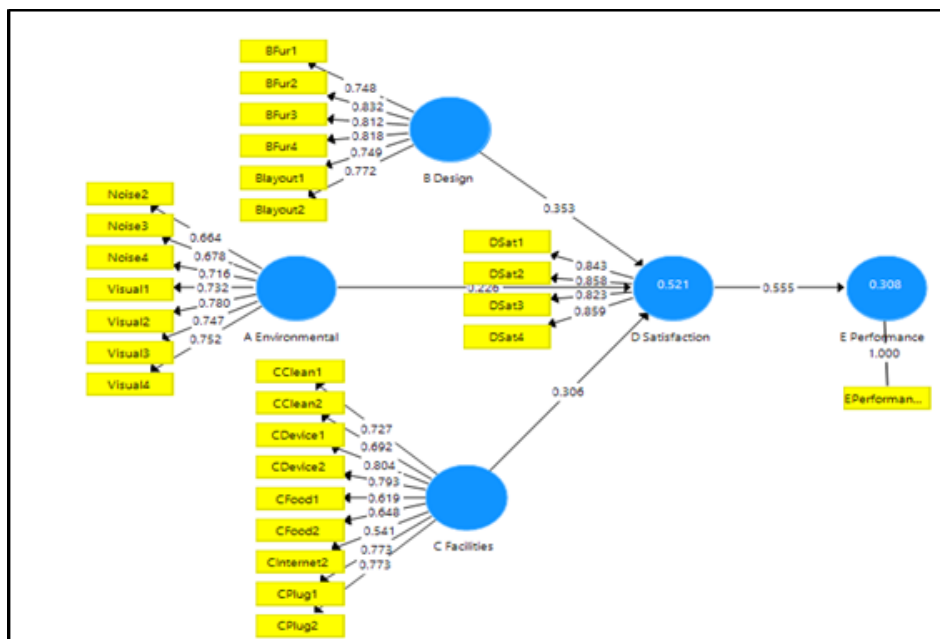


Figure 2: Structural model

The primary purpose of validity test is to measure the fitness of the designed test (Sekaran & Bougie, 2013). The validity of the measurement model is tested using convergent validity and discriminant validity. Convergent validity can be assessed through the factor loadings, composite reliability and average variance extracted (AVE) (Hair et al., 2014). Table 2 shows that the factor loading of each item in the construct exceeded the endorsed value of 0.5 (Hair et al., 2014). Additionally, the value of composite reliability of the model ranged from 0.886 to 1.000. Hence surpassed the recommended value of 0.7 (Hair, Black, Barin, & Anderson, 2010). The AVE values which ranged from 0.508 to 1.000 also exceeded the endorsed value of 0.5 (Fornell & Larcker, 1981; Hair et al., 2014; Barclay, Higgins, & Thompson, 1995). The values indicate the overall amount of variance in the items for the latent construct. Therefore, the result for convergent validity is acceptable for the measurement model.

The discriminant validity of the measurement model is indicated by the weak correlation between items between different constructs (Cheung & Lee, 2010). Discriminant validity is identified by looking at the collinearity statistic of the Variance Inflation Factor (VIF) of the constructs. Table 2 shows that all constructs in the model obtain VIF values of less than 5. Therefore, there are no collinearity issues between the constructs. To further examine the status of discriminant validity, it is best to assess the measurement model in PLS-SEM (Henseler, Ringle, & Sarstedt, 2014). The HTMT criterion value is used to

confirm that the items across the constructs measure different constructs in the model. The confidence interval value of HTMT statistic must not comprise the value of 1 for an entire combination of the construct (Hair et al., 2014). Table 3 shows that HTMT values of the entire construct is less than 0.90 which indicates minimal discriminant validity for the model.

**Table 3:** Heterotrait-Monotrait Ratio (HTMT)

Variables	EF	DF	FP	SAT	PER
Environmental Factor (EF)					
Design Factor (DF)	<b>0.519</b>				
Facilities Provided (FP)	0.402	<b>0.684</b>			
Satisfaction (SAT)	0.574	0.729	<b>0.674</b>		
Performance (PER)	0.389	0.495	0.514	<b>0.595</b>	

### Structural Model Analysis

To test the hypotheses of the research, a structural model was tested and analyzed where all variables hypothesized to influence Student's Satisfaction with Learning Space were significant where the p-value is less than 0.05:

- **Hypothesis 1,2 & 3** – Students' Satisfaction on Learning Space provided at UiTM Perak is influenced directly by Environmental Factor ( $t = 5.609$ ;  $p 0.000$ ), Design Factor ( $t = 6.621$ ;  $p 0.000$ ), and Facilities Provided ( $t = 6.839$ ;  $p 0.000$ ). Therefore, only hypothesis  $H_1$ ,  $H_2$  and  $H_3$  are supported.
- **Hypothesis 4** – There is a positive significant relationship between Students' Satisfaction and Perceived Performance. In other words, Students' Satisfaction has a strong direct influence on Perceived Performance. Results from the path analysis indicates significance level at ( $t = 13.408$ ;  $p 0.000$ ).

A  $Q^2$  value larger than zero in the cross-validated redundancy measures indicate that the exogenous constructs have predictive relevance for the endogenous constructs under consideration. In this study, the value of the  $Q^2$  for Students' Satisfaction (0.342) and for Perceived Performance (0.299), which is well above zero, indicating the predictive relevance of the PLS path model.

### CONCLUSION

This research tested a conceptual framework model based on the learning space satisfaction literature. The instrument used in this study fulfilled the acceptable requirements of the reliability and validity analyses. The outcome of the path model analysis has confirmed that Learning Space attributes of Environmental Factor, Design Factor and Facilities Provided are significantly correlated with Students' Satisfaction and Perceived Performance in Universiti Teknologi MARA, Perak Branch, Seri Iskandar Campus.

## REFERENCES

- Abdul Tharim, A. H., Abdul Samad, M. H., & Ismail, M. (2017). Relationship between indoor environmental quality (IEQ), occupant's satisfaction and productivity in GBI rated office building using SEM-PLS. *Pertanika Journal of Social Sciences & Humanities*, 25S, 319-329.
- Andreatos, A. (2007). Virtual communities and their importance for informal learning. *International Journal of Computers, Communications & Control*, 2(1), 39-47.
- Barclay, D., Higgins, C., & Thompson, R. (1995). The Partial Least Squares (PLS) approach to causal modeling: Personal computer adoption and use as an illustration. *Technology Study*, 2(2), 285-309.
- Bluyssen, P. M., Aries, M., & van Dommelen, P. (2011). Comfort of workers in office buildings: The European HOPE project. *Building and Environment*, 46, 280-288.
- Cheung, M. K. & Lee, K. O. (2010). A Theoretical Model of Intentional Social Action in Online Social Networks. *Decision Support Systems*, 4(1), 24-30.
- Choi, J. H., Aziz, A., & Loftness, V. (2009). *Decision support for improving occupant environmental satisfaction in office buildings: The relationship between sub-set of IEQ satisfaction and overall environmental satisfaction*.
- Fister, B. (2009). The glorious study hall: how libraries nurture a life of the mind. *Library Issues*, 30(2), 1-4.
- Fornell, C., & Larcker, D.F. 1981. Evaluating structural equation models with unobservable variables and measurement error. *Journal of Marketing Research*, 18, 39-50.
- Hair, J. F., Black, W. C., Barin, B. J., & Anderson, R. E (2010). *Multivariate data analysis*. Pearson.
- Hair, J. F., Hult, G. T., Ringle, C. M., & Sarstedt, M. (2014). *A primer on partial least squares structural equation modelling (PLS-SEM)*. London: Sage.
- Hall, R. (2009). Towards a fusion of formal and informal learning environments: The impact of the read/write web. *Electronic Journal of e-Learning*, 7(1), 29-40.
- Henseler, J., Ringle, C.M., & Sarstedt, M. (2014). A new criterion for assessing discriminant validity in variance-based structural equation modeling. *Journal of the Academy of Marketing Science*, 43(1), 115-135.
- Higgins, S., Hall, E., Wall, K., Woolner, P., & McCaughey, C. (2005). *The impact of school environments: A literature review*. Newcastle: University of Newcastle.
- Keep, G. D. (2002). Buildings that teach. *Educational Facilities Planner*, 37(2), 18-22.
- Lackney, J. & Jacobs, P. (2002). *Teachers as placemakers: Investigating teachers' use of the physical learning environment in instructional design*.
- Lehtinen, E. (1997), *Verkkopedagogiikka*. Helsinki: Edita.
- Lomas, C. & Oblinger, D. (2006). Student practices and their impact on learning spaces. In D. Oblinger (Ed.), *Learning spaces* (pp. 5.1-5.11). Washington, DC: EDUCAUSE.
- Malcolm, J., Hodkinson, P., & Colley, H. (2003). The interrelationships between informal and formal learning. *Journal of Workplace Learning*, 15(7/8), 313-318.

- Marans, R.W. & Yan, X. (1989). Lighting quality and environmental satisfaction in open and enclosed offices. *Journal of Architectural and Planning Research*, 6, 118-131.
- Marsick, V. J., & Watkins, K. E. (2001). Informal and incidental learning. *New Directions for Adult and Continuing Education*, 2001(89), 25-34.
- Montgomery, T. (2008). Space matters: Experiences of managing static formal learning spaces. *Active Learning in Higher Education*, 9, 122-138.
- Oblinger, D. (2006). Space as a change agent. In D. Oblinger (Ed.), *Learning spaces* (pp. 1.1-1.4). Washington, DC: EDUCAUSE.
- Organ, D. W. (1977). A reappraisal and reinterpretation of the satisfaction-causes-performance hypothesis. *The Academy of Management Review*, 2(1), 46-53.
- Schakib-Ekbatan, K., Wagner, A., & Lussac, C. (2010, April). Occupant satisfaction as an indicator for the socio-cultural dimension of sustainable office buildings - development of an overall building index. *Adapting to Change: New Thinking on Comfort*. April 9-11, 2010, Windsor, UK.
- Schugurensky, D. (2000, October). The forms of informal learning: Towards a conceptualization of the field. *New Approaches for Lifelong Learning (NALL) Fourth Annual Conference*. October 6-8, 2000. <http://hdl.handle.net/1807/2733>.
- Schwab, D. P. & Cummings, L. L. (1970). Theories of performance and satisfaction: A review. *Industrial Relations*, 9(4):408-30
- Sekaran, U. & Bougie, R. 2013. *Research methods for business: A skill- building approach*. New York: John Wiley & Sons, Inc
- Temple, P. (2007). *Learning spaces for the 21st century: A review of the literature*. London: University of London.
- Veitch, J. A., Charles, K. E., Farley, K. M. J., & Newsham, G. R. (2007). A model of satisfaction with open-plan office conditions: COPE field findings. *Journal of Environmental Psychology*, 27, 177-189
- Whiteside, A., Brooks, D. C., & Walker, J. D. (2010). *Making the case for space: Three years of empirical research on learning environments*. Retrieved from <http://www.educause.edu/ero/article/making-case-space-three-years-empirical-research-learning-environments>
- Zagreus, L., Huizenga, C., Arens, E. A., & Lehrer, D. (2004). Listening to the occupants: A web-based indoor environmental quality survey. *Indoor Air*, 14(Suppl. 8), 65-74.



## **HOUSING FOR DISABLED PEOPLE: WHAT DO THEY NEED?**

**Syakir Amir Ab Rahman<sup>1</sup>, Nasriah Samsudin<sup>2</sup>, Mariana Mohamed Osman<sup>3</sup>, Syahriah Bachok<sup>4</sup>, & Noor Suzilawati Rabe<sup>5</sup>**

<sup>1,2,3,4,5</sup>*Kulliyyah of Architecture and Environmental Design*  
INTERNATIONAL ISLAMIC UNIVERSITY MALAYSIA

### **Abstract**

Across the world, people with disabilities, advocacy companies, key non-authorities and government stakeholders are trying to find approaches to enhance housing assist preparations for the disabled people. In order to do so, the housing industry should be more adaptive to meet the demand of the people with special needs. The government also needs to plan for suitable housing policies for all groups of people. Housing is the central focus for human being including the disabled people and houses that follow housing standard for the disabled will improve their quality of life. The objective of this paper is to study the preferences in terms of price, location and design factors in owning a residential property among the disabled community in Kuala Lumpur and Selangor. A survey questionnaires was distributed to 400 respondents of the disabled community. The survey focused on two categories of disability, which are the physical disability and visual impairment. The outcome of this study describes the preferences in owning a residential property in term of price, location and design of the property. Recommendation was then made on housing strategy in planning for the price, location and design of residential property for the disabled community in Kuala Lumpur and Selangor.

**Keyword:** disabled community, residential property, house price, location, universal design, home ownership, preferences

<sup>1</sup>Assistant Professor at International Islamic University Malaysia. Email: syakiramir@iium.edu.my



## **INTRODUCTION**

Home ownership or the ability to own residential property has been a goal for every Malaysian including the disabled communities. According to Coates, Anand and Norris (2015), owning a residential property provides a sense of security which leads to happiness, productive and fulfilling of one's life. Each person in this world deserves to have a proper living place regardless of their physical disabilities. Therefore, it is important to have some standards of housing that fulfill the needs of disabled people.

El Gibbs (2016) states that the disabled people like any other human beings need affordable and accessible house, safe and secure house, and a house close to services and job opportunities. El Gibbs (2016) also asserts that the disabled people need a place to dwell, a place to call home, a place to entertain guests, a place to spend time with the people they love, and a place to feel safe and secure.

## **PEOPLE WITH DISABILITY**

Persons with Disabilities Act 2008 (Act 685) (Malaysia) defines a person with disabilities (PwDs) as those who have long-term physical, mental, intellectual or sensory impairments which in interaction with various barriers may hinder their full and effective participation in society. The Act also specifies seven categories of PwDs which are visually impaired, hearing impaired, lack of physical effort, learning issue, speech disabilities, mental disabilities and less effort wide.

## **DISABLED COMMUNITY IN MALAYSIA**

There are 356,677 PwDs registered in Malaysia as of 2015 (JKM, 2016a). However, as the registration is voluntary, the statistics is not completely reflective of the actual numbers in the country.

**Table 1:** Registration of person with disabilities (PwDs), 2013 -2015

<b>Year</b>	<b>Number of cases</b>
2013	264,448
2014	318,132
2015	365,677

*Source: JKM (2016a)*

Based on Table 1, the number of registered PwDs increased from year 2013 to year 2015. Based on the total 365,677 registered PwDs in 2015, the total PwDs in Malaysia made up 1.2% of the total population in Malaysia.

**Table 2: Registration of Person with Disabilities (PwDs) by State, 2015**

<b>States</b>	<b>Number of cases</b>
Johor	45,953
Kedah	32,983
Kelantan	25,947
Melaka	18,391
Negeri Sembilan	17,273
Pahang	21,946
Perak	33,020
Perlis	4,404
Pulau Pinang	22,094
Sabah	22,806
Sarawak	25,037
Selangor	55,594
Terengganu	18,281
W.P Kuala Lumpur	20,911
W.P. Labuan	1,037
<b>Total</b>	<b>365,677</b>

Source: Source: JKM (2016a)

Table 2 shows the number of registered disabled community in Malaysia by states. Selangor has the highest registered number of PwDs (55,594) while Kuala Lumpur has 20,911 registered PwDs.

### **HOUSING PRICE FOR THE DISABLED**

The price of purchasing a house is an important matter for everyone regardless their abilities. Price of the house also relates to the access to the loan. Credit facilities or finance can be a factor in encouraging and discouraging in addition to offering a property land (Wurtzebach, Cannon, & Miles, 1995). Currently, the personal loan for buying a house is only provided for the normal people and there is no special loan provided for the disabled people to buy a house.

### **LOCATION OF HOUSE FOR THE DISABLED**

The location factor plays an important role in influencing the property market of residential land. Strategic location with good features, equipped with infrastructure of modern and comfortable living quarters are attractive to the buyers. Another important feature include a location that is closely linked to the development of environment, accessibility and infrastructure facilities.

For the disabled community, the location is an important factor in purchasing a house. The house must be near to easy-access facilities that ease the PwDs to move around with minimum supervision. Weintraub (2017) mentions that the location of the house should be:

- i. Close to work/school;
- ii. Strategic location of local amenities;

- iii. Have scenic views;
- iv. Near to entertainment and shopping area; and
- v. Near to public transport routes.

### **DESIGN OF HOUSE FOR THE DISABLED**

Universal homes incorporate universal design principles, resulting in a living environment that can, with little difficulty and expense, be adapted to virtually any user's long-term comfort, safety and ease. Among the characteristics of the barrier-free adaptable housing are:

- i. It allows free access to buildings, housing units and services for people with mobility, hearing or vision limitations;
- ii. It provides adequate turning and working space for wheelchairs in housing units and public spaces;
- iii. It improves the safety for people to be engaged in normal daily activities;
- iv. It provides features that increase safety in emergencies; and
- v. It provides features that make it easier to use and maintain the building, dwelling units and equipment.

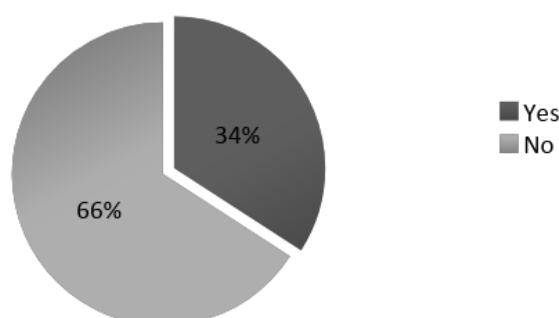
### **METHODOLOGY**

Data was obtained through questionnaire survey. Sample was selected using purposive sampling. The survey focuses on two categories of disabilities which are physically and visually impaired. This selection was due to the reason that about 90% of the worlds' visually impaired live in low-income settings (Krahn, 2011). Additionally, 28% of 25-to-64-year-olds with severe physical disabilities fall far below the federal poverty line - nearly four times the rate for people of the same age who are not disabled (Reed Karaim, 2002). The questionnaires were distributed to 400 respondents from various organization of physical and visual impaired people in Kuala Lumpur and Selangor.

### **FINDINGS AND ANALYSIS**

#### **House ownership**

Figure 1 shows the percentage of disabled community who own a house. From the total of 400 respondents, only 34% or 136 respondents own a house, while 66% of respondents do not own a house.



**Figure 1:** Percentage of home ownership  
 Source: Questionnaire survey, January- April 2017

### Price Factor

The purpose of knowing the current house price and preferred house price is to examine what is the current range of housing price that the disabled people have purchased and what is the actual range of housing price that they can afford or preferred based on their income.

**Table 3:** Current and preferred house price

Price Range	Current house price	Preferred house price
Below RM50,000	40	127
RM50,000-RM100,000	51	145
RM100,001 - RM150,000	29	61
RM150,001 - RM200,000	5	31
RM200,001 - RM250,000	1	4
RM250,001 - RM300,000	2	7
RM300,001 - RM350,000	8	19
RM350,001 - RM400,000	0	1
RM450,001 - RM500,000	0	5
<b>Total</b>	<b>136</b>	<b>400</b>

Source: Questionnaire survey, January- April 2017

From Table 3, it can be seen that the highest frequency of current house price among 51 respondents who owned a house was RM50,000-RM100,000. The highest number of respondents also preferred the same price range. The result shows that the range of current house price was meeting the demand of the preferred range of house price among disabled people.

### Location Factor

Based on Table 4, housing location that is easily accessed by public transport was ranked as the first preferred housing characteristic with mean score

9.43. However, referring to Table 5, the current satisfaction on the location of a house that is easily accessed by public transport was ranked at number 4. This result shows that the current location of house for disabled people are not meeting with the demand.

**Table 4:** Preferred house location

Statement	Mean	Rank
Easily accessed by public transport	9.43	1
Safe neighbourhoods area	9.24	2
Close to workplace and school	9.22	3
Equipped with disabled facilities	9.03	4
Near to public facilities	9.01	5
Near to attractive places	8.89	6

Source: Questionnaire survey, January- April 2017

**Table 5:** Current satisfaction/condition for house location

Statement	Mean	Rank
Near to attractive places	7.26	1
Safe neighbourhoods area	7.25	2
Near to public facilities	7.11	3
Easily accessed by public transport	6.88	4
Close to work place and school	6.58	5
Equipped with disabled facilities	6.35	6

Source: Questionnaire survey, January- April 2017

### Design Factor

Table 6 shows that the respondents preferred a house that is designed to accommodate physical limitations or encourage low physical effort. However, based on Table 7, the design of house that encourages low physical effort was ranked at seventh place. These show that the current house design does not meet the needs and the demand of disabled people.

**Table 6:** Preferred house design

Statement	Mean	Rank
Design of house encourage low physical effort	8.94	1
Elevator is provided for disabled person	8.91	2
Design of washroom is disabled friendly	8.78	3
Complete with ramp to access into building	8.58	4
Handrail is provided	8.55	5
Bathroom is provided at level one or near to main room for disabled	8.51	6
Design of the kitchen is disabled friendly	8.46	7
Have a bedroom designed for disabled person	8.44	8

Source: Questionnaire survey, January- April 2017

**Table 7:** Current satisfaction of house design

Statement	Mean	Rank
Complete with ramp to access into building	5.92	1
Elevator is provided for disabled person	5.65	2
Bathroom is provided at level one or near to main room for disabled	5.62	3
Design of washroom is disabled friendly	5.55	4
Have a bedroom designed for disabled person	5.33	5
Handrail is provided	5.10	6
Design of house encourage low physical effort	5.10	7
Design of the kitchen is disabled friendly	5.02	8

Source: Questionnaire survey, January- April 2017

## RECOMMENDATION AND CONCLUSION

Most of the disabled people could not afford to own a house due to the high prices that are mismatched with their income. Therefore, two recommendations are suggested to resolve this issue.

- i. Provide 'Rent to Own Housing Program'.  
 Federal and state government with related housing agencies should offer and conduct 'Rent to Own Housing Program', where the disabled can have the opportunity to rent selected houses under low-cost housing scheme in Malaysia, for a certain period of time such as five to ten years. Later, if the disabled people have a good record of monthly rental payment and fulfill other requirements, the particular house will automatically be their house.
- ii. Provide 'Help to Buy: Shared Ownership' scheme.  
 This scheme is proposed for disabled people that could not afford to buy the house on their own. It is suggested that the ownership of the house will be shared between the disabled people and local authority.  
 This proposal is one of the initiatives in giving a chance for the disabled people to own a house. It is suggested that this program will involve between two parties, the applicant (the disabled people) and local authority. The applicant may buy a share of the house (between 25% and 75% of the house's value) and pay rent on the remaining share. In time, they could buy bigger shares until the house's share 100% belong to them.  
 The procedure begins with identifying the unit of house that the disabled person proposed to buy, and then he or she can apply for the Help to Buy scheme. Few term and regulation especially on the minimum income should be made and it is targeted that the share only lasts for few years. If the applicant cannot buy the remaining share after certain years,

the local authority will have the right to take the house back and sell to the other potential applicant.

Another finding was the current satisfaction or situation on housing design does not meet the preferences of the disabled people. Therefore, another two recommendations are suggested to resolve this issue.

- i. Provide at least the minimum elements of universal design in all housing unit.

Universal design elements are not only designated for the disabled people, but also for the aging population. Therefore, there is a need for each housing unit in the upcoming housing projects to implement at least the minimum requirement or elements of universal design. The government needs to make this requirement as compulsory to all housing developers and efficiently implement the enforcement. It is to suggest that in specific, the house should at least have unobstructed width of doors with minimum width of 850mm, 900mm or more, provide ramp to access into the house and have toilet that are complete with PwDs facilities such as the level one toilet, suitable toilet seat, foldable grab rail, independent water supply beside toilet seat and wash hand basin at suitable height for wheelchair user.

- ii. Home modification scheme.

Every day, disabled individuals find that their homes need to be modified in a way that gives them easier access. These modifications make it possible for them to stay in their home and live an independent life. Home adjustments come in all shapes and sizes and can vary in cost from one manufacturer and contractor to another. The idea for this proposal is designated for the disabled people that already own a house but need some modification of the house to cater their needs. Among the types of home modifications that can be offered are:

- a. Bathroom and toilets renovations to make them disabled friendly;
- b. Modification of kitchen to be user-friendly for disabled people;
- c. Installation of ramp, grab rails and handrails;
- d. Widening of the doorways; and
- e. Other modification needed by the disabled people.

In conclusion, in planning the housing for the disabled communities, the main characteristics to be considered is the barrier-free design. Referring to the result of the finding, the disabled people would need an affordable house that will encourage the low physical effort. The preferred characteristics of the design of

the house for the disabled have been highlighted. Therefore, it is essential for the related government or housing agencies to learn further from success and failures of other countries to improve the need for the disabled communities by providing related housing policies for the disabled.

## REFERENCES

- Coates, D., Anand, P., & Norris, M. (2015). Housing, happiness and capabilities: A summary of the international evidence and models. *Open Discussion Papers in Economics*, 81.
- El Gibbs (2016). Why the 'problem' of housing for people with disability is one for everyone. Retrieved from <https://croakey.org/cripcroakey-why-the-problem-of-housing-for-people-with-disability-is-one-for-everyone/>
- JKM (2016) *Statistic of registered disabled community in Malaysia*.
- Karaim, R. (2002). *People with physical disabilities*. The United States of America.
- Krahn, G. L. (2011). WHO world report on disability: A review. *Disability and Health Journal*, 4, 141-142.
- Persons with Disabilities Act 2008 (Act 685) (Malaysia)*.
- Weintraub, E. (2017). *What location, location, location means in real estate*. Retrieved from <https://www.thebalance.com/what-location-means-in-real-estate-1798766>.
- Wurtzbaach, C. H., Cannon, S. E., & Miles, M. E. (1995). *Modern real estate*. New York: Wiley.





**PLANNING MALAYSIA:**

*Journal of the Malaysian Institute of Planners*

**VOLUME 16 ISSUE 2** (2018), Page 275 - 284

## **ASSESSMENT ON SITTING POSTURE RELATION TO RISK FACTORS BY USING CHI-SQUARE TEST AMONG ELDERLY TAXI DRIVERS IN PENINSULAR MALAYSIA**

**Ahmad Zuhairi Abdul Majid<sup>1</sup>, Irwan Syah Md Yusoff<sup>2</sup> & Shamsul Bahri Mohd Tamrin<sup>3</sup>**

*<sup>1,2</sup>School of Arts*

UNIVERSITI SAINS MALAYSIA

*<sup>3</sup>Faculty of Medicine and Health Science*

UNIVERSITI PUTRA MALAYSIA

### **Abstract**

There are numerous factors to take into account to ensure the elderly taxi drivers perform well at work while maintaining a good health. This paper is aimed to assess sitting posture of elderly taxi drivers in Peninsular Malaysia using chi-square test. A cross-sectional study was conducted with elderly taxi drivers using a self-administered questionnaire. The survey results deliver details of socio-demographic, work characteristics and sitting comfort of older taxi drivers. Purposive sampling was used targeting at 60 years old and older, self-driving taxi for at least 1 year, no disabilities and registered with Land Public Transport Commission (LPTC). A total of 120 respondents participated in the study. Most of the respondents used 'hired' car (76.7%). More than half of respondents had back pain in the past 12 months and 67.5% felt back pain in the last seven days. There are significant relationships ( $p < 0.05$ ) between discomfort due to seat design and (i) BMI, (ii) smoking status, (iii) driving until midnight, (iv) feeling back pain for the last 12 months and last seven days. The lower body parts are susceptible to musculoskeletal disorders (MSDs) symptom and low back pain (LBP) injuries. Inappropriate sitting posture may cause discomfort and lead to MSDs. The lack of awareness on ergonomics design for sitting comfort lead to poor lifestyle and health issues among elderly taxi drivers in Malaysia.

**Keyword:** chi square, elderly, taxi driver, seating posture, ergonomics

## **INTRODUCTION**

Malaysia's population in the year 2000 was approximately 23.3 million and the number grew each year. It is expected that the aging community to serve their even though after pension as they have acclimated with their previous working environment. Department of Social Welfare Malaysia (DSWM) described people who aged 60 years old and above fall into a category of elderly as referred to "World Assembly On Ageing 1982" in Vienna. Past research indicated that approximately one-third of pensioners are vulnerable to poor retirement and outcomes in term of life satisfactions and well-being (Solinge & Henkens, 2008; Wang, 2007). Therefore, the elderly community tend to find other jobs after pension according to their health and ability. In other case, they tend to work part time jobs to financially support their family or to sustain life in the financially challenging world. It is found that the elderly community prefer to work as taxi drivers after retirement. Driving taxi is considered as manageable job that requires less energy, low cost, no specific requirement (standard licensed) and no specific regulation. It is also an advantage if they have experience in driving on commercial or private car.

Numerous factors should be considered to ensure the elderly taxi drivers could perform well at work and insure their life with good health and safety. The first factor is time. Taxi drivers spend a longer time in driving than other professions (Raanaas & Anderson, 2008; Figà-Talamanca et al., 1996; Dalziel & Job, 1997). The second factor is the practices of lugging of too much baggage weight and sleeping on the car seat during rest breaks (Raanaas & Anderson, 2008). Several occupational factors such as whole-body vibration, long working hours, cramped driving space, shocks due to road surface, total mileage, time employed as a taxi driver, job dissatisfaction and job stress have been found to be important determinants of back pain among taxi drivers (Bovenzi & Zadini, 1992; Chen, Chang, Chang, & Christiani, 2005; Funakoshi, Taoda, Tsujimura, & Nishiyama, 2004). Taxi drivers spend long working hours at road per-day. Excessive driving distance and working hours lead to negative impacts to the elderly taxi drivers. Most of the elderly taxi drivers' physical and mental health are poor. The average working time for taxi drivers are 10.5 hours per day for 6.4 days per week (Yang et al., 2014). Most taxi drivers suffer from the work-related diseases. Taxi drivers have a high risk of disrupting their biological clock and are at risk of body injuries; low back pain, neck disorder, carpal tunnel syndrome, depression, tension, fatigue, insomnia and other diseases (Yang et al., 2014). Other occupational factors such as whole-body vibration, long working hours, cramped driving space, shocks due to road surface, total mileage, job dissatisfaction and job stress have been found to be important determinants of low-back pain among taxi drivers (Bovenzi & Zadini, 1992; Chen et al., 2005; Funakoshi et al., 2004). These occupational factors speed the aging process of taxi drivers and exposed them to more injuries.

Ergonomics is one of the significant factors to be considered in designing a seat. Drivers' seats such as seat pans, seat inclination, sitting without lumbar support and awkward body posture bending during driving were reported in MSDs as causes of lower back pain. According to Kroemer (2017), ergonomics is the application of scientific principles, methods, and data drawn from a variety of disciplines to the development of engineering systems in which people play a significant role. One of the most important contributions that ergonomics can provide to the automobile design process is information of the physical size of driver, and his/her preferred postures (Hirao, Kitazaki, & Yamazaki, 2006). The current awareness on comfort and discomfort is lacking, while the need for this knowledge is crucial since people use products related to comfort everyday (Vink & Hallback, 2012). Many authors have yet to find any study that directly assess the association between awareness of Ergonomics factors and MSD on sitting posture among elderly taxi drivers in Peninsular Malaysia. This paper aims to assess the sitting posture relating to risk factors among elderly taxi drivers in Peninsular Malaysia by using chi-square test.

## **METHODS**

The study employed cross-sectional survey using questionnaires to investigate characteristics of driving background and prevalence of discomfort on sitting posture among elderly taxi drivers in Peninsular Malaysia. The study was conducted at rural and urban areas in four regions of peninsular Malaysia. A purposive sampling was chosen and 120 respondents participated in the study. Sampling criteria include (i) age above 60 years old, (ii) have at least 1 year taxi driving experience, (iii) registered with LPTC, (iv) have no history of major surgery or history of neurological problems. Taxi drivers that attended any courses or training on occupational health and were part-time taxi drivers of less than 4 hours driving per-day were excluded. Types of taxi services involved are the 'budget car' and 'hired' car. Respondents in peninsular Malaysia aging 60 years above driving 'budget car' and 'hired' car with standard seat design. No modification on the seat is involved. Each survey took approximately 10 to 15 minutes to complete. Participants were asked kindly if they agree to take part. A complete survey form would include work characteristics, some health issues of taxi drivers and sitting posture details.

A self-administered questionnaire was distributed to the participants. The interview was conducted face to face with elderly taxi drivers to obtain good result and minimize miss-interpreted responses. The questions were divided into three sections. The first part of the questionnaire is on socio-demographic factors. The second part of the questions are on characteristics and the third part include questions on the body part discomfort map from each body part on the sitting driving position. The questions were adapted from the United States driving ergonomics program. A body discomfort map diagram was used and the diagram

assist the elderly taxi drivers in identifying the correct body parts in answering the questions as shown in Figure 1.

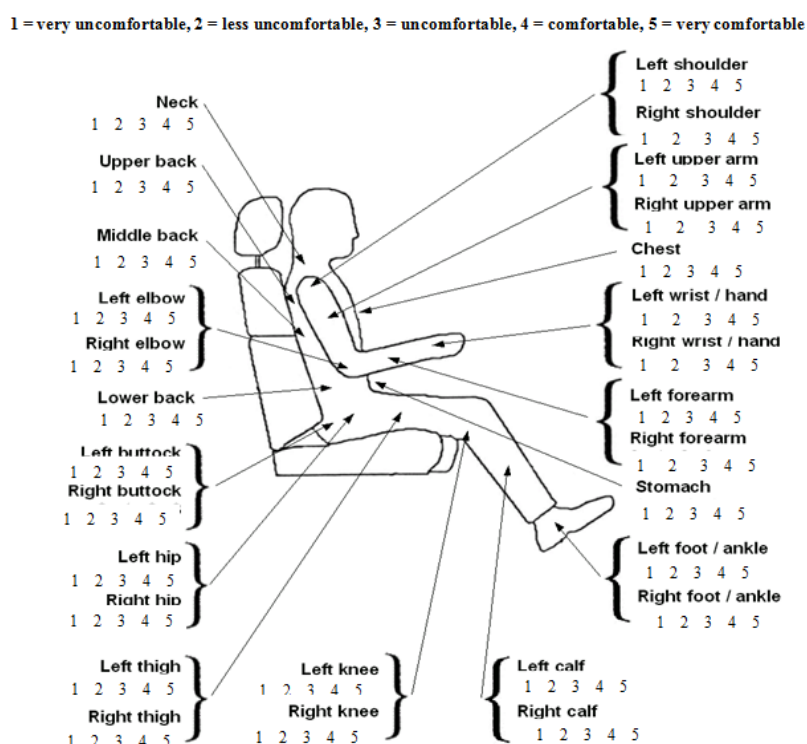


Figure 1: Discomfort body parts maps

Source: Adopted from United States driving ergonomics program

The interview was conducted in parking spaces of bus station, train station, shopping malls and taxi stand areas in Serdang city and Putrajaya. All selected taxi were chosen in this study were registered with SPAD under taxi services that cover the budget and hired car. Besides that, these taxi types were classified as economy taxi and the car seat design underlined in standard/normal specification compared to other taxi services. The analysis was performed using SPSS software version 20. Descriptive statistics were obtained for all the variables in the study.

## RESULTS

The majority of elderly drivers used 'hired car' as a type of taxi (76.7%. All respondents were male. Mean ( $\pm$ SD) age of the respondents was  $64.7 \pm 4.0$  and the age ranged from 60 to 77 years old. Most of elderly taxi drivers aged between 60

to 65 years old (60%). The majority of the respondents were Malay (78.3%) followed by Indian (13.3%). The majority of respondents were self-employed (56.7%). The smoking status were relatively equal between frequent smokers (55.0%) and non-smokers (45.0%) as shown in Table 1.

**Tables 1:** Background of elderly taxi drivers.

<b>Factors</b>	<b>N (%)</b>	<b>Mean ±(S.D)</b>	<b>Min</b>	<b>Max</b>
<b>Category taxi</b>				
Hired car	92(76.7)			
Budget	28(23.3)			
<b>Age</b>		64.7±4.0	60	77
60>65	72(60)			
>66	48(40)			
<b>Ethnicity</b>				
Malay	94(78.3)			
India	16(13.3)			
Chinese	10(8.3)			
<b>Jobs sectors</b>				
Company	52(43.3)			
Self - employed	68(56.7)			
<b>Smoking status</b>				
Yes/frequent	66(55.0)			
No/never	54(45.0)			

N=120

Table 2 shows that 75.8% of the respondents exceeded 250 km driving distance per week. Less than half of the respondents (45.8%) never drove their taxi until midnight while 15.8% of the respondents tend to drive until midnight. 76.7% of the respondents complained having back pain in the last 12 months and 67.5% of the respondents reported feeling back pain in the past 7 days. The taxi drivers agreed that the back pain were caused by their work environment (89.2%). Most of them tend to carry passengers' luggage into the trunks (95.0%). 44.2% of the respondents claimed to have experienced driving taxi for 16 years and more.

**Table 2:** Characteristics of elderly taxi driver

<b>Factors</b>	<b>N (%)</b>
<b>Average distance driving per-week</b>	
51>150km	4(7.5)
151>250km	25(20.0)
>250km	91(75.8)
<b>Driving until mid-night</b>	

Always	19(15.8)
Not frequent	46(38.3)
Never	55(45.8)
<b>Past 12 month feeling back pain</b>	
Yes	92(76.7)
No	28(23.3)
<b>Past 7 days feeling back pain</b>	
Yes	81(67.5)
No	39(32.5)
<b>Feeling back pain cause of job</b>	
Yes	107(89.2)
No	13(10.8)
<b>Carry luggage into trunk</b>	
Yes	114(95.0)
No	6(5.0)
<b>Total driving experience</b>	
1>5 yrs	32(26.7)
6>15yrs	35(29.2)
>16yrs	53(44.2)

The results from Table 3 show that most of the taxi drivers complaint that the highest body part were very uncomfortable. Discomfort body parts include lower back (63.3%), right buttock (62.5%), and left buttock (61.7%). 33.3% of the respondents claimed to experience small discomfort at upper back and center back (32.5%), right thigh (30.8%) and neck (18.3%). Overall, the majority of the respondents (92.5%) agreed that the discomfort of body parts were caused by car seat design.

**Table 3:** Discomfort body map of elderly taxi drivers

Factors	%				
	1	2	3	4	5
Neck	10.8	18.3	35.0	25.8	10.0
Upper back	12.0	33.3	35.8	14.2	4.2
Center back	11.7	32.5	35.8	18.3	1.7
Lower back	23.3	40.0	20.0	15.8	0.8
Left buttock	16.7	45.0	20.8	15.8	1.7
Right buttock	24.2	38.3	23.3	12.5	1.7
Discomfort body part cause of seat design					
Yes	92.5%				
No	7.5%				

N=120

\*Legend

1= very uncomfortable      2=less uncomfortable  
 3= uncomfortable      4= comfortable      5= very comfortable

Table 4 indicates that (i) the discomfort body parts due to seat design, (ii) risk factors, (iii) socio-demographic factors had significant relationship with BMI  $25 \geq 40$  ( $X^2:4.31$ ,  $p: 0.03$ ) and smoking status ( $X^2 = 4.22$ ,  $p = 0.04$ ). Others variables like age, education level and job sectors had no significant relationship with the discomfort body parts due to seat design. Additionally, characteristics of elderly taxi drivers had significant relationship with ‘always driving until midnight’ ( $X^2:5.97$ ,  $p: 0.01$ ), feeling back pain in past 12 month ( $X^2:5.64$ ,  $p: 0.01$ ), feeling back pain in the past 7 days ( $X^2:14.10$ ,  $p: 0.00$ ), feeling back pain due to the job ( $X^2:5.10$ ,  $p: 0.02$ ) and feeling back pain due to carrying luggage into the trunks ( $X^2:16.44$ ,  $p: 0.00$ ). On the other hand, average hours driving per week, average distance driving per week and total driving experience did not contribute to discomfort body posture.

**Table 4:** Risk factors with discomfort body posture on seat design (Chi Square test)

Variables	Discomfort body posture on seat design		Chi Square value ( $X^2$ )	P value
	Yes	No		
<b>BMI</b>			4.31	<b>0.03**</b>
≤15 ≥ 25	43.3	0.8		
25 ≥ 40	49.2	6.7		
<b>Education level</b>			0.11	0.73
Primary & none	35.8	3.3		
Secondary & highest	56.7	4.2		
<b>Jobs sectors</b>			0.59	0.44
Company	39.2	4.2		
Self - employed	53.3	3.3		
<b>Smoking status</b>			4.22	<b>0.04**</b>
Yes/frequent	53.3	1.7		
No/never	39.2	5.8		
<b>Average distance driving per-week</b>			1.82	0.17
≤150km	2.5	0.8		
≥151km	90.0	6.7		
<b>Driving until mid-night</b>			5.97	<b>0.01**</b>
Not frequent & never	80.0	4.2		
Always	12.5	3.3		
<b>Past 12 month feeling back pain</b>			5.64	<b>0.01**</b>
No	19.2	4.2		
Yes	73.3	3.3		
<b>Past 7 days feeling back pain</b>			14.10	<b>0.00**</b>
No	25.8	6.7		
Yes	66.7	0.8		
<b>Feeling back pain cause of job</b>			5.10	<b>0.02**</b>
No	8.3	2.5		
Yes	84.2	5.0		
<b>Carry luggage into boot</b>			16.44	<b>0.00**</b>

No	2.5	2.5		
Yes	90.0	5.0		
<b>Total driving experience</b>			0.22	0.63
<5 years	24.2	2.5		
>5 years & above	68.3	5.0		

N = 120

\*\*Significant  $p < 0.05$

## DISCUSSION

In this study, more than half of the respondents age ranged between 60 to 65 years old. Previous study conducted by Welch, Haile, Boden and Hunting (2009) indicated that low back pain occurs between 30 and 50 years old and cost approximately 30% of expenditure due to soft tissue damaged. According to Pruesser, Williams, Ferguson, Ulmer and Weinstein (1998), taxi drivers that were between 65 and 69 years old were 2.26 times higher at risk of fatal multi-vehicle crash compared to taxi drivers that were between 40 and 49 years old.

In Nigeria, 85% of taxi drivers were engaged in driving business as means of living (Onawumi & Lucas, 2012). The findings showed that almost the same percentage of taxi drivers (85%) were either working full time or self-employed to financially sustain their life and their family.

In addition, the findings revealed that there were significant relationship between discomfort body parts due to seat design and (i) smoking status and (ii) BMI (obese). The result were similar with those reported previously (Al-Dubai, Qureshi, Ismail, & Rampal 2012). The findings were also consistent with another research (Miyamoto et al., 2008) that driving long hours and driving late at night had significant relationships with discomfort body parts due to seat design. The longer time spent daily or weekly to pick up and waiting for passengers lead to back injury (Miyamoto et al., 2008).

76.7% and 67.5% of the respondents claimed to experienced back pain in the past 12 months and in the past seven days respectively. Based on the discomfort body parts map, the highest complaints of discomfort were on back body parts compared to other body parts. Previous research (Chen et al., 2005; Funakoshi et al., 2004) revealed similar findings that prevalence of lower back parts among taxi drivers were 45.8% in Japan and 51% in Taiwan.

The findings of the study indicated that long years of working experience were related to sitting discomfort. Elderly drivers that have 6 years to 15 years driving experiences tend to face discomfort body parts. The previous survey study conducted with professional drivers found a significant association between low back parts and duration of employment as a bus driver (Tamrin et al., 2007). However, some studies on taxi drivers did not find such relationship. Instead, the studies indicated that there was no relationship between years of experiences as taxi drivers and discomfort body parts (Chen et al., 2005).



The study found that years of carrying passengers' luggage into the trunks led to discomfort of body parts. Most of taxi drivers suffer from work-related diseases. The work tend to disrupt their biological clock and often lead to body injuries such as low back pain, neck disorder, carpal tunnel syndrome, depression, tension, fatigue, insomnia and other diseases (Yang et al., 2014).

## **CONCLUSION**

In general, this study deliver the perspectives of elderly taxi drivers on sitting posture. The study identified the risk factors of sitting posture that would lead to injury or pain due to seat design. The findings were helpful in initiating the prevention of MSDs or developing body parts injuries through determining which body part may develop the cumulative injuries. The limitation of the study is the insufficient sample size to represent the population of elderly taxi driver in Peninsular Malaysia. Ergonomics intervention approach would reduce MSD related problems. In an attempt to improve the safety and wellbeing of the elderly community, future studies on the topic is highly encouraged.

## **ACKNOWLEDGEMENT**

We would like to thank to the Malaysian Consumer and Family Economics Association (MACFEA) for providing funds under the Mini Grants MACFEA 2017 scheme to conduct this study. We are also thankful to Universiti Sains Malaysia for the journal publication fund. The contents of this paper are solely the responsibility of the authors and do not necessarily represent the official views of the sponsors.

## **REFERENCES**

- Al-Dubai, S. A. R., Qureshi, A. M., Ismail, N. H., & Rampal, K. G. (2012). Prevalence and determinants of low back pain among taxi drivers in Malaysia. A cross sectional study. *Journal of Advanced Medical Research*, 2(4), 129-43.
- Bovenzi, M., & Zadini, A. (1992). Self-reported low back symptoms in urban bus drivers exposed to whole-body vibration. *Spine*, 17(9), 1048-1059.
- Chen, J. C., Chang, W. R., Chang, W., & Christiani, D. (2005). Occupational factors associated with low back pain in urban taxi drivers. *Occupational Medicine*, 55(7), 535-540.
- Dalziel, J. R., & Job, R. S. (1997). Motor vehicle accidents, fatigue and optimism bias in taxi drivers. *Accident Analysis & Prevention*, 29(4), 489-494.
- Figà-Talamanca, I., Cini, C., Varricchio, G. C., Dondero, F., Gandini, L., Lenzi, A. & Patacchioli, F. R. (1996). Effects of prolonged autovehicle driving on male reproductive function: a study among taxi drivers. *American Journal of Industrial Medicine*, 30(6), 750-758.
- Funakoshi, M., Taoda, K., Tsujimura, H., & Nishiyama, K. (2004). Measurement of

- whole-body vibration in taxi drivers. *Journal of occupational health*, 46(2), 119-124.
- Hirao, A., Kitazaki, S., & Yamazaki, N. (2006). *Development of a new driving posture focused on biomechanical loads* (No. 2006-01-1302). SAE Technical Paper.
- Kroemer, K. H. (2017). *Fitting the human: Introduction to ergonomics/human factors engineering*. Boca Raton: CRC Press.
- Miyamoto, M., Konno, S., Gembun, Y., Liu, X., Minami, K., & Ito, H. (2008). Epidemiological study of low back pain and occupational risk factors among taxi drivers. *Industrial Health*, 46(2), 112-117.
- Onawumi, A. S., & Lucas, E. B. (2012). Ergonomic Investigation of Occupational Drivers and Seat Design of Taxicabs in Nigeria. *ARPJN Journal of Science and Technology*, 2(3), 214-220.
- Preusser, D. F., Williams, A. F., Ferguson, S. A., Ulmer, R. G., & Weinstein, H. B. (1998). Fatal crash risk for older drivers at intersections. *Accident Analysis & Prevention*, 30(2), 151-159.
- Raanaas, R. K., & Anderson, D. (2008). A questionnaire survey of Norwegian taxi drivers' musculoskeletal health, and work-related risk factors. *International Journal of Industrial Ergonomics*, 38(3), 280-290.
- Solinge, H., & Henkens, K. (2008). Adjustment to and satisfaction with retirement: Two of a kind? *Psychology and Aging*, 23, 422-434.
- Tamrin, S. B. M., Yokoyama, K., Jalaludin, J., Aziz, N. A., Jemoin, N., Nordin, R., ... & Abdullah, M. (2007). The association between risk factors and low back pain among commercial vehicle drivers in peninsular Malaysia: a preliminary result. *Industrial Health*, 45(2), 268-278.
- Vink, P., & Hallbeck, S. (2012). Editorial: Comfort and discomfort studies demonstrate the need for a new model. *Applied ergonomics*, 43(2), 271-276.
- Wang, M. (2007). Profiling retirees in the retirement transition and adjustment process: examining the longitudinal change patterns of retirees' psychological well-being. *Journal of Applied Psychology*, 92(2), 455.
- Welch, L., Haile, E., Boden, L. I., & Hunting, K. L. (2009). Musculoskeletal disorders among construction roofers - physical function and disability. *Scandinavian journal of work, environment & health*, 35(1), 56-63.
- Yang, Y., Fan, X. S., Tian, C. H., Zhang, W., Li, J., & Li, S. Q. (2014). Health status, intention to seek health examination, and participation in health education among taxi drivers in Jinan, China. *Iranian Red Crescent Medical Journal*, 16(4), e13355.



**PHYSICOCHEMICAL PROPERTIES AND POZZOLANIC  
PERFORMANCE OF ULTRAFINE TREATED RICE HUSK ASH  
(UFTRHA) AS ADDITIVE IN CONCRETE**

**Siti Asmahani Saad<sup>1</sup>, Nasir Shafiq<sup>2</sup> & Maisarah Ali<sup>3</sup>**

<sup>1,3</sup>*Kulliyyah of Engineering,*  
INTERNATIONAL ISLAMIC UNIVERSITY MALAYSIA  
<sup>2</sup>*Faculty of Engineering,*  
UNIVERSITI TEKNOLOGI PETRONAS, MALAYSIA

**Abstract**

Rice husk ash (RHA) contains high amount of amorphous silica that is ubiquitous in the pozzolanic reaction of SCM in concrete. However, usage of conventional RHA is currently unfavourable in concrete industry due to its properties inconsistency. In this regard, improvement on the RHA properties by introduction of thermochemical pre-treatment prior to burning procedure is seen as an excellent way to reach the goal. In this paper, raw rice husk was pre-treated using 0.1N hydrochloric acid (HCl) and heated at 80°C. It was then mechanically activated by high energy planetary ball mill for 15 minutes at speed of 300rpm and ball-to-powder ratio (BPR) of 15:1. The chemical composition, mineralogical properties, particle size analysis, specific surface area as well as microstructure properties of ultrafine treated rice husk ash (UFTRHA) were determined accordingly. As for amorphous silica content of the optimum sample was recorded as 98.60% incinerated at 600°C with four hours of pre-treatment soaking duration. In terms of particle size and specific surface, it was also observed that, burning temperature of 600°C, pre-treated at four hours were recorded to produce finest size of UFTRHA where d(0.1), d(0.5) and d(0.9) were obtained as 1.416 µm, 4.364 µm and 14.043 µm respectively. Largest specific surface area value was obtained at 219.58 m<sup>2</sup>/g with the similar pre-treatment conditions. Meanwhile, the strength activity of UFTRHA from the optimum pre-treatment process was measured by testing the compressive strength of mortars. The highest compression value obtained was 50.17MPa with 3% UFTRHA replacement at 28 days.

**Keyword:** Ultrafine Treated Rice Husk Ash (UFTRHA), concrete additive material, rice husk ash, physicochemical, high energy grinding

## **INTRODUCTION**

In current research trend, most researchers have promoted green technology application widely. This phenomenon encourages recent explorations of the application of additive materials in concrete industry. Additive materials are commonly used in concrete as admixtures to enhance its properties and also to promote greener concrete production. Rice husk ash (RHA) is regarded as one of concrete additive materials due to its high silica content. Production of RHA is done via thermal activation, which involves burning process of the rice husk from agricultural waste.

Rice plant is a type of plant that has the ability to absorb silica content from soil. The absorbed silica eventually assimilates into the plant structure during its growth. Therefore, the outer part, which is the rice husk, possesses high silica content with value of more than 80% (Juenger & Siddique, 2015). Approximately 1,000 million tons of rice are annually produced in the world, which usually leaves about 400 million tons of rice husks as waste material (Food Agriculture Organization (FAO), 2015). Hence, the potential of producing ash from husk is about 100 million tons per annum. Therefore, utilizing RHA in concrete is possible. Furthermore, high content of amorphous silica and high specific surface area (SSA) of RHA are possible to be achieved by adopting suitable burning condition (Mehta & Monteiro, 2006). Thus, incorporation of RHA in concrete production promotes environmental as well as economic relief. Compared to other additive types such as silica fume (SF) and fly ash (FA), RHA is proven to have greater reaction with portlandite ( $\text{Ca(OH)}_2$ ) in pozzolanic reaction, contributes towards increment in compressive strength value and durability of high performance concrete (Feng, Yamamichi, Shoya, & Sugita, 2004; Salas, Delvasto, de Gutierrez, & Lange, 2009; Van, Rößler, Bui, & Ludwig, 2013) and ultra-high performance concrete as well (Van, Rößler, Bui, & Ludwig, 2014a; . Van, Rößler, Bui, & Ludwig, 2014b; Van Tuan, Ye, Van Breugel, & Copuroglu, 2011; Van Tuan, Ye, Van Breugel, Fraaij, & Bui, 2011).

In order to ascertain high amount of amorphous silica content from rice husk, metal impurities i.e. potassium and magnesium that encapsulate the rice husk surface should be removed. Elimination of these metal impurities is possible through thermochemical pre-treatment process using inorganic acid i.e. hydrochloric acid (HCl) and nitric acid ( $\text{HNO}_3$ ) (Park, Salas, Chung, & Lee, 2014; Salas et al., 2009; Vayghan, Khaloo, & Rajabipour, 2013). The thermochemical pre-treatment process is able to reduce the sensitivity of RHA towards burning temperature (Feng et al., 2004). Therefore, in this paper, the main focus is to examine the optimum physicochemical attributes of treated RHA produced precisely.

## METHODOLOGY

### **Ultrafine Treated Rice Husk Ash (UFTRHA) Pre-treatment Process Flow**

Raw rice husk was obtained from local rice factory (BERNAS) located in Sungai Rangan, Perak. Prior to incineration procedure, the rice husk was treated with 0.1N analytical grade (A.G.) hydrochloric acid (HCl). The specimens were soaked and heated at 80°C in the acid solution. After completion of pre-treatment process, the samples were washed using distilled water until its neutral pH obtained and dried using laboratory oven at 110°C. It was then burned by using conventional furnace in laboratory. The burning process was done at 600°C, 700°C and 800°C with 1 hour retention time. The ultrafine treated rice husk ash (UFTRHA) was then ground using planetary ball mill for 15 minutes with ball-to-powder ratio (BPR) of 15:1 and rotation speed at 300rpm.

### **Physicochemical Characteristic of (UFTRHA)**

In this study, chemical composition of UFTRHA prepared at various burning temperatures was examined using X-ray fluorescence (XRF) test. The test was done for UFTRHA sample that undergone pre-treatment in 0.1N HCl solution at 80°C. The analysis was done by using spectrometer of Bruker Axs S4 Pioneer. The test was in compliance with BS EN 12677. As for mineralogical properties determination, X-Ray diffraction (XRD) analysis was done accordingly. This test was conducted using Bruker Axs D8 Advance X-Ray Diffractometer instrument.

Brunnet emmet teller (BET) nitrogen adsorption test was done to examine particle specific surface area of the ground UFTRHA powder. The test was completed with degassing temperature of 300°C using surface area and pore analyser model micromeritics ASAP 2020. Meanwhile, particle size analysis (PSA) was done using Malvern instrument mastersizer, model Scirocco 2000.

### **Pozzolanic / Strength Activity Index**

In order to ensure that the UFTRHA is a reactive pozzolan, it is vital to conduct strength activity index test. Thus, this test was completed in accordance to ASTM C311-98b specifically for ordinary Portland cement (OPC) mortar (ASTM, 2016). The mortars were prepared by blending OPC with the highest SiO<sub>2</sub> content of UFTRHA at 20% replacement level. The strength activity index was calculated as the following equation:

$$\text{Strength Activity Index (SAI)} = (B/A) \times 100$$

\*Where B is the compressive strength value of blended cement at 20% replacement level; A is the compressive strength of control mix

## RESULTS AND DISCUSSION

### Chemical Composition of UFTRHA

Based on the experimental result, it can be observed that the predominant content of rice husk ash is silica ( $\text{SiO}_2$ ). In addition, the  $\text{SiO}_2$  composition in UFTRHA incinerated at  $600^\circ\text{C}$  has highest value among other samples that were prepared at  $700^\circ\text{C}$  and  $800^\circ\text{C}$ . According to the XRF analysis result, the  $\text{SiO}_2$  content in UFTRHA sample produced at  $600^\circ\text{C}$  increased with percentage values of 1.62% and 8.82% as compared to the samples extracted at  $700^\circ\text{C}$  and  $800^\circ\text{C}$  respectively. This finding also indicate that the ideal burning temperature to produce UFTRHA is  $600^\circ\text{C}$ . The chemical composition determination of UFTRHA, X-Ray Fluorescence (XRF) data is summarized in Table 1.

In addition, the amount of alkali metal oxides i.e. sodium oxide ( $\text{Na}_2\text{O}$ ), magnesium oxide ( $\text{MgO}$ ), calcium oxide ( $\text{CaO}$ ) and potassium oxide ( $\text{K}_2\text{O}$ ) contents at all three different burning temperatures were obtained less than 1%. Less in amount of these metallic impurities is vital to enhance the purity of silica extracted from rice husk. By lowering the content of these metallic oxides, especially potassium and sodium, surface melting of  $\text{SiO}_2$  particles can be reduced effectively. The surface melting of  $\text{SiO}_2$  phenomenon will accelerate early crystallization of amorphous  $\text{SiO}_2$  into cristobalite as suggested by several researches in this area (James & Subbarao, 1986; Kalapathy, Proctor, & Shultz, 2001; Krisnarao & Godkhindi, 1992; Real, Alcalá, & Criado, 1996).

**Table 1:** Chemical composition of UFTRHA treated for 4 hours at various burning temperature

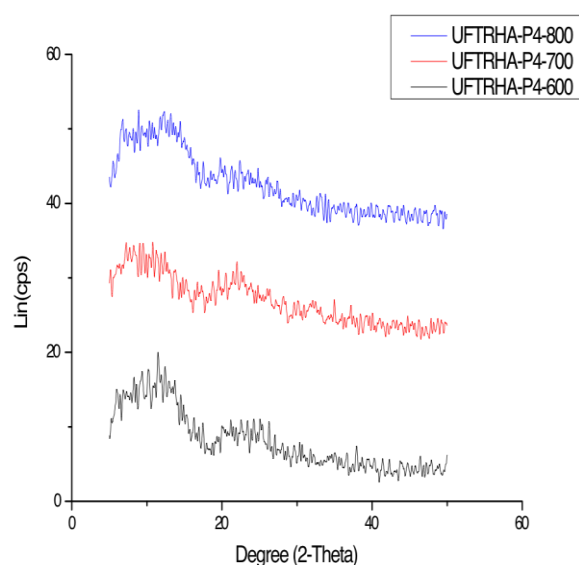
Chemical composition	Chemical content of UFTRHA using 0.1N HCl with soaking duration at 4 hours (%)		
	$600^\circ\text{C}$	$700^\circ\text{C}$	$800^\circ\text{C}$
CC			
$\text{SiO}_2$	98.60	97.00	89.90
$\text{P}_2\text{O}_5$	0.53	1.63	1.48
$\text{Fe}_2\text{O}_3$	0.06	0.25	6.62
$\text{CaO}$	0.36	0.46	0.48
$\text{Al}_2\text{O}_3$	0.13	0.09	-
$\text{K}_2\text{O}$	0.06	0.11	-
$\text{Na}_2\text{O}$	-	-	-
$\text{MgO}$	-	-	0.89
$\text{MnO}$	-	-	0.24
$\text{SO}_3$	-	-	-
Cl	-	-	-
$\text{ZrO}_3$	0.22	0.25	0.12

### Minerological Characteristics of UFTRHA

Amorphousness and crystallinity degree of a material can be determined using the X-Ray diffraction analysis. This analysis was also utilized to determine

mineral presence in the tested material. Figure 1 illustrates the XRD patterns of UFTRHA incinerated at 600°C, 700°C and 800°C respectively.

Based on the XRD analysis, it was noted that all samples of UFTRHA prepared at all temperatures variation i.e. 600°C, 700°C and 800°C were amorphous and without the presence of high intensity peaks. Hence, it is proven that sensitivity towards burning temperature has been eliminated by removing impurities on the surface of the raw rice husk via the pre-treatment process prior to incineration stage. Amorphous state of silica content is vital in order to produce high quality additive material in concrete industry application.



**Figure 1:** XRD patterns of UFTRHA incinerated at 600°C, 700°C and 800°C respectively

### Physical Properties of UFTRHA

Among many of the feasible methods to be used for material size reduction is the mechanical milling process. Hence, this method was adopted in order to reduce size of UFTRHA powder particle. This milling mechanism is attainable using planetary ball mill (Saad, Nuruddin, Shafiq, & Ali, 2016). In this regard, several parameters of the mechanical milling process are to be considered namely milling speed, ball-to-powder ratio (BPR) and duration of grinding.

Table 2 tabulates the particle size analysis of UFTRHA at 4 hours pre-treatment duration and various burning temperature with milling speed, BPR and grinding duration of 300rpm, 15:1 and 15 minutes respectively.

**Table 2:** Particle size analysis of UFTRHA at various burning temperature at 4 hours of soaking time.

Milling Variable	Process	Pre-treatment Soaking (hrs)	Burning Temp. (°C)	Particle Size (µm)		
				d(0.1)	d(0.5)	d(0.9)
BPR: 15:1	speed: 300rpm	4	600°C	1.416	4.364	14.043
Grinding			700°C	1.460	4.676	14.768
Grinding time: 15 mins			800°C	1.205	4.948	21.638

High speed of the grinding process resulted in greater velocity of the ball movements in the milling bowl. Therefore, shearing impact between grinding media (balls) and feed stock (UFTRHA) occurs vigorously in the system hence the smaller particle size obtained (Saad et al., 2016). Based on the data in Table 3, UFTRHA that had been treated for four hours and incinerated at 600°C has finest particle size compared to other UFTRHA samples with d(0.1), d(0.5) and d(0.9) of 1.416µm, 4.364µm and 14.043µm respectively.

On the other hand, Table 3 shows the influence of different burning temperature towards specific surface area (SSA) value of UFTRHA pre-treated using 0.1N HCl for four hours as well. Specific surface area (SSA) value plays an important role in accelerating the pozzolanic reaction of additive materials. Furthermore, large surface area of the pozzolanic material particle also acts as seeds for the generation of denser calcium-silicate-hydrate phase (C-S-H) in enhancing concrete strength development. From the SSA analysis, the highest specific surface area of UFTRHA sample was obtained as 219.58 m<sup>2</sup>/g. This finding is in agreement with the previous experimental analysis where the highest SiO<sub>2</sub> content and finest median particle size were obtained from UFTRHA that was burned at 600°C with four hours of acid pre-treatment procedure. According to data in Table 3, the SSA values reduced as the burning temperature rose up to 800°C.

**Table 3:** Response of Brunnet Emmet Teller – Specific Surface Area (BET-SSA) values to different burning temperatures of UFTRHA pre-treated at 4 hours

BET-SSA Value for Different Sample Type (m <sup>2</sup> /g)	Burning Temperature (°C)		
	600 °C	700 °C	800 °C
UFTRHA (acid pre-treated)	219.58	180.72	133.91

### Pozzolan / Strength Activity Index Analysis

For further examination of pozzolan level of UFTRHA as additive material in concrete, strength activity index (SAI) test was done accordingly. The mix



proportion of SAI test is tabulated in Table 4, where compression values of 50mm<sup>3</sup> cube samples with 20% of UFTRHA replacement were determined at 7 and 28 days respectively.

From the analysis, the SAI values of UFTRHA blended mortar were recorded as 137.17% and 148.21% at 7 and 28 days respectively. These findings give an indication that UFTRHA possesses an excellent pozzolanic / cementing properties, where minimum requirement of strength activity index (SAI) of 75% at both 7 and 28 days as per outlined in ASTM C618-00 (ASTM, 2015).

**Table 4:** Mix proportions for strength activity index (SAI) analysis

Constituent	Control Mix (A)	UFTRHA Blended Mix (B)
OPC (g)	450	360
Sand (g)	1350	1350
UFTRHA(g)	-	90
Water (g)	225	225

## CONCLUSION

The results obtained shows that, the optimum conditions in pre-treatment process play important roles in terms of enhancing the physicochemical properties of UFTRHA. These properties are important in order to produce high quality additive material for concrete technology application. As for the chemical composition analysis, the highest purity of silica content (SiO<sub>2</sub>) is achieved by incineration at 600°C of four hours pre-treated rice husk. On the other hand, the mineralogical assessment concluded that the silica is amorphous as no significant sharp peak presence in XRD analysis at all burning temperatures. The highest amorphous silica content (SiO<sub>2</sub>) of the UFTRHA sample was recorded at 98.60% with particle size median of 4.364µm and specific surface area of 219.58 m<sup>2</sup>/g. Meanwhile, the strength activity index of UFTRHA than that of the control mortar at 7 and 28 days were calculated as 137.17% and 148.21% subsequently.

## ACKNOWLEDGEMENT

The author would like express profound gratitude to the Ministry of Education of Malaysia (MoE) for funding the research work under MyRa Grant Scheme.

## REFERENCES

- ASTM. (2015). *ASTM C618-15 standard specification for coal fly ash and raw or calcined natural pozzolan for use in concrete*. doi.org/10.1520/C0618-15
- ASTM. (2016). *C311/C311m-16 standard test methods for sampling and testing fly ash or natural pozzolans for use*. doi.org/10.1520/C0311-11a.2
- Feng, Q., Yamamichi, H., Shoya, M., & Sugita, S. (2004). Study on the pozzolanic properties of rice husk ash by hydrochloric acid pretreatment. *Cement and Concrete Research*, 34(3), 521-526.
- Food Agriculture Organization [FAO]. (2015). *Rice market monitor April 2015* (Vol. 18).
- James, J., & Subbarao, M. (1986). Characterization of silica in rice husk ash. *American*

*Ceramic Society Bulletin*, 65(8), 1177-1180.

- Juenger, M. C. G., & Siddique, R. (2015). Recent advances in understanding the role of supplementary cementitious materials in concrete. *Cement and Concrete Research*, 78, 71-80.
- Kalapathy, U., Proctor, A., & Shultz, J. (2001). A simple method for production of pure silica from rice hull ash. *Fuel and Energy Abstracts*, 42(1), 45.
- Krisnarao, R. V., & Godkhindi, M. M. (1992). Studies on the Formation of SiC Whikers from Pulverized Rice Husk Ashes. *Ceramics International*, 18, 35-42.
- Mehta, P. K., & Monteiro, P. J. M. (2006). *Concrete: microstructure, properties, and materials*. McGraw-Hill Education.
- Park, C., Salas, A., Chung, C.-W., & Lee, C. J. (2014). Freeze-thaw resistance of concrete using acid-leached rice husk ash. *KSCE Journal of Civil Engineering*, 18(4), 1133-1139.
- Real, C., Alcalá, M. D., & Criado, J. M. (1996). Preparation of silica from rice husks. *Journal of the American Ceramic Society*, 79(8), 2012-2016.
- Saad, S. A., Nuruddin, M. F., Shafiq, N., & Ali, M. (2016). The effect of incineration temperature to the chemical and physical properties of Ultrafine Treated Rice Husk Ash (UFTRHA) as Supplementary Cementing Material (SCM). *Procedia Engineering*, 148, 163-167.
- Salas, A., Delvasto, S., de Gutierrez, R. M., & Lange, D. (2009). Comparison of two processes for treating rice husk ash for use in high performance concrete. *Cement and Concrete Research*, 39(9), 773-778.
- Van, V. T. A., Röbller, C., Bui, D., & Ludwig, H. (2014a). Cement & Concrete Composites Rice husk ash as both pozzolanic admixture and internal curing agent in ultra-high performance concrete. *Cement and Concrete Composites*, 53, 270-278.
- Van, V. T. A., Röbller, C., Bui, D. D., & Ludwig, H. M. (2014b). Pozzolanic reactivity of mesoporous amorphous rice husk ash in portlandite solution. *Construction and Building Materials*, 59, 111-119.
- Van, V. T. A., Röbller, C., Bui, D. D., & Ludwig, H. M. (2013). Mesoporous structure and pozzolanic reactivity of rice husk ash in cementitious system. *Construction and Building Materials*, 43, 208-216.
- Van Tuan, N., Ye, G., Van Breugel, K., & Copuroglu, O. (2011). Hydration and microstructure of ultra high performance concrete incorporating rice husk ash. *Cement and Concrete Research*, 41(11), 1104-1111.
- Van Tuan, N., Ye, G., Van Breugel, K., Fraaij, A. L. A., & Bui, D. D. (2011). The study of using rice husk ash to produce ultra high performance concrete. *Construction and Building Materials*, 25(4), 2030-2035.
- Vayghan, A. G., Khaloo, A. R., & Rajabipour, F. (2013). The effects of a hydrochloric acid pre-treatment on the physicochemical properties and pozzolanic performance of rice husk ash. *Cement and Concrete Composites*, 39, 131-140.



**PLANNING MALAYSIA:**

*Journal of the Malaysian Institute of Planners*

**VOLUME 16 ISSUE 2** (2018), Page 293 - 303

## **INHALABLE AND RESPIRABLE DUST CONCENTRATION OF SOILED STONE, METAL AND CERAMIC ARTEFACT INSIDE NATIONAL MUSEUM MALAYSIA**

**Shamzani Affendy Mohd Din<sup>1</sup>, Nur Baiti Mat Husin<sup>2</sup> & Rashidi Othman<sup>3</sup>**

*<sup>1,2,3</sup>Kulliyyah of Architecture and Environmental Design*  
INTERNATIONAL ISLAMIC UNIVERSITY MALAYSIA

### **Abstract**

Airborne particulate matter is a key indicator of air pollution brought into the air by a variety of natural and human activities. As it can travel in distances and suspended in the atmosphere, it affects human health and museum artefact. The primary idea of this paper is to discuss the mass concentration of airborne particulates matter in terms of inhalable and respirable dust from the stone, metal and ceramic display showcase. The fluctuation of temperature and relative humidity, the museum cleaning activity, the usage of HVAC system and construction activity affect the soiling defect of stone, metal and ceramic artefact. The approach selected to collect primary data for this research is by conducting case study at the National Museum of Malaysia. Personal air sampling was conducted using Casella 7-Holes and Cyclone sampler head. Results revealed high abundances of inhalable dust at stone and ceramic artefact both in Galley A and B. This study is beneficial towards the Jabatan Muzium Malaysia (JMM), Department of Environment (DOE), Ministry of Health (MOH) and Ministry of Natural Resources and Environment (MONRE) by emphasising that reducing air pollution will reduce soiling defect of the museum artefact. Thus, it can reduce government expenses to the museum management towards cleaning procedure for the damaged artefact.

**Keyword:** airborne particulates matter, soiling defects, inhalable dust, respirable dust, artefact

<sup>1</sup>Assistant Professor at International Islamic University Malaysia. Email: shamzani@iiu.edu.my

## **INTRODUCTION**

The conservation of museum artefact is influenced by the indoor environment of the museum such as the museum microclimate and air pollutants. Temperature and relative humidity (RH) variations, metabolic actions and excretions of microorganism and gaseous and particulate pollution all play an important role in the deteriorations of the artefact (Camuffo et al., 2001; Gysels et al., 2004; Hu et al., 2015). So, the temperature, humidity, particulate matter and gaseous buffering determine the microclimate of the museum.

The fluctuation of temperature and relative humidity increases the dust deposition inside the museum gallery and onto the artefact surfaces. As cited by Tzanis et al. (2011) and Hu et al. (2015), the effect of dust deposition towards artefact is called soiling defects or surface blackening. After certain period of time, the deposited dust or airborne particulates will alter the surface of artefact and reduce the cultural and heritage value of the artefact.

Through literature exploration, majority of investigations on the characterization of airborne particulates matter deposited onto the surface of the museum building and museum collections were from United States, Europe, Middle East, and Asian countries such as Japan, China and Malaysia. In Malaysia, there have been similar studies which investigate the heavy metal contained in respirable and inhalable dust in the National Textiles Museum and National Museum of Malaysia.

The researchers have stressed on the scope of heavy metal concentration in the museum showcase, indoor and outdoor. Thus, detail characterization of airborne particulates matter collected from stone, metal and ceramic artefact at three different types of environment such as outdoor, indoor and inside display showcase was analysed. The study is further argued in the differences found in between working day and holiday.

The primary idea of this research is to investigate the existence of heavy metal concentration inside airborne particulates matter which expose the inorganic artefact towards soiling defects. The objectives of conducting this research are (i) to identify the sources of airborne particulates matter affecting the artefact deterioration in the National Museum Malaysia, (ii) to measure the mass concentration of airborne particulates matter in the National Museum Malaysia, (iii) to analyse the contents and composition of heavy metal from the airborne particulates matter in the National Museum Malaysia and (iv) finally to propose the methods of reducing artefact deterioration in the museum.

This paper will only discuss on the matter pertaining to the mass concentration of airborne particulates matter in terms of inhalable and respirable dust from the stone, metal and ceramic display showcase.

## **LITERATURE REVIEW**

Airborne particulates matter suspended in the atmosphere are known as dust, dirt, soot, smoke and liquid droplets. Museum artefact that are exposed to airborne particulates matter come from various indoor sources. The sources includes the use of HVAC system (Camuffo et al., 2001; Fu & Li, 2006), cleaning services (Afshari, Matson, & Ekberg, 2005; Guo et al., 2010), vacuuming process (Afshari et al., 2005), particulates from displayed artefact or storage room (Abdel-Kareem, 2010; Nazaroff, 2002), open entrance (Blondeau, Iordache, Poupard, Genin, & Allard, 2005; Anaf et al., 2012), particulates from outside and from visitors (Horemans, Schalm, De Wael, Cardell, & Grieken, 2012; Hu et al., 2011) and occupants in the museums (Hospodsky et al., 2012; Saraga, Pateraki, Papadopoulos, Vasilakos, & Maggos, 2011).

From all the sources mentioned above, the airborne particulates matter will be suspended inside the museum gallery and deposited onto the artefact either vertically or horizontally due to gravitational forces. The airborne will be deposited on the display boxes, display textile frames, gallery floors, painting, sculpture and exposed artefact. After some time, the soiling defects can be seen clearly, for instance through blackening of the surface or brownish spots on paper. Therefore it is supported that airborne particulates matter significantly affects the soiling of the artefact.

Airborne particulates matter in the atmosphere significantly affects global climate (Fisk, 2015), human health (Adar, Filigrana, Clements, & Peel, 2014; Kim, Kabir, & Kabir, 2015), flora and fauna as well as building materials (Watt, Jarett, & Hamilton, 2008 & Tzanis et al., 2011). The airborne particulates matter in the air is distributing in all types of ecosystems from desert to oceans by cooling and heating the atmosphere. Large cities with higher traffic and poor air pollutant dispersion are more susceptible to negative health effects due to airborne particulates matter.

Moreover, high traffic density in urban areas has higher PM<sub>2.5</sub> levels compared to the suburban background area. Hence, transportation sector in big cities plays important roles in the distribution of pollutants to the atmosphere. Due to the heavy traffic density and rapid urban development, global warming and climate change occur.

Airborne particulates originate from various manmade and natural sources such as car exhaust, power plants, forest fires, evaporation from petroleum products, agriculture, natural living plants, dust storms, breaking ocean waves, volcanoes (NASA Ames Research Center, 2007). The airborne particulates in terms of haze particles suspended in the atmosphere, affect the climate by changing the flow of radiant energy from the sun to the Earth's surfaces and within the atmosphere. Airborne particulates directly, scatter and absorb solar radiation while indirectly changing cloud properties, rain, snow, and atmospheric mixing.

The outdoor pollutants will enter the building through various sources such as street dust, motor vehicle exhaust, and buildings heating facilities or human activity. Then, the airborne particulates matter will disperse and deposit into the building to become dust. As explained by Yoon and Brimblecombe (2001), the deposited dust can detract and soils museum artefact, furniture and fittings appearance. Furthermore, dust that deposits inside the building can transport harmful chemical substances to the surface of museum collections.

## **METHODOLOGY**

The sampling location for the research is National Museum Malaysia. The museum is chosen because it is located in the city centre of Kuala Lumpur and 50 meters from the museum south entrance have an ongoing construction of Mass Rapid Transport (MRT) and also Jalan Damansara. Besides, 100 meters from the museum north entrance is facing the congested highway named Jalan Damansara. Hence, it is proven that the museum is critically exposed towards transportation and construction particles pollutants.

This research studies the soiling defect of inorganic artefact which includes stone, metal and ceramic. Based on previous research, dust deposition or soiling defect on inorganic artefact are more visible and crucial compared to organic artefact. Gallery A and Gallery B of National Museum Malaysia are likely to have most of the 3 types of inorganic artefact. The location and name of each artefact inside the National Museum Malaysia can be referred in Table 1.

After determining the case study, personal sampling method was conducted. In order to represent the inhalable and respirable dust, Casella 7-Holes and Cyclone sampler head were used to measure the individual personal exposure towards airborne particulates. The sampling was conducted for 8 hours during museum office hour which is from 9 a.m. to 6 p.m. The research collected an overall sixty-four (64) samples. There were sixteen (16) sampling points during weekdays and weekends respectively. Thirty-two (32) samples alone were collected for 7-Holes sampler head along with thirty-two samples (32) from Cyclone sampler head.

Samples were then transported to the Herbarium laboratory to digest the metals from the airborne particulates using Milestone S.r.l. - START D - Microwave Digestion System. Next, samples were replicated into three (3) sections to conduct elemental analysis through Perkin Elmer NexION 300X ICP-MS. Finally, the results were run through statistical analysis using Statistical Analysis System (SAS) software. The analysis involved two-way analysis of variance (ANOVA) test. The analysis was done to observe the metal interaction with different museum location, time of exposure, type of sampling head and metal concentration.

**Table 1:** The location of the soiled stone, metal and ceramic artefact inside Gallery A and B of the National Museum Malaysia.

	GALLERY A	GALLERY B
STONE ARTEFACT	 Stone artefact discovered in the Bujang Valley	 Foundation stone discovered in the Bujang Valley
METAL ARTEFACT	 Bronze drum and bell originated from Vietnam	 Silver boxes belonged to the Malay royal family
CERAMIC ARTEFACT	 Pottery appliances from Sarawak, Sabah, Pahang and Kelantan	 Ceramics as trade goods showing Islamic influence entered Melaka from China

*Source: National Museum Malaysia, 2017*

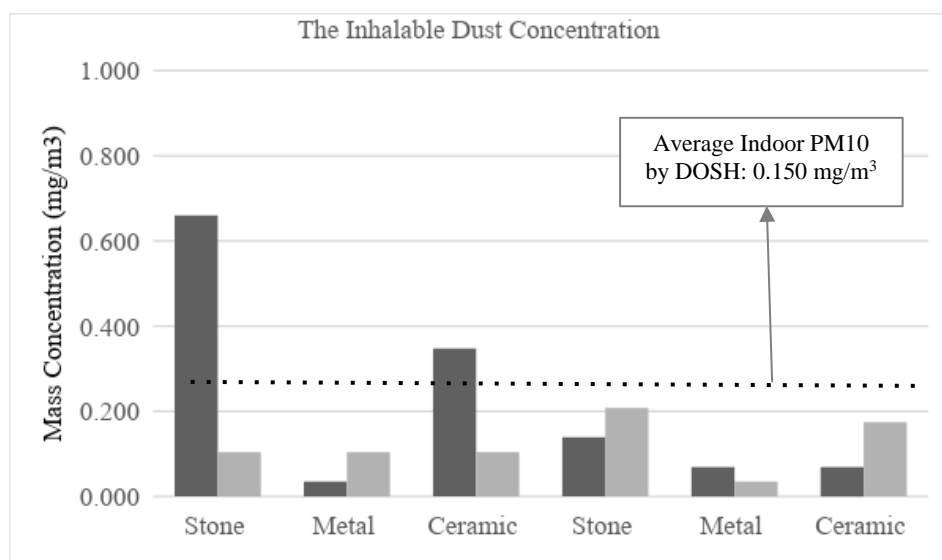
### ANALYSIS AND DISCUSSION

This section discusses the analysis of inhalable and respirable dust concentration in the comparison between weekday and weekend sampling at Gallery A and Gallery B of the National Museum Malaysia. The discussion emphasize on the comparison of the relationship between inhalable and respirable dust concentration. Table 2 below shows the results for mass concentration of inhalable and respirable dust collected from stone, metal and ceramic artefact in comparison to the weekday and weekend sampling exposure. The bar graphs in Figure 1 and Figure 2 are rendered for further discussion regarding the comparison between the two galleries.

**Table 2:** The mass concentration of inhalable and respirable dust collected from stone, metal and ceramic artefact

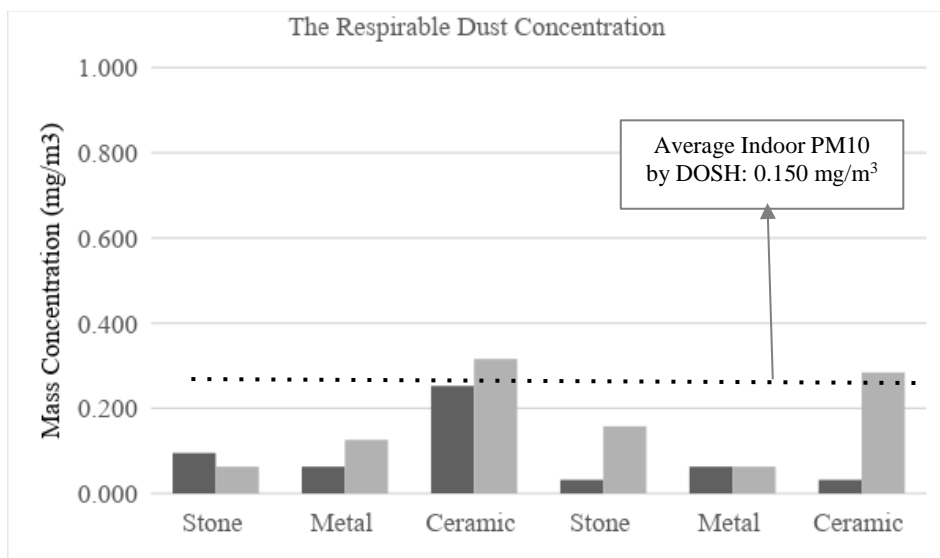
Type of Gallery	Type of Artefact	Inhalable Dust		Respirable Dust	
		Weekday	Weekend	Weekday	Weekend
Gallery A	Stone	0.660	0.104	0.095	0.063
	Metal	0.035	0.104	0.063	0.126
	Ceramic	0.347	0.104	0.253	0.316
Gallery B	Stone	0.139	0.208	0.032	0.158
	Metal	0.069	0.035	0.063	0.063
	Ceramic	0.069	0.174	0.032	0.284

Figure 1 below shows that the weekday mass concentration of Gallery A stone (0.660mg/m<sup>3</sup>) and ceramic artefact (0.347 mg/m<sup>3</sup>) display showcases was the highest when compared with the other 6 artefact in Gallery A and Gallery B. However, their mass concentration in the weekend was not exceeding the average DOSH standard. In comparison with the artefact from Gallery B, the mass concentration from weekends sampling is considerably high at both stone and ceramic display showcases with the value of 0.208 mg/m<sup>3</sup> and 0.174 mg/m<sup>3</sup> consecutively.



**Figure 1:** Comparison of inhalable dust concentration between weekday and weekend sampling from display showcase in Gallery A and B.





**Figure 2:** Comparison of respirable dust concentration between weekday and weekend sampling from display showcase in Gallery A and B.

From the above results, the weekday dust concentrations at the stone and ceramic artefact are the highest due to the location of the display showcase. The stone display showcase at Gallery A was located 18 meters near to the gallery entrance while at Gallery B, 15 meters away from the gallery entrance. Hence, particles pollution from outdoor sources that suspended in air enter Gallery A and B and deposited more at stone and ceramic artefact.

Besides, Gallery A and Gallery B were situated on the ground floor as well as attached to the museum lobby where many tourists gather hence there would be a lot of air exchange (Hu et al., 2011). In addition, the number of tourists coming into the museum during the weekday are more than the weekend. Moreover, the north entrance of the museum was facing the MRT construction and Jalan Damansara. The particle pollutants from construction and transportation penetrated into the museum lobby through doors and windows gap (Angell, 2005; Charlesworth, Everett, McCarthy, Ordóñez, & de Miguel 2003).

Furthermore, the high concentration of airborne at stone and ceramic artefact was due to the various indoor sources. The significant source was the existent particulates released from the archaeological artefact itself (Grossi, Esbert, Diaz-Pache, & Alonso, 2003). Besides, the cleaning activities which was done every morning used chemical solution which affected the dust deposition in the display showcase (Guo et al., 2010).

From the graph in Figure 1 and 2, it was clear that airborne particulates collected in metal artefact display showcase from Gallery A and B had the lowest concentration. The display showcase was 43 meters far away from the gallery

entrance. So, fewer particles were deposited inside the display showcase. The findings showed that metal artefact exhibited in Gallery A and Gallery B were not prone to dust deposition. Metal artefact had more tendencies to corrosion (Schiavon, Celauro, Manso, Brunetti, & Susanna, 2013; Tzanis et al., 2011). As can be seen from the stone and ceramic artefact in Figure 3 and 4 below, soiling defects were more visible at the stone and ceramic artefact in the Gallery A and Gallery B.



**Figure 3:** Stone artefact discovered in the Bujang Valley

*Source: National Museum Malaysia, 2017*



**Figure 4:** Pottery appliances from Kelantan

*Source: National Museum Malaysia, 2017*

When comparing the overall dust concentration between total inhalable dust and respirable dust as in Figure 1 and 2 above, the analysis indicated that the fraction of airborne particulates entered the nose and mouth and deposited into the respiratory tract of museum visitors was significantly higher than the fraction of airborne particulates that penetrated into the human lung. Particles that deposited either in the respiratory tract or in the lung and remained for a long time increased the potential of diseases to the museum visitors.

Such diseases could be heart or lung disease, nonfatal heart attacks, irregular heartbeat, aggravated asthma, decreased lung function, and increased respiratory symptoms such as irritation of the airways, coughing, or difficulty breathing (Kim et al., 2015). As described by Shamzani Affendy and Pooley (2016), the size of respirable dust is defined by their ability to gain access to the human lung. Thus, the dust exposure will bring harm towards the health of museum visitors and the artefact, even though the concentration of respirable dust is found lower than inhalable dust. Dust deposition at stone and ceramic artefact will cause an irreversible damage and loss of culture and social value.

## CONCLUSION

In conclusion, the objective of research which is to determine the mass concentration of airborne particulates soiling defect is achieved. The mass concentration of total inhalable dust at Gallery A and Gallery B were significantly higher than respirable dust. The exposure of airborne particulates was seen critically at stone and ceramic artefact due to both outdoor and indoor sources. However, metal artefact was less affected to soiling defect because the material is prone towards corrosion. The high concentration of inhalable dust and respirable dust cause harm towards artefact in terms of soiling as well as harmful to the museum visitors' health.

The results from this study stressed the importance of controlling and reducing outdoor and indoor pollution in relation to artefact conservation and preservation by the specialist and management of the Jabatan Muzium Malaysia (JMM). This study is beneficial to the Department of Environment (DOE), Ministry of Health (MOH) and Ministry of Natural Resources and Environment (MONRE) through emphasizing that reducing air pollution will reduce soiling rates of museum artefact. Thus, it can reduce government expenses on cleaning procedure of the damaged artefact. If soiling can be prevented, future generation can also gain benefit in learning about the historical heritage of Malaysia.

## ACKNOWLEDGEMENT

The authors would like to acknowledge the Ministry of Higher Education (MOHE) for providing grant RIGS16-394-0558 and IIUM Research Management Centre for facility support to make this research possible.

## REFERENCES

- Abdel-Kareem, O. (2010). Monitoring, controlling and prevention of the fungal deterioration of textile artifacts in the museum of Jordanian heritage. *Mediterranean Archaeology and Archaeometry*, 10(2), 85-96.
- Adar, S. D., Filigrana, P. A., Clements, N., & Peel, J. L. (2014). Ambient coarse particulate matter and human health: A systematic review and meta-analysis. *Current Environmental Health Reports*, 1(3), 258-274.
- Afshari, A., Matson, U., & Ekberg, L. E. (2005). Characterization of indoor sources of fine and ultrafine particles: a study conducted in a full-scale chamber. *Indoor Air*, 15(2), 141-50.
- Anaf, W., Horemans, B., Madeira, T. I., Carvalho, M. L., Wael, K. De, & Grieken, R. Van. (2012). Effects of a constructional intervention on airborne and deposited particulate matter in the Portuguese National Tile Museum, Lisbon. *Environmental Science and Pollution Research*, 20(3), 1849-1857.
- Angell, W. (2005). Construction and indoor airborne contaminants. *InformeDesign*, 3(7),

1-4.

- Blondeau, P., Iordache, V., Poupard, O., Genin, D., & Allard, F. (2005). Relationship between outdoor and indoor air quality in eight French schools. *Indoor Air*, 15(1), 2-12.
- Camuffo, D., Van Grieken, R., Busse, H.-J., Sturaro, G., Valentino, A., Bernardi, A., ... & Ulrych, U. (2001). Environmental monitoring in four European museums. *Atmospheric Environment*, 35(1), 127-140.
- Charlesworth, S., Everett, M., McCarthy, R., Ordóñez, A., & de Miguel, E. (2003). A comparative study of heavy metal concentration and distribution in deposited street dusts in a large and a small urban area: Birmingham and Coventry, West Midlands, UK. *Environment International*, 29(5), 563-573.
- Fisk, W. J. (2015). Review of Some Effects of Climate Change on Indoor Environmental Quality and Health and Associated No-Regrets Mitigation Measures. *Building and Environment*, 86, 70-80.
- Fu, Z., & Li, N. (2006). Airborne particulate matter in HVAC systems and its influence on indoor air quality. *Energy Systems Laboratory, Texas A&M University*. Retrieved from <http://hdl.handle.net/1969.1/5270>
- Grossi, C. M., Esbert, R. M., Diaz-Pache, F., & Alonso, F. J. (2003). Soiling of building stones in urban environments. *Building and Environment*, 38(1), 147-159.
- Guo, H., Morawska, L., He, C., Zhang, Y. L., Ayoko, G., & Cao, M. (2010). Characterization of particle number concentrations and PM<sub>2.5</sub> in a school: Influence of outdoor air pollution on indoor air. *Environmental Science and Pollution Research International*, 17(6), 1268-1278.
- Gysels, K., Delalieux, F., Deutsch, F., Van Grieken, R., Camuffo, D., Bernardi, A., ... & Wieser, M. (2004). Indoor environment and conservation in the Royal Museum of Fine Arts, Antwerp, Belgium. *Journal of Cultural Heritage*, 5(2), 221-230.
- Horemans, B., Schalm, O., De Wael, K., Cardell, C., & Grieken, R. Van. (2012). Atmospheric composition and micro-climate in the Alhambra monument, Granada (Spain), in the context of preventive conservation. *IOP Conference Series: Materials Science and Engineering*, 37, 12002.
- Hospodsky, D., Qian, J., Nazaroff, W. W., Yamamoto, N., Bibby, K., Rismani-Yazdi, H., & Peccia, J. (2012). Human occupancy as a source of indoor airborne bacteria. *PLoS One*, 7(4), e34867.
- Hu, T., Cao, J., Ho, K., An, Z., Lee, S., Chow, J. C., ... & Li, H. (2011). Winter and summer characteristics of airborne particles inside Emperor Qin's Terra-Cotta Museum, China: A study by scanning electron microscopy-energy dispersive x-ray spectrometry. *Journal of the Air & Waste Management Association*, 61(9), 914-922.
- Hu, T., Jia, W., Cao, J., Huang, R., Li, H., Liu, S., ... & Zhu, Y. (2015). Indoor air quality at five site museums of Yangtze River civilization. *Atmospheric Environment*,

123(Part B), 449-454.

- Kim, K., Kabir, E., & Kabir, S. (2015). A review on the human health impact of airborne particulate matter. *Environment International*, 74, 136-143.
- NASA Ames Research Center. (2007). *NASA studies how airborne particles affect climate change*. Retrieved July 24, 2017, from [www.sciencedaily.com](http://www.sciencedaily.com)
- Nazaroff, W. (2002). Indoor particulate matter of outdoor origin: Importance of size-dependent removal mechanisms. *Environmental Science and Technology*, 36(2), 200-207.
- Saraga, D., Pateraki, S., Papadopoulos, A., Vasilakos, C., & Maggos, T. (2011). Studying the indoor air quality in three non-residential environments of different use: A museum, a printery industry and an office. *Building and Environment*, 46(11), 2333-2341.
- Schiavon, N., Celauro, A., Manso, M., Brunetti, A., & Susanna, F. (2013). Iron-Age bronze statuettes in Southern Portugal: Combining archaeological data with EDXRF and BSEM + EDS to assess provenance and production technology. *Applied Physics A: Materials Science and Processing*, 113(4), 865-875.
- Shamzani Affendy, M. D., & Pooley, F. D. (2016, August). Comparison of the physical characteristics of airborne and inhaled coal dust samples. *Environmental Conservation, Clean Water, Air & Soil (CleanWAS)*. August 26-28, 2016, China.
- Tzanis, C., Varotsos, C., Christodoulakis, J., Tidblad, J., Ferm, M., Ionescu, a., ...& Kreislova, K. (2011). On the corrosion and soiling effects on materials by air pollution in Athens, Greece. *Atmospheric Chemistry and Physics*, 11(23), 12039-12048.
- Watt, J., Jarrett, D., & Hamilton, R. (2008). Dose – response functions for the soiling of heritage materials due to air pollution exposure. *Science of the Total Environment*, 400(1–3), 415–424.
- Yoon, Y. H., & Brimblecombe, P. (2001). The distribution of soiling by coarse particulate matter in the museum environment. *Indoor Air*, 11(4), 232-240.



**PLANNING MALAYSIA:**

*Journal of the Malaysian Institute of Planners*

**VOLUME 16 ISSUE 2 (2018), Page 304 - 322**

## **CLASSIFICATIONS OF CLASSICAL MALAY ARISTOCRATIC ARCHITECTURE: IDENTIFYING GENERIC AND VARIANT FORMS**

**Tengku Anis Qariah Raja Abdul Kadir<sup>1</sup>, Puteri Shireen Jahn Kassim<sup>2</sup>,  
Noor Hanita Abdul Majid<sup>3</sup>, & Zumahiran Kamaruddin<sup>4</sup>**

<sup>1,2,3,4</sup>*Kulliyah of Architecture and Environmental Design*  
INTERNATIONAL ISLAMIC UNIVERSITY MALAYSIA

### **Abstract**

The paper reports on a basic classification based on formal and morphological similarities of large vernacular buildings across the Malay region, based on their frontages; with the aim of developing a universal regional language and set of rules of local architecture for urban and multi-storeys typologies. Generally, seen as idiosyncratic and individualistic, Malay regional palaces and mansions across different states and regions under former Sultanates, exhibit different vocabularies, yet have underlying similarities. While form and architecture may arise from the local technology and construction methods of the era, aesthetic expressions of these palaces recall formal archetypes which can be described, and characterised, regardless of location. Focusing on palaces in Malaysia and East Sumatran region from the late 1800s onwards, recurring forms of a Malay-Classical language are observed and classified into generic morphologies of frontages. The aim is towards formal taxonomy that can represent a more inclusive architectural identity of the region, rather than identities based on nations. By defining the ‘generic’ and the ‘variant’, significant palaces across the Malay region are discussed and positioned within a classification based on a range of generic archetypes. Variants include cases which have absorbed external influences yet retain the essences of local form, while some examples, refer to elements that have modernised been yet represent the last offshoot or branch of the same region. To identify generic rules and frameworks of design, the regional roots of form, including frontages, for public buildings is crucial for urbanscape and the urgency of developing guidelines and a set of compositional rules and language of urban architecture derived from the essences of tradition and past forms.

**Keywords:** classical rules, regionalism, Malay identity, aristocratic form

<sup>1</sup>PhD candidate at International Islamic University Malaysia. Email: tengkuanis.iium@gmail.com

## INTRODUCTION

The idea of the 'Classical' is generally related to a set of elements which are imported from the West or related to European traditions. Yet Porphyrrios (1989) defines 'Classicality' in architecture as not a 'style' but an ageless principle; or a grouping of similarities and common forms. He states: *'On the contrary, what makes Classical architecture possible is the dialogic relationship it establishes between the craft of building and the art of architecture. Our imagination traverses this dialogic space between, a pergola and a colonnade and establishes hierarchies, levels of propriety and communicable systems of evaluation. The classical architecture also needs another dialogic relationship: this time the relationship between one building and another.'*

Classicality, as an architectural language, though having Greek origins, began to be promulgated and practised as a 'treatise' or 'set of common principles' for design of public buildings in the time of the Renaissance. Evers, Biermann, and Thoenes (2003) highlight, *'...Bearing this in mind, it is no coincidence that the first three major treatises on the architecture of the early Renaissance period arose at the courts of Italy'*. Both Evers et al. (2003) and Rae (2017) recall the origins of Classicality as a principle in the royal realm of the Italian courts, where both the 'nobility' and the 'bourgeois' played a role in defining monumental architecture in the public realm. Malay architectural traditions have their public realm in the 'monumental' expressions of their palaces, yet presently, many have linked the Malay design language to a set of expressions and elements of vernacular form. This must have limited its potential as a public language, as the 'vernacular' has historically evolved into, and linked to the movement of the 'picturesque', while classical architecture is what gave public buildings the rule of 'controlled design' and a 'rationally'-grounded set of rules for the government large, public buildings.

Throughout the Malay-Nusantara regions, palaces have been the center of Sultanate polities, and reflect a range of functions and types, yet essentially the larger or main types play a dual role; a residential and administrative one. These larger, more complex types typically have frontages and in traditional times, are generally open to the public, with open spaces that essentially represent the 'public realm' or what the renowned philosopher Hannah Arendt, calls 'the space of public appearance'. In order to respond to the need for local identity in cities and in public buildings, these traditional roots needed to be studied and mapped. Yet the South-East Asian region represents one of the most culturally diverse regions in the world. 'Aristocratic' architecture refers to a range of types and language, and forms, which arise from aristocratic groups or persons, and which have both private and public zones, shared by the community or polity. Due to their symbolic position, these have absorbed neighboring or external influences over centuries. Palaces include those which are conventionally referred to as mansions and houses of community leaders. These reflect some of

the highest forms of artisanal skills of the locale and a confluence of aesthetic identity in the region. Example of aristocratic architecture which are not royal palaces are, the Panglima Ghani House, Melaka and Dato Bji Sura House, Kota Duyong, Terengganu which reflect Malay form and identity; yet demonstrate the hybridity of cultures as they demonstrate syncretic or multicultural elements.

### **THE “VERNACULAR” AND THE “CLASSICAL”**

While vernacular houses refer to what is known as 'architecture without architects' and generally encompass the multitude of residential buildings which reflect the age-old traditions of local artisanship, the localities prevailing materials, and enduring character of place, the 'Classical' is often linked' to the 'symbolic', or the 'representational' or simply, 'self-conscious' buildings. Palaces have frontages which are designed 'conscious' of its role in the public realm and hence are conceptualised as a whole; and often reflect a degree of classicality. 'Classicality', as a set of norms and key rules of an aesthetic style, has thus often been linked to frontages that express symmetry, ceremoniality and infuse with a degree of symbolism. Hence in the ancient past, these are buildings which were designed with a distinctive 'facade'. Classicality is related to what is 'enduring' and 'timeless' (Summerson, 1980). He states: 'A classical building is one whose decorative elements are derived directly or indirectly from the architectural vocabulary of the ancient world'. A 'classical language' is a 'composition of elements', which 'together... shows the relationship of all parts.... the classical architect sought for symmetry and harmony. Symmetry and balance can be summarised as the principle of composing a series of combined elements in a simple yet visual approach, and these are reflected the 'public' face of Malay vernacular palaces; which are an outcome of the higher resources, capabilities and wealth of the Malay courts.

South East Asia in the 1800s, was a region suddenly infused with dynamic economic energies (Gullick, 1987). The 'public' buildings of these region, whether they are from the ruling elites or community leaders, became infused with new technology and often renovated with additional and stylised masonry elements. There was a degree of modernisation, which was the result of a natural evolution of progress, and the need to appear 'modern', and these stylisations were not necessarily 'Colonial' design or the result of conscious copying of imported styles. Across the region, palaces became the site of a dynamic tension, between the identity of the Sultanate-based polity and the pressure of external powers to the region. Yet until early 1900s, these had consistently reflect local culture, rather than imported styles. It is important that shared characteristics are identified, and in this study, is defined as what is 'Generic' including any characteristic underlying overall form of, or relating to a class or group of things or objects. Hence the term 'generic' can be used to organise a taxonomy, which is crucial in order to create new terminologies, or an



organised database for information retrieval. 'Variants' is generally known as forms manifesting variety, deviation or disagreement, which deviate slightly from the standard form, can then refer to the specific variation between the subregion or subcultures. Hourigan (2015) has observed a continuing difficulty of classifying the vernacular forms, due to its wide and diverse range of expressions. Hence to derive principles, the search for a framework of classification of palaces must begin with the 'generic'. Wong (1995) suggest such generic forms from observing how these palaces are mainly reflections of the Malay vernacular 'archetypal' houses, which evolve and become 'enlarged' to public buildings which are essentially state-based styles (Nasir & Wan Teh, 1997).

### **METHODOLOGY**

Based on measured drawings, and a collection of palatial photos, historical documentations including drawings of individual case studies (Mohamad Rasdi, Mohd. Ali, Syed Ariffin, Mursib, & Mohamad, 2005), the study attempts to define overall form and observed elements and language that can constitute generic forms, while variants are derivations from the consistency of such generic forms and their vocabulary. Abd Rashid and Che Amat (2014) usefully divides the Malay language into 'structure', and 'ornamentation'; while Shuaib (2013) had usefully outlined; in his description of the essentials of the Kelantan style, by dividing into specific elements of overall architecture, construction and ornamentation. Jahn Kassim, Nawawi and Abdul Majid (2017) charted the evolution of architectural works and buildings in South East Asia, to extend the Malay language and identity making in architecture to include recent modern urbanscape and 'critical' attempts to express regionalism in a range of modern typologies. Yet in terms of region, one must differentiate between the boundaries of the 'nation' and the 'region' as ethnicity is often harnessed for a specific national agenda, rather than refer to a historical regional phenomena. The broader geographical boundaries of the Malay world have been discussed by many (Milner, 2011, Andaya, 2010), but to develop the region's aesthetic rules, one must also delve into its origins. Ibrahim (2017) states, '*...The (Malay) royal palaces recall a sense of ideal form. Derived from a timber-based construction tradition, the typology was developed through a rich layering of spatial and aesthetic treatments. The range of expression and variations of treatments and proportions are adapted into systems of walls, windows and openings. These palaces demonstrate the Malay grammar which reflects the rich traditions of the Malay world.*'

A relook at aristocratic forms including palaces is thus necessary to search and define the shared characteristics of a region. The attempt is to uncover underlying principles and rules in an attempt to link a diverse region and go beyond the idiosyncratic and parochial; and into the 'universal'. The significance of focusing on the Classical is to represent an alternative to the 'vernacular' and

to elevate and allow rules to be defined for modern buildings and thus critically relate past forms to the rising urbanisation of cities. The research also uncovers a shared vocabulary derived from its shared roots, including its origins from timber forms and construction. Watkin (2011) interestingly highlights how Classical architectural rules in the West had begun in the same way, i.e. through the 'transmutation' or the 'petrification' of timber elements, for example, the Greek pediment was initially related to the gable roof of the local timber buildings of its ancient past. The aim is towards a theory which transcends the moment and reveals an architectural idea. The desired result is the development of set of rules that could be used to generate ideas. The aim is delineate archetypal forms to recall patterns towards formative ideas from a diverse resource and language, which further language might evolve. It can be observed that certain patterns persist through time, regardless of the relationship to place.

#### **CASE STUDIES AND FOCUSING ON A REGION**

Milner (2011) and different researchers have defined the Malay world and its geographical boundaries as generally encompassing amongst others, Indonesia, Malaysia, Borneo, South Philippines, South Cambodia and South Thailand. Though there are slight differences in the definition, what is agreed and commonly found is that the origin of the Malay region can be traced to an area in South Sumatera around the Jambi/Palembang region (Milner, 2011; Andaya, 2010). Andaya (2010) for example, referred to the Malay world lands as the 'Sea of Malayu'. As he usefully observes: '*For the Malayu, who were shaped by their orientation to the sea and to the riverine environment in which they lived, stretches of land were viewed as barriers that fortunately could be breached by short land passages*'. Reid (2004) defines the Malay region as Kerajaan Melayu ('Malay kingdoms'), as those lands ruled by Malay Sultanares and refers to various lands and regions encompassing Brunei, Indonesia, Malaysia, Singapore, Southern Thailand, Sumatra, Borneo and is sometimes used interchangeably with the concepts of 'The Malay Archipelago' and 'Nusantara'.

The following case studies include the palaces and aristocratic buildings in East coast of Malaysia, Brunei, Indonesia, Singapore, Southern Thailand and Sumatra. Each case study is studied in terms of frontages and spatial form and through time, distinctive aesthetic additions and stylizations of ornamentations are noted. What is consistently seen is how these building demonstrate a Classicality, yet tinged with a refined use of complex decorative motifs derived from the local flora, and which can be said as the hallmark of the 'high' aristocratic styles. The forms and treatments are the outcome of the resources of the local monarch/aristocrat and the highest groups of artisans, or individual craftsmen. Decorative elements are often expressed at the 'edges' of elements of such palatial forms, i.e. such as adorning the eaves, fascia boards, and doors. These finials, function like decorative 'lace' adorning a dress or clothes of a person. In

architecture, these decorative motifs draw attention to the upper 'class' aesthetic identity of the building and on closer look, the Malay world is distinctive for the inspired patterns in architecture, extracted from the surrounding flora and fauna, instantly reflecting the closeness between the locality and the artisans.



**Figure 1:** The reaches of the 'Malay region' and the locations of pre-colonial Sultanates

Source: Milner, 2011

Spatially, the palace reflect the 'tropical archetype', and is typically a large house with an enhanced portico, and the typology is generally imbued with a ceremonial character, particularly in the frontages of the structures. Palaces and aristocratic structures were during these times, the 'theatrical' version of the 'vernacular'. Their 'classical' features are often representing the ethos and personality including the ingenuity of the monarch himself who often acts as the designer or concept maker of the building style and expression. While it can be argued that palatial forms often reflected the whims, idiosyncrasies and predispositions of individual monarchs, yet on closer inspection, the study suggests that there are shared characteristics of a 'Classical' Malay identity which have evolved. These forms were later recognized as complexes that reflected the apotheosis of the Malay vernacular. They demonstrate different parts of a continuum of styles from Sultanate to Sultanate, yet there are overlapping patterns due to the hybridization of 'civilizations' across time and place. These

have been linked to dynamically changing ‘galactic’ polities (Andaya, 2010) and manifest also in a range of expressions of hybrid cultures. Palaces also reflect a form of localized ‘Classicality’, which reflect the Malay social structure, in space but elevationally, is imbued with local craftsmanship and local motifs. The palace form is a reflection of an essential Malay feudal organization, with similar private and semi-public spatial domains. The complexity of domains varies, and variants can be traced to a root, and the traditional houses reflect a condensed version of the larger palaces, while portraying the same spatial divisions. In palaces, these are amplified in a hierarchical sense. Both horizontal and vertical façade morphologies mirrors the social structure of the feudal Malay world.

The regions of Malaysia and Eastern Sumatera which borders the Straits of Malacca occupy a central position in the regional origin of the ‘Melayu’ before and after the fall of the Malacca Empire. Historically the Malay states on both sides of the Straits of Malacca lie on opposing sides of a dynamic region bordering and facing an active waterway. These have had active political, economic and cultural exchanges in the past centuries. The Anglo-Dutch Treaty of 1824 had massive repercussions in the region, and which had culturally, and geographically divided what was a homogenous cultural region into two blocks of cultural domains. The Dutch had secured British settlements such as Bengkulu and Sumatera, in exchange for ceding control of their lands in the Malay Peninsula and Dutch India. The common region and universality of the Malay – Sumatera culture and civilization was once connected universally and considered as one region and the historical circumstances became a series of nations. Andaya (2010) highlights how the unique geographic region was then separated by an event in history, ‘...*The 1824 agreement represents a turning point in the shaping of modern Malaysia, for the division of the Malay would down the Melaka Straits laid the basis for the contemporary boundary with Indonesia. Setting aside centuries of history without a qualm, the Riau-Johor kingdom was irrevocably divided, and the cultural unity of east coast Sumatra and the Peninsula arbitrarily severed.*’

During the nineteenth century, palaces reflect the traditional socio-political systems of the Malay civilizations and were manifested in forms that reflects spaces underlying the core cultural institutions that played both spiritual and cultural role in the region. Amoroso (2002) further describes, ‘...*Malay politics before colonial rule was control of workforce embedded in a spiritual system of leadership*’ and ‘their success was measured by graceful demeanour and the spiritual rewards they bestowed as much as by their military achievements’. Gullick (1987) similarly observes the central position of the Malay rulers in defining the core of the Malay culture and practices of these rulers was due to, ‘...*the justification for giving so much prominence to them is that they play a leading part in their communities. By their office, they were men of influence, whose precept and example had a widespread effect, especially in the*

*upper class of Malay society, which came into close contact with them and related their status to ties of kingship with the royal dynasty, or the holding of court office. The rulers were also more exposed than most of their subject to external influences...'*

In the case studies mentioned, and during this era, physical alterations were done by the ruling monarchs, but often these were always principle alterations. Changes were made but within the archetypical form and aspects of language of the locality that were sustained. Nasir and Wan Teh (1997) observe, '...The beautiful carvings produced at the palace are associated with the status symbol of an administration and indirectly had accorded recognition to the art of traditional Malay woodcarving'. In the words of Andaya (2010, p:80), 'A simple arrangement prevailed in the Malay areas, with a Malay kingdom consisting of a sultan with many of his residing close to the royal residence, and other family networks headed by powerful officials or chiefs with their constituencies.' Malay subjects considered themselves not in states or governments but in a 'Kerajaan' which can be defined as a system or 'the condition of having a raja'. As Milner (2011) describes, '...The Malay rulers reflected the organizing principle in the Malay world'. As custodians of its culture, the Malay Sultans and the aristocracy is at the core of its society. The rulers were judged or assessed by relating his action on how the institutional system preserved the customs and traditions of the people, and the ruler is at the apex of a system.

## **BASIS OF METHODOLOGY**

Fletcher (1996) had published on a well-known 'tree of architecture' in which different styles of the Western architecture were classified according to façade style, era or period, technology, structure and building ornamentation. He had chronologically classified them into styles and language including architectural form. In his classification, what governed the classification was the more symbolic buildings of the society or civilisation, such as palaces, churches and forts rather than houses. In the traditional Malay style, there is generally an abundant use of columns, pitched roofs, naturally ventilated porticos, louvres, tall windows, adornment of roof finials, and decorative panels, and thus a common pattern that can be identified and variations can be derived from the 'generic'. These variants reflect local resources and the skills of their societies and are derivative of local socio-political systems. Based on measured drawings and digital information gathered, a series of elevational and spatial-morphological studies were undertaken through observing the character of the façade and associated layouts. Both facades and the spaces directly behind the facades are of interest. The cases are derived a range of multiple centres in Peninsular Malaysia and East Sumatera built from 1600 to 1930, similarities in archetypical forms are observed and grouped according to similarities in character. Regarding the era, the cases were focused from 1800 onwards to 1930, yet one old mosque is traced

as far back as the 1600s. The significance of the 1920s as a cut-off point is as highlighted by Gullick (1987) who provided a key insight into the times, ‘...*The nineteenth century appears to have been the large age of unchanging stability and the twentieth-century marks the beginning of accelerating processes of social change which continue to own to modern times. The end of an epoch and the beginning of another cannot be dated precisely, but one can recognise that say by 1920, age had ended, and another had begun.*’

The methodology of deriving generic forms refers to Clark and Pause (2012). They had similarly mapped architectural configurations in terms of themes and intentions and used a research methodology based on design analysis and shape. The methodologies being adapted in this study is similar; the shape of layouts and facades are linked to different types, and are expressed as formative ideas and simple diagrams. These simple diagrams or abstractions are intended to convey the essential characteristics and relationships in order to focus on specific physical attributes which essentially represent the building’s architecture, style, type, proportion, scale and facade expression. The diagrams are developed as two and three- dimensional forms including the overall space layout and configurations of the facades. This research is not exhaustive; but will progressively include examples to illustrate both the fundamentals and nuances of the idea and theory. The analysis of palatial configurations, façades and forms derived from the consequence of multiple interpretations, dominant patterns and formative features of these buildings.

## **RESULTS**

Based on the analysis, the study initially identifies the ‘generic’ and limited variations of frontages, and had divided these into five essential typologies or archetypes (Figure 2). These archetypes are seen as formal characterisation of its elevations and these archetypes are supported by similar patterns in the observed spatial layout. In all cases, the study initially mapped fully timber palaces which constitute the essential roots of the Malay world. The palaces are then organised according to morphology or shape of roof, body or base. Variations due to the evolution of time are also mapped and the changes in the elevational language from the essential timber to the essentially masonry vocabulary and expressions are mapped. Below are the observed basic typologies, or archetypical forms which can be arguably identified as reflecting several forms.

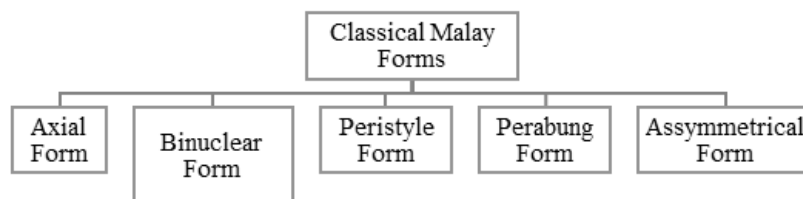


Figure 2: Observed typologies of classical Malay forms

### The 'Axial' Form

This form represents a frontal elevation character which is axial and whose center contains the highest point of the frontage. The centre point or central axis is typically, the midpoint and is the highest point of the façade. Both layout and façade form itself demonstrates the predominance of a centrally located heightened space with a dominating central axis in a generally symmetrical form. Its generic shape exhibit a clear hierarchy of massing and spaces. This form mainly consists of a dominant centre axially divided in a symmetrical arrangement. The middle portion is typically elongated into either an enclosed or semi-opened pavilion, which functionally, facilitates the duties of the monarch or administration members to view or hold public events and to gather (Figure 3 and 4). While the back portion is either a '*bumbung panjang*' or '*bumbung limas*', at times there are variants such as the Minangkabau variant or Kalimantan variant. The simplest generic type may refer to the all timber structure, Istana Malige, Sulawesi and a hybrid variant, the '*Istana Langkat*' is a compact axial form, extended porticoes and is surmounted by a multiple layered pitch roof.

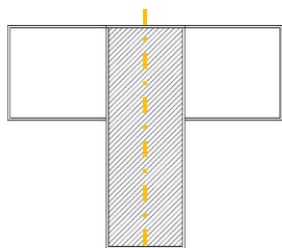


Figure 3: Typical plan of 'Axial Form'

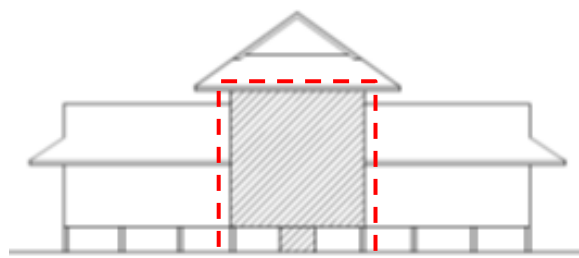
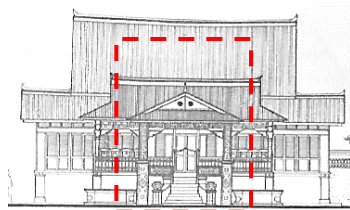


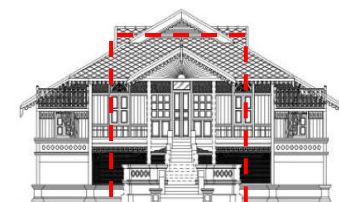
Figure 4: Typical elevation of 'Axial Form'

Further variants are hybrid palaces consisting of timber and masonry structures with a rich treatment such as the Rumah Panglima Ghani (Figure 5). Other variants from the near region is the include Istana Lima Liras, Batu Bara and Istana Langkat, both in Sumatera. All recall the multispaces and extensions of the extinct Melaka Palace, which consists of a series of '*anjung*' or 'closed' porticos at the left and right of an imposing dominant central entrance and

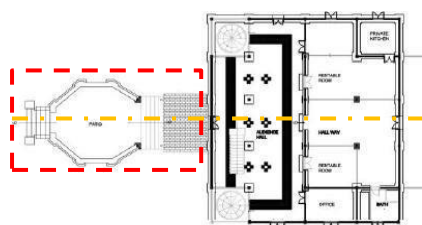
protruding balcony or covered balcony. Smaller versions are the Bytun Anwar of Perak (Figure 6, 7 and 8) and the Istana Nyaring, Pattani. At the end of the scale of colonial hybrid is Istana Bandar, of Kelang or Jugra (Table 1).



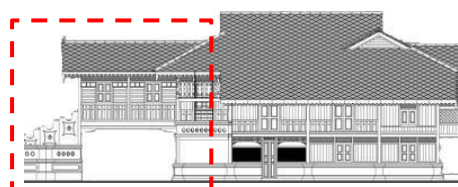
**Figure 5:** Rumah Penghulu Ghani, Melaka  
 Sources: KALAM UTM  
 \*Dotted lines by author



**Figure 6:** Bytun Anwar, Perak  
 Sources: Heritage KAED, IIUM  
 \*Dotted lines by author



**Figure 7:** Central entrance with equal elements at left and right of the building  
 Sources: Heritage KAED, IIUM  
 \*Dotted lines by author

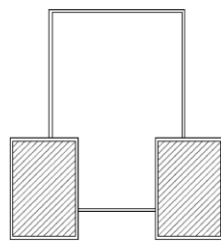


**Figure 8:** Bytun Anwar - Axial form with protruding structure at the centre  
 Sources: Heritage KAED, IIUM  
 \*Dotted lines by author

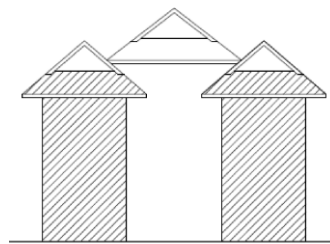
### The 'Binuclear' Form

As defined by Clark and Pause (2012), binuclear form is a configuration pattern with two equally dominant parts. In this morphological studies, the binuclear saw as a massing where the overall form is essentially capped by two dominated roof and these mirror images of one another. Baitul Rahmah front façade shows that the dominant part of the façade is both protruding elements at the right and left the side of the building which is the 'anjung'. The focus of the façade is the balance and extended structure of the building (Figure 9 and 10).

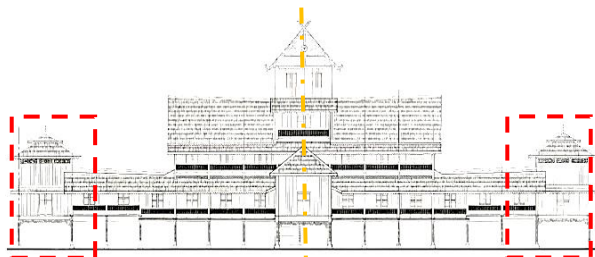




**Figure 9:** Plan of Binuclear Form



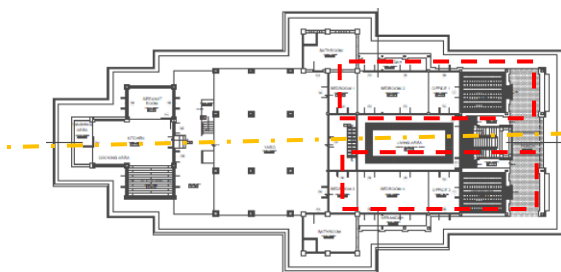
**Figure 10:** Front façade of Binuclear Form



**Figure 11:** Istana Seri Menanti, Negeri Sembilan

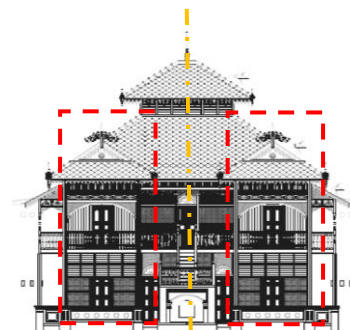
Sources: *KALAM UTM*  
\*Dotted lines by author

The Istana Damnah can be argued as an example of a ‘binuclear’ ‘dual’ form where the masonry staircases on left and right divide the main form into two equal parts. Istana Seri Menanti is another variant, yet it can also be argued as a hybrid axial-dual on a scale of forms between generic types (Figure 11 and Table 1). Other examples are Baitul Rahmah of Perak (Figure 12 and 13), Istana Lima Laras of Batu Bara Sumatera (Figure 14), Istana Darul Aman of Langkat, Istana Leban Tunggal of Pahang and Istana Hulu of Perak (Figure 15).



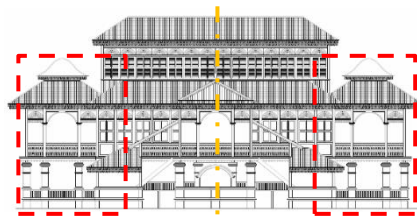
**Figure 12:** Baitul Rahmah, Perak – plan shows the two protruding elements at both at right and left sides of the building.

Sources: *Heritage KAED, IIUM*  
\*Dotted lines by author

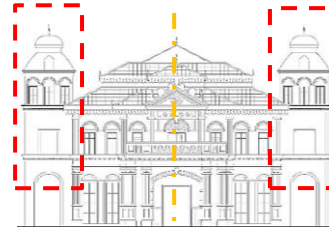


**Figure 13:** Front façade of Baitul Rahmah, Perak

Sources: *Heritage KAED, IIUM*  
\*Dotted lines by author



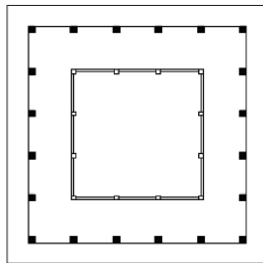
**Figure 14:** Istana Lima Laras, Batu Bara, Sumatera



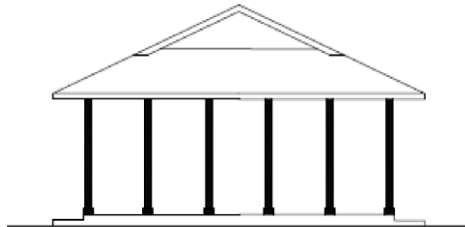
**Figure 15:** Front façade of Istana Hulu, Perak  
 Sources: Heritage KAED, IIUM  
 \*Dotted lines by author

### The Peristyle Form

Peristyle can be defined as a central core shape surrounded by a series of colonnaded walkways or spaces. The peristyle form can be argued as a derivation of the axial form, but with a row of columns surrounding space within a building such as a courtyard or internal garden or edging a veranda or porch (Figure 16 and 17).

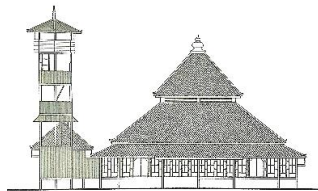


**Figure 16:** Plan of Peristyle Form

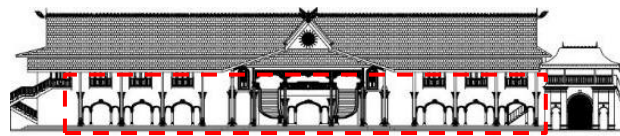


**Figure 17:** Front façade of Peristyle Form

Renowned examples are the Masjid Kampung Laut of Kelantan, whereby a row of columns surrounds the main prayer hall (Figure 18). Closely spaced columns surrounding the ‘Balai Rong’ of the Istana Balai Besar, Kedah is one of an outstanding examples of the peristyle form (Figure 19 and 20). Other examples are Istana Pelalawan, Riau and Istana Lama Johor (presently known as Museum Abu Bakar, Johor Bahru).



**Figure 18:** The Front façade of Masjid Kampung Laut Kelantan  
 Sources: KALAM, UTM  
 \*Dotted lines by author



**Figure 19:** The Peristyle form of Istana Balai Besar, Kedah  
 Sources: Heritage KAED, IIUM  
 \*Dotted lines by author

### The 'Perabung' Form

The 'Perabung Lima' form is distinguished by the unique style of the roof, which resembles a five-sided pyramid (the word 'Lima' means five in Malay) influenced by Dutch-style home architecture to shelter 'anjung' or porticos in Malay building.

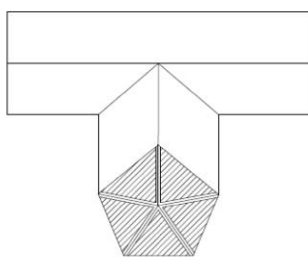


Figure 21: Plan of 'Perabung' Form

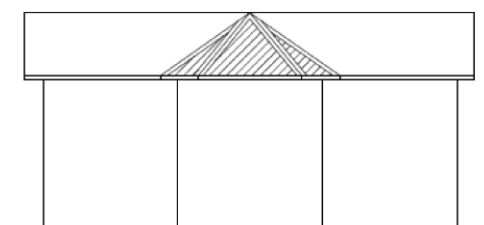
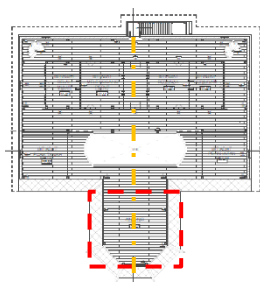


Figure 22: Front façade of Perabung Form

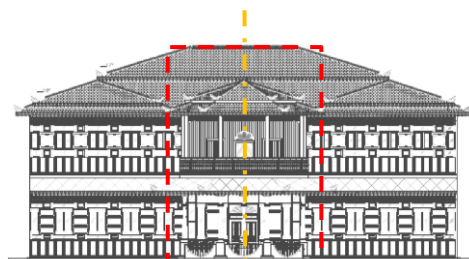
The shape of plans was reflected as 'Perabung Roof Form' and in some cases, it does not look like pyramidal form but more likely dome shape with segmented planes for example Istana Leban Tunggal, Pahang. As long as the forms have segmented planes, pointed up and looks like a pyramid, dome or cone, the building forms can be categorized under 'Perabung Form'. This Malay form or style was usually found in the states of Kelantan, Perak and Terengganu. It was a favoured style by royal families of their palaces (Figure 21 and 22).

The Istana Kenangan in Kuala Kangsar has the same character of the protruding structure with 'Perabung Lima Roof' on top (Figure 25). It was built as an official residence for the Perak royal family. Istana Jahar, differ to Istana Kenangan whereas the ground floor of the protruding area is only columns without no walls (Figure 23 and 24). The palace has a pentagon-shaped portico with the first-floor balcony from which members of the royal family could watch ceremonies held in front of the palace.



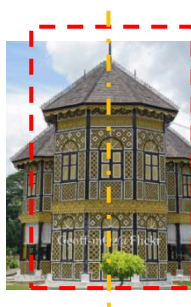
**Figure 23:** Plan of Istana Jahar, Kelantan

Sources: Heritage KAED, IIUM  
 \*Dotted lines by author



**Figure 24:** Front Façade of Istana Jahar, Kelantan

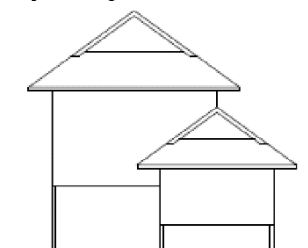
Sources: Heritage KAED, IIUM  
 \*Dotted lines by author



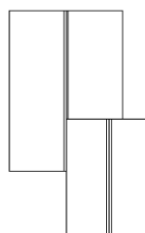
**Figure 25:** Front façade of Istana Kenangan, Perak

### The ‘Asymmetrical’ Form

The ‘Asymmetrical’ form refers to a commonly known form in local architecture often seen in Perak and Kedah, whereby the entrance or ‘*verandah*’ space distinctively occupies one side of the building (Figure 26 and 27).



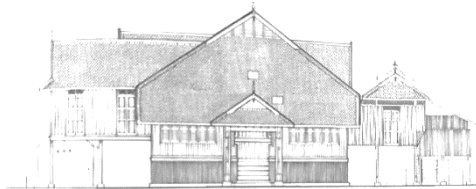
**Figure 26:** Façade of Asymmetrical Form



**Figure 27:** Plan of Asymmetrical Form

The same form is reflected multiple times across Malaysia. The asymmetric form refers to a generic vernacular form, typically seen in typical traditional Malay houses such as the Kutai house, in which the ‘*verandah*’ space is deep and is inserted to one side of the Malay house, over a staircase. This

palatial form is also a characteristic of the vernacular. In this case, the form is a kind of ‘regional’ Classicality and in seen in the larger scale of palaces such as the asymmetric form of the iconic Istana Tengku Long Terengganu which has a deep, elongated ‘*verandah*’ or *serambi* inserted into one side of the palace form (Figure 28). Other examples are the Villa Tengku Kudin, Penang and Dato’s Biji Sura House, Terengganu (Figure 29).



**Figure 28:** Istana Tengku Long,  
Terengganu

Sources: KALAM, UTM  
\*Dotted lines by author



**Figure 29:** Dato’ Biji Sura house,  
Terengganu House

Sources: KALAM, UTM  
\*Dotted lines by author

## SUMMARY

In summary, the general typologies or archetypes observed in the public domain of Malay architecture can be categorized into a series of elevation styles and building forms. Such elevation characteristics remain until today, yet there is a need to continuously classify and define them. These archetypes contain some of the best representation of place, and locale and can be used as templates of public complexes. Together with the delicacy of their treatments, the frontages are physical expressions of the ‘higher’ forms of cultural and aesthetic taste of the Malay society and a reflection of how local architecture and technology had blended and developed over the time. From the analysis of the case studies, these types are described as ‘classical’ Malay forms which can be formulated into five categories of forms as in Table 1, in evolution and language then be classified further into the ‘variants’ based on the building’s elements and its evolution according to the technology and materials of the era and the region. Column 1 shows refer to cases which are constructed wholly in timber, while Column 2 indicates a hybrid with the ground floor or base of the staircase or bottom pillar being made of brick or masonry. The percentage of timber as a building material of component decreases from column 1 to column 5, shows the pressure of modernisation and how the barometer of modernity in reflected in the materials. What is Malay is still categorised within the evolution as the changes did not drastically affect the Malay Forms as a whole because the forms and styles remain the same even though the expressions had been transmuted from timber to masonry. Table 1 only included 25 case studies of aristocrat’s buildings from the Malay World regions (Malaysia and East Sumatra) from the year 1600 – 1920,

which had encapsulated the 5 Malay architecture forms. The building frontages are representative of the era, yet they reflect the breadth of the configurative patterns of the Malay world, and potentially represent models and themes that can be used to design large scale public buildings which should not merely copy imported styles since Malay architecture has its own identity and style.

**Table 1:** Matrix of Malay architecture palaces - forms and its materials

					
	1	2	3	4	5
<div style="display: flex; align-items: center;"> <div style="width: 15px; height: 15px; border: 1px solid black; margin-right: 5px;"></div> Timber  <div style="width: 15px; height: 15px; background-color: gray; border: 1px solid black; margin-right: 5px; margin-top: 5px;"></div> Brick                 </div>					
Axial Form	Istana Melaka	Panglima Ghani House, Melaka	Bytul Anwar, Perak	Dato Biji Sura House Terengganu	Istana Bandar, Selangor
Binuclear Form	Istana Seri Menanti, N Sembilan	Istana Lima Laras, Batu Bara	Baitul Rahmah, Perak	Istana Darul Aman, Langkat	Istana Hulu, Perak
Perabung Lima	Istana Kenangan, Perak	Istana Leban Tunggal, Pahang	Istana Jahar, Kelantan	Istana Bilah, Perak	Istana Ternate, Maluku
Peristyle Form	Masjid Kg. Laut, Kelantan	Istana Inderagiri, Renggas	Istana Damnah, Riau	Istana Balai Besar, Kedah	Istana Sultan Abu Bakar, Johor
Asymmetrical	Istana Tg. Long, Terengganu	Kutai House, Perak	Aristocrat House, Penang	Aristocrat House, Kelantan	Villa Tengku Kudin, Penang

The case studies also suggest organising principles for the regional expression as the generic principles of classical Malay language and the essences of traditional form can be defined, into thematic categories without parochial references and later be seen as universal templates and transmuted into modern buildings and urban cities. What is also observed is there is a prevailing common yet intuitive system of proportion and these can be further studied as the basis of building form and elevational design that represent the region. The features and key patterns highlighted here are mainly founded upon the façade and the structure, which has different centres and axis as focal points which are then organised in different ways to create a balanced hierarchy of the façade systems, whether based on symmetry or asymmetry, or repetition. These frontages also reveal the potential of a locally formed expression of 'classical' orders arranged in a certain hierarchy which are found to vary, yet which can later be typified into themes, types and rules. The result suggests even that a probability of ordering such universal styles into the five orders of a regionally-based Classical design, which exists recall an underlying 'five' orders of Malay architecture which should

be further detailed as generic rules or combinations of the principles and grammar of Malay Architecture for public buildings. These can be used to evoke and transmute Malay Architectural identity in the increasing urbanisation of the region's cities and be reflected into the complexity of buildings for the modern world and its urbanised functions.

## **CONCLUSION**

The significance of advocating a Classical Malay language for the public realm is urgent. This is related to the rising urbanisation of cities in the region and in some nations, the experience of Colonisation has created a rupture between past and present, and produced a vacuum. Without the search for an alternative body of theory, this vacuum will be filled with merely copying the styles and faces of Modernism or other foreign styles not rooted in the region. This research addresses a critical juncture faced by urbanists and policy makers, yet represents only a single part of a larger study. While regional identity holds an emotive link to the locals, the challenge is to rationally analyse what is typically perceived as 'emotive', nostalgic and romanticist. The need to organise principles and vocabulary and hence resources, reveals the capability of transmuting the character of Malay Architecture from the ancient past to the future. This research serves as a starting point to move past the intuitive and emotive into a set of grammar and language, which is crucial in resisting homogeneity and globalisation and instilling identity into cities via modern masonry multi-storey structures. As urbanisation continues its course, the tectonic timber-based vernacular traditions of the region, which are rich and deep in promise, must be studied to derive rules and templates to disseminate, adapt, adopt and transmute such elements and forms into a regional expression within the rising urban and homogenous character of the region. It is also part of the new movement of sustainable modern architecture from which local styles must arise. The goal of ultimately arresting the rapid destruction of local identities in cities amidst globalisation through a universal method of expressing their localities by a forging of a path to bring the past into the 'modern'.

## **ACKNOWLEDGEMENT**

The authors would like to acknowledge the Transdisciplinary Research Fund (**TRGS16-03-001-0001**- Characterization of Rules of Malay Architectural Language) from Ministry of Higher Education for the support of this research.

## **REFERENCES**

- Abd Rashid, M. S., & Che Amat, S. (2009, July). The traditional Malay architecture: Between aesthetics and symbolism. *Seminar on Intellectual Property and Heritage Issues in the Built Environment*. July 20-21, 2009, Kuala Lumpur, Malaysia.
- Amoroso, D. J. (2014). *Traditionalism and the ascendancy of the Malay ruling class in*

- Malaya. Singapore: Singapore University Press.
- Andaya, L. Y. (2010). *Leaves of the same tree – Trade and ethnicity in the Straits of Malacca*. Singapore: NUS Press.
- Clark, R. H., & Pause, M. (2012). *Precedents in architecture: Analytic diagrams, formative ideas, and partis*. Hoboken, NJ: John Wiley & Sons.
- Evers, B., Biermann, V., & Thoenes, C. (2003). *Architectural theory: from the Renaissance to the present*. Köln: Taschen.
- Fletcher, B. (1996). *Sir Banister Fletcher's a History of Architecture*. New York: Architectural Press.
- Gullick, J. M. (1987). *Malay society in the late nineteenth century: The beginnings of change*. Singapore: Oxford University Press.
- Hourigan, N. (2015). Confronting classifications - when and what is vernacular architecture? *Civil Engineering and Architecture*, 3(1), 22-30.
- Ibrahim, M. (2017). The genius of tradition: Palatial classicism in the Malay world. In S. Jahn Kassim, N, Nawawi, & N. Abdul Majid (Eds.), *The resilience of tradition, Malay allusions in contemporary architecture*. Penang, Malaysia: Areca Publishers.
- Jahn Kassim, S., Nawawi, N., & Abdul Majid, N. (2017). *The resilience of tradition, Malay allusions in contemporary architecture*. Penang, Malaysia: Areca Publishers.
- Measured drawings and Heritage Studies*. Kulliyah of Architecture and Environmental Design (KAED) IIUM.
- Measured drawings*. KALAM, Universiti Teknologi Malaysia (UTM).
- Milner, A. C. (2011). *The Malays*. Chichester: Wiley-Blackwell.
- Mohamad Rasdi, M. T., Mohd. Ali, K., Syed Ariffin, S. A. I., Mursib, G., & Mohamad, R. (2005). *The architectural heritage of the Malay World the traditional houses*. Skudai, Johor: Penerbit UTM.
- Nasir, A. H., & Wan Teh, W. H. (1997). *Warisan senibina Melayu*. Bangi: Universiti Kebangsaan Malaysia.
- Porphyrios, D. (1982). *Classicism is not a style* (Volume 52). Michigan: Architectural Design.
- Rae, M. (2017). *Architecture and theology: The art of place*. Waco, Texas: Baylor University Press.
- Reid, A. (2004). Understanding Melayu (Malay) as a Source of Diverse Modern Identities. In *Journal of Southeast Asian Studies*, 32(3), 295-313.
- Shuaib, A. A., & Enoch, O. F. (2013). Application of Kelantan traditional aesthetic values into the architecture of contemporary homes. *Arts and Design Studies*, 6(15), 15-25.
- Summerson, J. (1980). *The classical language of architecture*. London: Thames and Hudson.
- Watkin, D. (2011). *A history of Western architecture*. London: Laurence King Publishing.
- Wong, W. (1995). *Timber structures in Malaysian architecture and buildings* (Master thesis). University of Tasmania, Australia.





## **A REVIEW OF IBS IMPLEMENTATION IN MALAYSIA AND SINGAPORE**

**Asiah Abdul Rahim<sup>1</sup> & Sara Latif Qureshi<sup>2</sup>**

*<sup>1,2</sup>Kulliyyah of Architecture and Environmental Design,*  
INTERNATIONAL ISLAMIC UNIVERSITY MALAYSIA

### **Abstract**

This paper is a review of IBS implementation in Malaysia and Singapore. It investigates the limitations and opportunities in implementation of IBS in Malaysia and Singapore. In Malaysia, Construction Industry Development Board (CIDB) defines Industrialised Building System (IBS) as a construction technique in which components are manufactured in a controlled environment (either onsite or offsite), then transported, positioned and installed into a structure with less additional onsite works. Content analysis is the method adopted in this study. Data is collected from books, journal articles, annual reports and newspaper articles. Studies show that IBS contributes many benefits including labour reduction, cleaner and neater sites, easy installation, fast completion, enhancement of quality finished products and flexibility. Construction industries in countries like Singapore and Malaysia have shifted the construction methods from conventional to prefabrication. In Malaysia, Construction Industry Development Board (CIDB) is still promoting IBS in the private sector, whereas, government sector has successfully adopted IBS. However, in Singapore, Housing and Development Board (HDB) has implemented prefabrication in its construction industry. IBS has many benefits but with these benefits there are some limitations and hindrances as IBS is not widely adopted. This study highlights the benefits and challenges to overcome for the improvement in the implementation of IBS.

**Keywords:** industrialized building system (IBS), prefabrication, construction, Malaysia, Singapore

## **INTRODUCTION**

Malaysia's population reached 32 million in 2017 (Bernama, 2017) and is estimated to grow by 2 million every five years (CIDB, 2016). The residents' population in Singapore was 3.93 million in 2016 and rose 0.8% to 3.97 million at the end of June 2017 (Singapore Department of Statistics, 2017). As the population increases, the demand of housing increases. According to Ismail and Rahim (2009), a system architecture which takes the advantage of new technology could change entire construction industry. However, the conventional method of construction is not efficient enough to cope with the increasing demand for housing. The construction industry has shifted its attention to mass production and prefabrication construction methods to fulfil the rapidly growing need for housing. This strategy motivated Malaysian construction industry to analyze the industries from various countries who have achieved the implementation of prefabrication technology such as United Kingdom (UK), United States (US), Australia, Hong Kong and Singapore (Seik, 2001; NAHB Research Center, 2002; Jaillon & Poon, 2009; Blismas & Wakefield, 2009; Lovell & Smith, 2010; Azman, Majid, Ahamad, & Hanafi, 2011). Prefabrication is not merely focussed on mass production but also delivers a unique product using a systematic approach (Gardiner, 2008).

One of the second largest economic sectors in many developing countries is the construction industry (Preece, Pheng, Padfield, & Papargyropoulou, 2011). The three broad activities in an industry namely residential building, non-residential building and engineering construction. The main factors which play important roles in the residential building sector are the Government policies, the availability of skilled labour and building material resources. Mass House Building Projects (MHBPs) and a sustainable building model for developing countries have introduced initiatives to provide affordable building structures (Ahadzie, Proverbs, & Olomolaiye, 2008).

A sustainable construction is described as a subset of sustainable development, which includes design, tendering, site planning, and organization, material selection, recycling, and waste minimization (Langston & Ding, 2001). Whereas, a conventional construction method is the result of many factors which can be technological, social or financial (Rahim, Hamid, Zen, Ismail, & Kamar, 2012). Conventional construction involves complete on-site work and is unsustainable as it is associated with poor quality and productivity, high risk of worker safety and high dependency on labours. Whereas prefabricated construction or IBS (Industrialised Building System) is a construction method which involves the off-site manufacturing of components in a factory controlled environment which are then transported and assembled into a structure with limited work on construction site. IBS is a sustainable method as the buildings are constructed in a short time span with significantly reduced on-site activities, hence resulting in tremendous savings to the stakeholders. According to Ismail

and Rahim (2009), factory manufactured components are easy to assemble on site, use less labour, faster to construct and are of high quality. The method is beneficial in terms of cost saving, minimizing on-site wastage, safety, high quality work, cleanliness and neatness of on-site work, reduces dependency on manual foreign labours (Pan, Gibb, & Dainty, 2012), provides easy installation and flexible (Aziz & Razuan, 2003).

### **METHODOLOGY**

The method adopted in this study is content analysis. Data is collected from books, newspaper articles, annual reports and journals including Construction Industry Development Board (CIDB) reports, Malaysian Construction Research Journal (MCRJ) by CREAM (CIDB), Population Trends by Department of Statistics Singapore, Circular on Amendments to Building Controls (Buildability and Productivity) by Building and Construction Authority (BCA) Singapore and Australian Journal of Basic and Applied Sciences.

### **BACKGROUND STUDY**

#### **Malaysia**

IBS in Malaysia has been initiated since 1960s to overcome the shortage of houses. However the application of IBS was at infancy and not fully adopted. In late 1960s and early 1970s, some of the international IBS systems were introduced but these systems were found to be incompatible with the climatic condition in Malaysia hence resulted in the closure the precast concrete factories and conventional method had still to be applied (Hamid, Kamar, Zain, Ghani, & Rahim 2008). In some cases, the budget was exceeded, targeted completion dates were not achieved, and the quality was not always up to expectation. Apart from encouraging the use of IBS in Malaysia, it is the government's objective to dwindle the dependency on foreign labour and save country's loss in foreign exchange in the Malaysian construction industry (Hamid et al., 2008; Hussein 2007). However, in 1999, due to lack of local skilled workers and overflow of unskilled foreign workers, the country recognized that use of IBS is the only solution to overcome these issues. The first IBS strategic plan was announced followed by two IBS "Roadmaps" i.e. 2003-2010 and 2011-2015 (CIDB, 2016). Since then, it is mandatory for government projects to comprise of at least 70% of IBS components (Khalil, Aziz, Hassim, & Jaafar, 2016). However, IBS is still not widely implemented in private sector. Therefore, the main issues are still unsolved despite the initiatives by the government using IBS system.

Many countries such as Singapore have adopted the IBS or prefabrication and its benefits have been well-documented. IBS is then recognised as a complete process system of construction which includes the manufacturing of almost all

the component structures at a place other than the main site. The components are then transported and assembled to achieve high quality works with the reduction in completion time of the projects. Haroon, Rahman and Hanid (2009) define IBS or industrialised building system as the concept of mass production of quality building. However, Abdullah and Egbu (2009) define IBS as a method of construction developed by human investment in innovation and on reconsidering the best ways of construction work deliveries grounded on the level of industrialization. Whereas, Kamar et. al (2009) create a conceptual definition of IBS as an innovative process of building construction which uses the idea of mass-production of industrialised systems, produced at the industry or on-site within controlled environments, executed in proper coordination with rigorous planning and integration. Yunus and Yang (2011) highlights five standard characteristics of IBS i.e., prefabrication, offsite production, mass production, standardized components and design using modular coordination.

Malaysia's entire domestic construction labour force comprises of 25% foreign workers compared to an average of 13% in all other sectors (CIDB, 2016). Foreign workers levy in the manufacturing and construction sectors has been doubled from RM1,250 to RM2,500, a way to reduce over-reliance on low skilled foreign labour (CIDB, 2016). Khalil et al. (2016) found that the implementation of IBS in construction industry in Malaysia is less due to the unwillingness of the stakeholders because they are not convinced with the IBS system. The government aims to make it compulsory for the contractors to implement IBS by the year 2020. However, the move faces various challenges. A survey conducted by CIDB shows that the implementation of IBS by the private sector is still deficient around 15% and the government aims it to be higher about 70% (Yunus, 2017). One of the issues raised by the contractors is the lack of economies of scale. The contractor has to incur high initial costs for lifting and transporting the prefabricated components to the construction site (Yunus, 2017).

## **SINGAPORE**

Many countries, including Singapore, at different levels of development, have recently formulated long-term plans to improve their construction industries. Singapore has a successful construction industry development agency which was formed in 1984 initially as Construction Industry Development Board (CIDB) and became Building and Construction Authority (BCA) in 1999 (Ofori, 2000). BCA is a government agency. In Malaysia, most of the housing are funded and developed by the private developers. However, in Singapore, the government develops most of the residences. Housing and Development Board (HDB) manages the Public accommodation in Singapore. Depending on the end-users needs, there are several options for Singapore homeowners. There are three most popular types of residential units in high-rise buildings in Singapore, namely, BTO (Built-to-Order), DBSS (Design, Build and Sell Schemes) and EC

(Executive Condominium). HDB offers BTO flats for sale which are public housing flats, private developers build DBSS which are also public housing flats and EC is one that is constructed and sold by private developers. Comparing costs, BTOs (the housing by HDB) are the most affordable than the other two, whereas ECs are the most expensive option.

Singapore experienced failures in the early stage of adoption of prefabrication technology (Thanoon, Peng, Kadir, Jaafar, & Salit, 2003). The increasing demand of apartments in the early 1960s prompted the Housing and Development Board (HDB) of Singapore to adopt the IBS concept. Because of the critical need, the HDB launched the first prefabricated method of construction in 1963 using a trademarked French large panel and fabrication system on 10 blocks of standard 16 storey flats. However the project faced many technical and management issues and had to be completed by the conventional method (Malaysia Equity Research, 2014). Then, in 1973, HDB took initiatives to re-attempt the IBS. In 1979 HDB introduced significant innovations in new building systems which includes Ferro-cement cladding system, prefabricated bathroom units (PBUs), precast pre-stressed composite floor system, architectural precast facades as well as pre-cut and pre-bend reinforcement bars (Malaysia Equity Research, 2014)

Singapore is now moving its concern toward PPVC (Prefabricated Prefinished Volumetric Construction). It is a construction method whereby free-standing volumetric modules (complete with finishes for walls, floors and ceilings) are manufactured and assembled by fabrication method and then installed under building works (BCA, 2015). The use of PPVC is mandatory for selected no-landed residential Government Land Sale (GLS) sites from 1<sup>st</sup> Nov 2014 (BCA, 2015). HDB announced that by 2019, 35% of newly launched housing board projects will be built using PPVC and all BTO flats will be pre-fitted with pre-assembled bathroom units with copper piping, partial tiling, window frames and waterproofing systems (“HDB to expand use of prefabrication”, 2017).

#### **ADVANTAGES AND LIMITATIONS IN IMPLEMENTATION OF IBS**

Mohammad, Baharin, Musa and Yusof (2016) found that modular system can reduce construction time and wastage but at the same time high initial costs and lack of technical expertise are the major hindrances to the implementation of IBS. Since IBS is facing many issues such as poor quality and lack of skill and technology, the focus should be on improving the use of IBS rather than maximizing its use (Gibb, 2001). Following are the advantages (Table 1) and the limitations (Table 2) categorized in the form of tables including the findings, authors and years.

**Table 1:** Advantages of IBS

No.	Advantages	Findings	Authors
1.	Time saving	IBS or prefabrication method is good as it reduces construction time.	Marsono et al., 2006; Rahim & Ismail, 2011; Koenigsberger, 1986; Thanoon et al., 2003
2.	Quality improvement	IBS will produce better quality products as it promises high level of expertise throughout the industry	Azman et al., 2010; CIDB, 2003; Din, 1984
3.	Labour reduction	Reduces labour on site, involves higher mechanization due to repeatability process.	Azman et al., 2010; Warszawski, 1999; Koenigsberger, 1986
4.	Reduction of remittances by foreign labour	Reduces the remittances by foreign labours.	Bernamea, 2006
5.	Cost reduction	IBS can be cheaper than using conventional methods as it reduces labour cost, in addition to this, the repetitive use of system formwork provides significant cost savings.	Haroon et al., 2009; Gann, 1996; Bing et al., 2001
6.	Efficient construction process and higher productivity	IBS will help to enhance efficiency of construction process allowing high productivity.	CIDB, 2004
7.	Wastage reduction	IBS offers minimum wastage and less site materials as it enables offsite or prefabricated components manufactured at factories, thus resulting in neater and cleaner environment.	CIDB, 2003
8.	Flexible design	IBS allows flexibility in design of precast elements as well as in construction so that different systems may produce their own prefabrication construction methods.	Omar, 2000
9.	Adverse weatherproof construction	Because of the manufacture of components in a factory controlled environment, the construction operation is not	Thanoon et al., 2003

---

affected by adverse weather conditions.

---

The implementation of IBS is still deficient in the construction industry compared to the conventional method. Due to some previous low-quality IBS construction projects, there are some negative perceptions of different parties involved that lead to the limitations in the use of IBS as highlighted in Table.2.

**Table 2:** Limitations in IBS implementation

No.	Limitations	Findings	Authors
1.	Time	Delay due to improper planning and conventional procurement approach.	Mohammad et al., 2016
2.	Skills shortage	Unskilled labours in IBS systems, lack of technical expertise.	Mohammad et al., 2016
3.	Poor Quality	Previous IBS projects were of low quality and high construction costs.	Haroon et al., 2009; Mohammad et al, 2016
4.	Cost	Cost overrun/ high initial costs	Mohammad et al., 2016
5.	Lack of small contractors' involvement	Small contractors are familiar with conventional method and and addition to this, due to lack of financial backup, they are unable to set their own manufacturing plant.	Haroon et al, 2009; Rahman & Omar, 2006
6.	IBS as mass construction method	It is always linked with poor quality industrialised buildings built in 1960s. Poor architecture and old prefab buildings have negative impact on public.	Rahman & Omar, 2006
7.	Technology	Machinery redundancy	Mohammad et al., 2016
8.	Lack of Awareness	Many architects and engineers are still unaware of the essential elements of IBS such as Modular co-ordination, due to lack of awareness and incentive from Government in promotion of IBS.	Haroon et al., 2009
9.	Lack of Knowledge	There is a lack of R&D in new building systems that use local materials.	Haroon et al., 2009; Rahman & Omar, 2006
10.	Lack of Scientific Information	Insufficient evidence to prove the benefits of IBS, thus, due to lack of scientific information the implementation of IBS is delayed.	Badir et al., 2002

## CONCLUSION AND RECOMMENDATIONS

The benefits of IBS are well-documented. However, the pace in the implementation of IBS in construction industry of Malaysia appears to be slower than expected. Based on the literature review, the advantages would give added values to the application of IBS instead of the barriers. These barriers are due to negative perceptions which can be overcome with the support of the government as well as the industry itself. IBS is no doubt, suitable for building functions that require mass production such as housing. The off-site construction has fast time frames, so this may be applied to the projects which have typical floors, which need more standardized and uniform design solutions. It provides neater and cleaner sites. Moreover, the IBS needs to be continuously improved with regards to quality, productivity, labour, safety, research invention and inferior working conditions. On the other hand, the universities having the faculty of Built Environment, for example, Architecture, Structural Engineering and Civil Engineering, should emphasize and promote the awareness and knowledge of Industrialised Building System (IBS). This would reduce the negative perceptions of IBS and subsequently increase the willingness to adopt IBS in construction industry.

## REFERENCES

- Abdullah, M. R., & Egbu, C. (2009). IBS in Malaysia: Issues for research in a changing financial and property market. *BuHu 9th IPGRC: Salford, UK*, 15-25.
- Ahadzie, D. K., Proverbs, D. G., & Olomolaiye, P. (2008). Model for predicting the performance of project managers in mass house building projects. *JCEM, American Society of Civil Engineers*, 134(8), 618-629.
- Aziz, S. N., & Rauzan, N. F. (2003). IBS Survey 2003: Survey on the usage of industrialized building systems (IBS) in Malaysian construction industry. Kuala Lumpur: CIDB.
- Azman, M. N. A., Ahamad, M. S. S., & Hanafi, M. H. (2010). The common approach in off-site construction industry. *Australian Journal of Basic and Applied Sciences*, 4(9), 4478-4482.
- Azman, M. N. A., Majid, T. A., Ahamad, M. S. S., & Hanafi, M. H. (2011). A study on the trend of the use of IBS components and the setting UP of IBS manufacturing factories in the Malaysian construction industry. *Malaysian Construction Research Journal* 9(2), 18-30.
- Badir, Y. F., Kadir, M. R. A., & Hasim, S. (2002). Industrialized building system construction in Malaysia. *Journal of Architectural Engineering*, 8(1), 19-23.
- BCA (2015). *Circular on amendments to building control (buildability and productivity)* (APPBCA-2015-13). Singapore: Author.
- Bernama (2006). *Local construction industry urged to use IBS*. Retrieved from <http://www.bernama.com/bernama/v3printable.php?id=185301>



- Bernama (2017, July 15). Malaysia's population climbs to 32 Million. *Star Online*. Retrieved from <https://www.thestar.com.my/news/nation/2017/07/15/malaysias-population-climbs-to-32-million/>
- Blismas, N., & Wakefield, R. (2009) Concrete prefabricated housing via advances in systems technologies: Development of a technology roadmap. *Engineering Construction and Architectural Management*, 17, 99-110.
- Bing, L., Kwong, Y. W., & Hau, K. J. (2001). Seismic behavior of connection between precast concrete beams. *CSE Research Bulletin*, 14.
- Construction Industry Development Board [CIDB] (2003). *Industrialized building system (IBS): Roadmap 2003-2010*. Kuala Lumpur: CIDB Publication.
- Construction Industry Development Board [CIDB] (2004). Dirty, difficult and dangerous? Simplify it use IBS. Available at [www.cidb.gov.my/content.php](http://www.cidb.gov.my/content.php)
- Construction Industry Development Board [CIDB] (2016). Industrialised building system: The path to enhanced productivity. *Heights*, 3.
- Din, H. (1984). Industrialized building and its application in Malaysia. In *Proceedings of Seminar on Prefabrication of Building Construction, Kuala Lumpur*.
- Gann, D. E. (1996). Construction as a manufacturing process? Similarities and differences between industrialized housing and car production in Japan. *Construction Management and Economics*, 14, 437-450.
- Gardiner, J. (2008) *Exploring prefabrication - International study of prefabrication within aerospace, shipbuilding, automotive and construction industries*. 10.13140/RG.2.2.31808.94724.
- Gibb, A.G.F. (2001). Standardization and pre-assembly- distinguishing myth from reality using case study research. *Construction Management and Economics*, 19, 307-315.
- Hamid, Z. A., Kamar, K. A. M., Zain, M. Z. M., Ghani, M. K., & Rahim, A.H.A. (2008) Industrialized building system (IBS) in Malaysia: The current state and R&D initiatives. *MCRJ, CREAM* 2(1), 1-11.
- Haroon, N. A., Rahman, H. A., & Hanid, M. (2009). A literature review of advantages and barriers to the implementation of industrialized building system (IBS) in construction industry. *Malaysian Construction Research Journal*, 4(1), 10-14.
- HDB to expand use of prefabrication building methods in BTO projects. (2017, September 6). Retrieved from <http://www.channelnewsasia.com/news/singapore/hdb-to-expand-use-of-prefabrication-building-methods-in-bto-9189786>.
- Hussein, J. (2007). Industrialised building system: The challenges and way forward. In *Construction Industry Research Achievements International Conference (CIRAIC 2007)*. Kuala Lumpur: CIDB.

- Ismail, Z., & Rahim, A. A. (2009, October). Implementing built environment research findings in developing countries – the case study of East and Southern Africa. *International Symposium on Construction in Developing Economies: Commonalities among Diversities*. October 5-7, 2009, Penang, Malaysia.
- Jaillon, L., & Poon, C. S. (2009). The evolution of prefabricated residential building systems in Hong Kong: A review of the public and the private sector. *Automation in Construction*, 18, 239-248.
- Kamar, K. A. M., Alshawi, M., Hamid, Z.A., Nawi, M. N. N., Haron, A. T., & Abdullah, M. R. (2009). Industrialized building system (IBS): Revisiting the issues on definition, classification and the degree of industrialization. In *Construction Industry Research Achievements International Conference (CIRAIC 2007)*. Kuala Lumpur: CIDB.
- Khalil, F. D. A. A., Aziz, F. N. A. A., Hassim, S., & Jaafar, M. S. (2016). A Review on Industrialized Building System Issues in Malaysia. *MATEC Web of Conferences*, 47, 04019.
- Koenigsberger, O. (1986) Third World housing policies since the 1950s. *Habitat International*, 10(3), 27-32.
- Langston, C. A., & Ding, G. K. C. (2011). *Sustainable practices in the built environment*. London: Routledge.
- Lovell, H., & Smith, S. J. (2010). Agencement in housing markets: The case of the UK construction industry, *Geo-forum*, 41, 457-468.
- Malaysia Equity Research (2014). *Construction IBS - Practical solution to rising costs*. Kuala Lumpur: MIDF Amanah Investment Bank Berhad.
- Marsono, A. K., Tap, M. M., Ching, N. S., & Makhtar, A. M. (2006). Simulation of industrialized building system components production. In *Proceedings of the 6th APSEC* (pp. 87-96). Kuala Lumpur, Malaysia.
- Mohammad, M. F., Baharin, A. S., Musa, M. F., & Yusof, M. R. (2016). The potential application of IBS modular system in the construction of housing scheme in Malaysia. *Procedia - Social and Behavioral Sciences*, 222, 75-82.
- NAHB Research Center (2002). *Technology roadmap: Whole house and building process redesign (year one progress report)*. Washington, DC: PATH.
- Ofori, G., (2000). *Challenges of construction industries in developing countries: Lessons from various countries*. Retrieved from <https://www.irbnet.de/daten/iconda/CIB8937.pdf>
- Omar, Z. (2000). Malaysian construction industry, challenges and demand. *Malaysian Structural Steel Association Convention Report*. Kuala Lumpur, Malaysia.
- Pan, W., Gibb, A. G. F., & Dainty, A. R. J. (2012). Strategies for integrating the use of offsite production technologies in housebuilding. *JCEM*, 138(11), 1331-1340.

- Preece, C., Pheng, L., Padfield, R., & Papargyropoulou, E. (2011, June). Developing and marketing sustainable construction services, *Management & Innovation for a Sustainable Built Environment*. June 20-23, 2011, Amsterdam, The Netherlands.
- Rahim, A. A., & Ismail, Z. (2011). *IBS towards open building system in Malaysia*. Kuala Lumpur, Malaysia: IIUM Press.
- Rahim, A. A., Hamid, Z. A., Zen, I., Ismail, Z., & Kamar, K. A. M. (2012). Adoptable housing of precast panel system in Malaysia. *Procedia - Social and Behavioral Sciences*, 50, 369-382.
- Rahman, B. A., & Omar, W. (2006) Issues and challenges in the implementation of industrialized building systems in Malaysia. In *Proceedings of the 6<sup>th</sup> APSEC*. Kuala Lumpur, Malaysia.
- Seik, F. T. (2001). Planning and design of Tampines, an award-winning high-rise, high-density township in Singapore. *Cities*, 18(1), 33-42.
- Singapore Department of Statistics (2017). *Population Trends 2017*. Singapore: Author.
- Thanoon, W. A., Peng, L. W., Kadir, M. R. A., Jaafar, M. S., & Salit, M. S. (2003). The experiences of Malaysia and other countries in industrialized building system. In *International Conference on Industrialized Building Systems* (pp. 255-261). Kuala Lumpur, Malaysia.
- Thanoon, W. A., Peng, L. W., Kadir, M. R. A., Jaafar, M. S., & Salit, M. S. (2003). The essential characteristics of industrialized building system. In *International Conference on Industrialized Building Systems* (pp. 283-295). Kuala Lumpur, Malaysia.
- Warszawski, A. (1999). Industrialized building system: Prospect in Malaysia. In *Proceedings of World Engineering Congress, Sarawak, Malaysia*.
- Yunus R., & Yang, J. (2011). Sustainability criteria for Industrialized Building Systems (IBS) in Malaysia. *Procedia Engineering*, 14, 1590-1598.
- Yunus, R. (2017, September 14). Ajiya engages learning institutions to spur ibs adoption. *The Malaysian Reserve*. Retrieved from <https://themalaysianreserve.com/2017/09/14/ajiya-engages-learning-institutions-spur-ibs-adoption/>



## **A COMPARATIVE REVIEW OF DESIGN REQUIREMENTS FOR NATURAL SMOKE VENTILATION IN HOSPITAL BUILDINGS**

**Mohd Zaid Ab Ghani<sup>1</sup> & Srazali Aripin<sup>2</sup>**

*<sup>1,2</sup>Kulliyyah of Architecture & Environmental Design*  
INTERNATIONAL ISLAMIC UNIVERSITY MALAYSIA

### **Abstract**

Smoke is recognized as the main factor of fatality when fire occurred in a building. Thus, smoke management in the building is of paramount importance in order to achieve a tenable indoor environment in the event of fire other than ensuring passive means of escapes to the place of safety. In hospital building, where patients have limited movements, natural smoke ventilation through windows is the most common form of smoke control design. Nevertheless, inappropriate design of natural smoke ventilation through window may result to poor smoke air flow contributing to unwanted toxic gases inhaled by occupants that lead to fatalities in the event of fire. This study aims to analyse the design requirements and specifications of natural smoke ventilation system in buildings by exploring local and other prominent building regulations as well as code of practices around some countries. The study found that smoke ventilation system (natural and mechanical) is usually applied in windowless building, basement and in large open spaces. The natural smoke ventilation system employs smoke vents (gravity vents) located at a higher level in the roof or at the ceiling level. The regulations state that the size of smoke vents for effective natural smoke ventilation is in between 2% to 3% of the floor areas. Most regulations would allow openable windows for smoke ventilation in the event of fire.

**Keywords:** natural smoke ventilation, smoke vent, hospital, windowless

## **INTRODUCTION**

Uncontrolled fire is one of the catastrophic accidents in hospital building that threatens the life of occupants particularly patients, staff, visitors and other users. There have been many cases in the past where uncontrolled fire in hospital had caused injuries and deaths (Kulkarni, Giri, & Gangwal, 2016; Jalali, Asl, Mehr, Pourafzali, & Ghasemi, 2016). In built environment, fire cases would be a huge threat to human life in a closed environment and workplace especially in public healthcare facilities (Krol, 2011; Hui, 2013; Kulkarni et al., 2016). Hospital is a place where people come to seek for treatment of various illnesses and for emergency situations. Vulnerable people like the elderly, children, and pregnant mothers, patients with physical and mental disabilities are greatly affected by the danger of fire in hospitals. They need a longer time to escape or be evacuated to safer place due to their weaknesses and mobility impairments. It has been accepted by many researchers in the field of healthcare facilities that the complexity of functions and services of hospital are due to (1) the availability of vulnerable patients, (2) the presence of potentially hazardous materials and (3) the need for the patients to be consistently assisted (Bongiovanni, Leo, Ritrovato, Santoro, & Derrico, 2017). Therefore, safety against fire in hospital buildings is of paramount importance.

Fire safety design (passive as well as active) is an important element to protect the life of occupants during fire. It refers to fire prevention, reduction of fire and smoke spread, fire extinguishment and achieving a quick and safe exit (Kobes, Helsloot, Vries, & Post, 2010). In the event of fire, the key hazardous product of combustion such as smoke must be controlled and ventilated, so that people are not severely exposed. The hazards of smoke are; elevated temperature, toxicity and low visibility (Li, Su, & Tsai, 2016). Smoke can be a major contributor to fatalities in fire (Tancogne-Dejean & Laclémence, 2016; Ji, Gao, Fan, & Sun, 2013; Chan, 2004; Yatim, 2009; Strating, 2013) and smoke management system plays a significant role in maintaining safety of occupants when fire occurred in hospital building (Partridge, 2013). During fire, evacuating patients to a safe place is not only difficult but time-consuming process as well. Therefore, providing a good and sufficient smoke control system should be considered such as adopting Available Safe Egress Time (ASET) when designing hospital (AAMA, 2010).

Natural smoke ventilation by means of window design is the most common form of smoke control system in hospital buildings particularly wards. However, inappropriate design of natural smoke ventilation through window may result in poor smoke air flow contributing to unwanted toxic gases inhaled by occupants during fire.

Although a natural ventilation design can provide an interior airflow path, it may also have adverse impacts on the way how fire spread and smoke flows in the event of fire in a building (Lai, Chen, Tsai, Tsai, & Lin, 2013). Inappropriate

natural smoke ventilation strategy (window design) in the event of a fire situation may contribute to fatalities due to stack effect (Su, Huang, Lin, & Lin, 2014), strong wind at high level of the supertall building may accelerate the fire and smoke development (Yue, Chow, Fong, & Kong, 2016) and promoting fire severity due to increase oxygen supply (Chen, Liu, & Chow, 2009). Natural ventilation design has two contradictory effects on fire as it promotes fire severity by supplying oxygen and cooling the fire by dilution of smoke (Chen et al., 2009). Also, an experiment conducted by National Institute of Standards and Testing (NIST) on the impact of large openings of windows on fire has resulted in a greater Heat Release Rate (HRR) (Kerber, 2010). According to Wojciech & Grzegorz (2017), the sole possibility for natural smoke ventilation design using windows along the parameter façade as smoke ventilators is not recommended in most buildings because it can lead to non-effective smoke ventilation. However, preliminary findings based on the literature review shows that natural smoke ventilation design (i.e. window design) has an impact on fire safety unless there are some appropriate design approaches to alleviate those effects.

Providing appropriate natural smoke ventilation design for fire safety in a hospital ward is a challenging task and requires careful consideration. Code requirements with regard to smoke exhaust system must be understood by healthcare designers in order to ensure safety of the people in hospital ward during fire. Therefore the local and prominent international regulations and code of practices on natural smoke ventilation design should be reviewed and analysed to achieve appropriate design specifications and applications for hospital buildings in order to create a tenable condition in the event of fire.

### **FIRE ISSUES AND FIRE CASES IN HOSPITALS**

There are a number of hazards in hospitals that threaten patient safety, for example, disease infection, and delay of medical treatment, slip, electricity failure, fall, and fire (Hui, 2013). Fire in hospital buildings has claimed many lives as well as causes injury to many people (Ong & Suleiman, 2015). In Malaysia, there were approximately 209 cases of fire occurred in hospitals and clinics between the year 2010 and the year 2016 (JBPM, 2017). The incidents often lead to serious adverse effects on the building occupants, visitors, and properties. The most catastrophic case in Malaysia was fire at Intensive Care Unit (ICU) ward in Sultanah Aminah Hospital, Johor Bharu, Malaysia. The fire broke out at 9 a.m. on 25 October 2016, where six patients were killed. The victims (four female and two male) were in-patients at Intensive Care Unit (ICU) located at the second floor of the hospital's main building. Initially, seven patients were trapped, but only six were reported perished in the blaze. Another patient was successfully rescued with 80% of his body burnt. Apart from that, two hospital staff members suffered serious injuries. It is believed that the victims died due to suffocation of the thick smoke, which rapidly spread throughout the ward.

On December 9, 2011, another massive fire occurred at Advanced Medicare and Research Institute (AMRI) Hospital, Kolkata, India. 90 people were reported choked to death (Pal & Ghosh, 2014). The hospital was centrally air-conditioned building and it was turned-off due to the electricity failure. When fire starts, smoke began to accumulate into the hospital wards and in escape route. There were no windows in the ward except fixed glass walls for natural lighting. The hazardous smoke subsequently could not be removed from the building (Pal & Ghosh, 2014) and patients in the wards and Intensive Care Unit (ICU) were suffocated and died due to lack of smoke control (Nagral, 2012). The fire began in the hospital basement, where highly flammable gases and liquids were improperly stored. Smoke filled up rapidly in most spaces in the hospital and the windows were locked at that time. Staff had to break the window in order to remove the thick smoke. Unfortunately, most of the people died were due to smoke inhalation.

The Required Self Egress Time (RSET) is a critical period of time that need to be considered to safeguard the life of people in the building. The RSET is the time duration taken by occupants to get to the place of safety in the event of fire before condition become untenable. Kobes et al. (2010) found that fire involving fatalities primarily occurred at night in buildings accommodated by people with disabilities, such as nursing homes, hospitals, residential and prisons. Ong and Suleiman (2015) identified mistakes and problems of fire accidents across the world in hospital building constructed from the year 1918 to the year 2013. The mistakes include lack of automatic fire protection installations, lack of law enforcement, poor planning, poor maintenance and management in fire safety, poor performance of staff, combustible material and conflict between security and fire safety. On the same note, investigation carried out by Ong and Suleiman (2015) in four public hospitals in Malaysia found that documentation issues, use of combustible and flammable materials, lack of fire safety installations, locked doors and windows due to security reasons and lack of training of hospital staff are the factors contributing to fire.

### **THE ROLES OF NATURAL SMOKE VENTILATION DESIGN IN HOSPITAL BUILDING**

Natural smoke ventilation design has significant influence in the safety of people in a building (i.e. hospital) by: (1) extending the time available for people to escape from the building, so-named Available Safe Evacuation Time (ASET), (2) by alleviating the threat posed by smoke produced during fire; (3) reducing the fire growth by lowering down the temperature of the smoke thus limiting the radiation towards flammable materials in the building; (4) facilitating the firefighting operations in the building by reducing the amount and the temperature of smoke inside of the building (Wegrzynski & Krajewski, 2017).

## **A COMPARATIVE REVIEW OF REGULATIONS AND CODE OF PRACTICES ON NATURAL SMOKE VENTILATION DESIGN IN BUILDING**

### **Uniform Building By-Laws (UBBL, 1984) and Malaysian Standard (MS 1780)**

According to the UBBL 1984, smoke ventilation system is required in a building with no window, basement and; in a large and open space building. By Laws 249 states that; “in windowless buildings, underground structures and large area factories, smoke venting facilities shall be provided for the safe use of exit”. The Malaysian Building Code prescribes the natural smoke ventilation design is applied by installing high-level smoke vents located in roof or wall in order to exhaust smoke in case of fire. Clause 250 Sub-clause (2) of the UBBL 1984 reveals that; “*natural draught smoke vent shall utilize roof vents or vents in walls at or near the ceiling level*”. As accorded by the code, the smoke vents shall be permanent openings or if they are closed, they shall be designed to be opened automatically by opening devices. The regulation also incorporates performance requirement of the smoke ventilation system that need to be satisfied as in Clause 251; “*the smoke ventilation facilities are installed for the purposes of exit safety shall be adequate to prevent dangerous accumulation of smoke during the period of time necessary to evacuate the area served using available exit facilities with a margin of safety to allow for unforeseen contingencies*”. Where buildings with windows, smoke produced by fires may be naturally ventilated through windows’ openings.

The Uniform Buildings By-Laws (Amendment 2012) incorporates size of open structure or building in which mechanical ventilation systems are not required for the heat and smoke removal. The UBBL in tenth schedule reveals that; “*Open structure is the total area of openings is to be no less than 40% of the total perimeter wall area enclosing the floor or compartment*”. The opening(s) should be shaped and located where the total length of the openings has to be more than 50% of the perimeter of the compartment. The directions of openings are to be opened to outside of building or unenclosed space.

Additionally, the Malaysian Standard (MS:1780) states in basement buildings where the total floor area does not exceed 1000 sq. m., natural smoke ventilation by using smoke vents shall be uniformly distributed to enhance cross ventilation along perimeter of the basement and they shall be easily accessible by fire fighters. The installation can comply with the following requirements; (1) the size of vent openings is not less than 2.5% of the basement floor area, (2) the smoke vents if covered are breakable/open able from outside of the building in case of fire. On the other hand, for building above ground with floor area exceeds 1000m<sup>2</sup> or the volume exceeds 7000m<sup>3</sup>, smoke vents shall be provided at a high level above the smoke layer base. The effective vent openings shall more than



2.5% of the floor area served. The smoke vents shall be of the permanently opened type or open automatically under a fire mode condition without human intervention. Replacement air shall be by means of natural ventilation.

Similar to the UBBL 1984, the Malaysian Standard also allows the use of the window as a smoke ventilator in case of fire. The Malaysian Standard (MS: 1870) Clause 4, sub-clause 4.2, provides that; “*smoke removal in a building may be possible by natural means such as openable windows*”. Nevertheless, there are no explicit requirements incorporated by the regulations concerning on window designs and specifications for smoke ventilation in case of fire. The UBBL 1984 only prescribes design specifications of windows for the purpose of daylighting and ventilation. Clause 39, sub-clause 2 states that; “*every room used for the accommodation of patients in a hospital shall be provided with natural lighting and natural ventilation by means of one or more windows having a total area of not less than 15% of clear floor area of such room and shall have openings capable of allowing a free interrupted passage of air of not less than 10% of such floor area*”. Thus, the design of window particularly in hospital wards which is defined by the building code is not for smoke ventilation purposes when fire broke out.

#### **Australia Building Code (BCA 2010) and the Australian Standards (AS 2665)**

Part E2 of the Building Code of Australia (BCA 2010) addresses the importance of smoke management to safeguard building occupants from injury and death caused by fire products including smoke. According to Part E2.1.2.2 and 2.3, smoke management does not apply to small rooms used for short periods of time and open buildings because the smoke and hot gases can vent naturally. A small room will be quickly evacuated before smoke grows up and if the area is only used for short periods, the risk of occupants being exposed to fire is low. Part E2.3 also insists the need for careful consideration and professional judgments using fire safety engineering principles in the application of the smoke hazard management provision for special hazard buildings especially in hospital buildings. In case of natural smoke ventilation design, the building code requires only automatically-opening or permanently-open vents located in roofs complying with AS 2665 to be installed in buildings.

The Australian Standard (AS 2665) sets out the requirements for the design, installation, and commissioning of natural smoke ventilation system. The standard discusses natural smoke ventilation system by means of permanent openings or vents, smoke curtains, and inlet ventilation. The vent openings are to be installed on the roof where a reservoir of smoke can fill the area below the vents. The vents sizes are determined based on the type of fuel load within the building and must be able to withstand rain and wind conditions which may affect their effective operation. They are to be corrosive resistant and maintain the

structural adequacy as part of the roof structure. Vents are to be designed to ensure that the minimum ratios of the effective aerodynamic area to floor area are within each compartment separated by curtains or walls are met:

3:100 of areas of abnormal fire hazard

2:100 of an area other than an abnormal fire hazard

Areas of 'abnormal' fire hazards include buildings that are involved in the storage or display of goods for sale, making, assembling, altering etc of goods or a process in a laboratory and the building involves materials such as bitumen, cork, enamel, explosives and flammable liquids.

### **Britain Building Code (2000)**

According to the Approved Document B (ADB), heat and smoke venting are required in a basement. Chapter 19.2 states that "smoke outlets or smoke vents provide a route for heat and smoke to escape to the open air from the basement levels". They can also be used by the fire service to let cooler air into the basements. Sub-clause 19.4 states that "smoke outlets or smoke vents, connected directly to the open air, should be provided from every basement story that has a floor area more than 200 m<sup>2</sup> and more than 3 m below the adjacent ground level". In case of the deep basement and the amount of external wall is restricted by adjoining buildings, it is acceptable to vent smoke on the perimeter of the basement such as doors. If the basement is compartmented, each compartment should have direct access to venting. The code also does not require providing smoke ventilation system in basement equipped with external doors and windows. As stated in clause 19.6; "Where basements have external doors or windows, the compartment containing the rooms with these doors or windows do not need smoke outlets". In clause 19.7 "Natural smoke outlets should be sited at a high level, either in the ceiling or in the wall of the space they serve. They should be evenly distributed around the perimeter to discharge in the open air outside the building". 19.8 "The combined clear cross-sectional area of all smoke outlets should not be less than 1/40th of the floor area". The building code also requires the smoke outlets or smoke vents not to be placed within means of escape. The general requirements on natural smoke and heat ventilation design above do apply for hospital buildings.

### **Singapore Building Code**

The code of Buildings Designated for Conservation in Singapore serves to establish the minimum requirements for fire safety provisions. It takes into account the function, design, management, operation, and maintenance of buildings to secure the life safety of occupants in the event of fire. In relation to natural smoke ventilation, the building code prescribes the requirements in basement and other buildings including hospital buildings.

Clause 7.4.1 (a) states that smoke vents shall be adequately distributed along the perimeter of the basement and their outlets shall be easily accessible during firefighting and rescue operations. The number and their sizes shall be such that the aggregate effective vent openings shall not be less than 2.5% percent of the basement floor area served. The vent outlets if covered under normal conditions shall be openable in case of fire.

Clause 7.7.1 incorporates the provision of smoke vents having 2.5% of the floor area shall be provided to the auditorium which is not sprinkler protected and to auditorium having floor area more than 500m<sup>2</sup>, if sprinkler protected. The opening of the smoke vents shall be by automatic opening device. The natural smoke ventilation design can be done by using engineered smoke control system.

### **Comparison of smoke vent's sizes amongst countries**

The comparison of smoke vent's sizes among the four (4) countries is illustrated in Table 1. It can be deduced that the size of smoke vent for natural smoke ventilation system in building which is 2.5% of floor area is a requirement which can be found in Malaysia, Singapore and Great Britain, meanwhile for Australia is within 2-3% of floor area. It can also be noticed that Malaysia has set the requirements for the size open façade of the overall façade area through which smoke will naturally ventilated. So, it can be deduced that the size of window opening for natural smoke ventilation design in hospital building should be in the range between 2% and 3% of the buildings' floor area.

**Table 1:** Comparison of requirements for minimal size of openings for smoke ventilation among four countries

Country	Minimal percentage of smoke vent of floor area		Minimal percentage of open façade	
	Above ground building	Underground building	Above ground building	
			of total façade per floor	of floor area
Malaysia	2.5%	2.5%	40%	-
Singapore	2.5% (Auditorium)	2.5%	-	-
Australia	2-3%	-	-	-
Great Britain	2.5%	2.5%	-	5%

### **DISCUSSION AND CONCLUSION**

The paper reports on a comparative review of design requirements for natural smoke ventilation in hospital building. On the basis of the study's objectives, the following are the key findings:

- It can be concluded that there is a requirement for smoke ventilation system in windowless buildings, basement and large buildings where means of escape cannot be achieved within a short period of time. The requirement is

common to all buildings regardless of their purpose of use and occupancy. The smoke ventilation system is not required to be provided in a small room.

- In hospital building where wards are occupied by patients with limited movement, the provision of smoke ventilation design is relevant and highly important tool to meet The Required Self Egress Time (RSET). This would avoid the precedent fire cases in hospital buildings as highlighted in the literature review above.
- The provision of natural smoke ventilation would play a complimentary role to the required compartmentation in the present building regulations for hospital ward as compartmentation itself may not be sufficient to prevent smoke production and its spread to other enclosures. Therefore, natural smoke ventilation is a significant tool to be appropriately designed and provided in hospital wards in order to extent the required Available Safe Egress Time (ASET).
- The review on the natural smoke ventilation by local and other countries, found that horizontal smoke ventilation can be installed and located at high-level walls forming like vertical vents in order to exhaust smoke and heat naturally. This would cater for horizontal direction of smoke. The smoke vents (gravity vents) can either be opened position permanently or mechanically designed to open during fire if the smoke vents is closed for security reason
- Although the present building regulations in most countries allow the use of openable windows for the purpose of smoke ventilation, there is no explicitly state the requirements and specifications of the windows used for the smoke and heat ventilation. Based on the study it is obvious that the window sizes and specifications prescribed by UBBL 1984 is solely designed for natural day lighting and ventilation for general building functions. Thus, the windows as openings are in question in terms of its effectiveness to function as natural smoke ventilation.
- Furthermore, the design criteria for smoke ventilation is often specified in terms vent size. Many other design factors for natural smoke ventilation are believed not considered that may influence the performance of the system such as fire size, location and area of opening and external wind effect.
- The design (size, position and specification) of natural smoke ventilation system in a hospital building should not be generalized as applied in other buildings functions where occupied mostly by normal and able-body people.
- Fire engineering approach may be adopted to arrive at appropriate natural smoke venting design for hospital building.

In short, the present study confirms that the present building regulations do not take into account the need for natural smoke ventilation in small rooms and buildings with windows, such as hospital wards. The prescribed size and area of

windows are merely intended for emission of natural light and air ventilation but not to exhaust smoke. Therefore, appropriate and adequate design for natural smoke ventilation is pertinent for smoke control in hospital wards so that, patients and staff are protected in the event of fire.

### **ACKNOWLEDGEMENT**

The author would like to express their gratitude to Associate Professor Ar. Dr. Norwina Mohd Nawawi, Dr. Wardah Fatimah Mohammad Yusoff and Dr. Yahya Mohammad Yatim for their constructive comments on this paper.

### **REFERENCES**

- AAMA. (2010). Planning for patient safety. *Pediatrics in Review*, 847.
- Bongiovanni, I., Leo, E., Ritrovato, M., Santoro, A., & Derrico, P. (2017). Implementation of best practices for emergency response and recovery at a large hospital: A fire emergency case study. *Safety Science*, 96, 121-131.
- Chan, L. M. (2004). Scale modeling of natural vent design and the effects of vent operation time. *International Journal on Engineering Performance-Based Fire Codes*, 6(4), 272–276.
- Chen, H., Liu, N., & Chow, W. (2009). Wind effects on smoke motion and temperature of ventilation-controlled fire in a two-vent compartment. *Building and Environment*, 44(12), 2521–2526.
- Hui, M. C. (2013). An approach to provide cost effective patient fire safety. *Asia Pacific Journal of Health Management*, 8(1), 39-44.
- Jabatan Bomba dan Penyelamat Malaysia [JBPM] (2017). *Statistik kes-kes kebakaran di Malaysia 2010-2016*. Pusat Sumber Ibu Pejabat Bomba Malaysia.
- Jalali, H., Asl, E., Mehr, A., Pourafzali, S., & Ghasemi, M. (2016). Prevention and control of operating room fires: Knowledge of staff employed by selected hospitals of Isfahan University of Medical Sciences. *Digital Medicine*, 2(2), 52.
- Ji, J., Gao, Z. H., Fan, C. G., & Sun, J. H. (2013). Large Eddy Simulation of stack effect on natural smoke exhausting effect in urban road tunnel fires. *International Journal of Heat and Mass Transfer*, 66, 531–542.
- Kerber, S. (2010). *Impact of ventilation on fire behavior in legacy and contemporary residential construction*. Retrieved from <https://ulffirefightersafety.org/research-projects/impact-of-ventilation-on-fire-behavior-in-legacy-and-contemporary-residential-construction.html>.
- Kobes, M., Helsloot, I., Vries, B., & Post, J. G. (2010). Building safety and human behaviour in fire: A literature review. *Fire Safety Journal*, 45(1), 1-11.
- Krol, M. (2011). Review of smoke management in atrium. *Architecture, Civil Engineering, Environment*, 3, 121-128.
- Kulkarni, R. S., Giri, P. A., & Gangwal, P. R. (2016). Knowledge and practices regarding

- fire safety amongst health care workers in tertiary care teaching hospital in Marathwada region of Maharashtra, India. *International Journal of Community Medicine and Public Health*, 3(7), 1900-1904.
- Lai, C. M., Chen, C. J., Tsai, M. J., Tsai, M. H., & Lin, T. H. (2013). Determinations of the fire smoke layer height in a naturally ventilated room. *Fire Safety Journal*, 58, 1-14.
- Li, S., Su, C., & Tsai, K. (2016). A study on wind-induced smoke extraction systems for building fires. *MATEC Web of Conferences* 51, 02001.
- Nagral, S. (2012). Fire in a hospital. *Indian Journal of Medical Ethics*, 9(2), 77-9.
- Ong, C., & Suleiman, M. Z. (2015). Problems in implementation of fire safety management in Malaysia government hospital. *Advance of Environmental Biology*, 9(March), 47-50.
- Pal, I., & Ghosh, T. (2014). Fire incident at AMRI Hospital, Kolkata ( India ): A real time assessment for urban fire. *Journal of Business Management & Social Sciences Research*, 3(1), 9-13.
- Partridge, J. J. (2013). *Smoke hazard management in Queensland hospitals – A case study* (Master research project). University of Canterbury, Christchurch, New Zealand.
- Strating, N. (2013). *Evacuation of bedridden building occupants* (Final thesis). Eindhoven University of Technology, Eindhoven, the Netherlands.
- Su, C., Huang, H., Lin, C., & Lin, C. (2014). Numerical Simulation of The Impact of Natural Ventilation on Fire Safety in Green Buildings. *2nd Asia Conference of International Building Performance Simulation Association (ASim2014)*. Nagoya, Japan.
- Tancogne-Dejean, M., & Laclémence, P. (2016). Fire risk perception and building evacuation by vulnerable persons: Points of view of laypersons, fire victims and experts. *Fire Safety Journal*, 80, 9-19.
- Uniform Buildings By-Laws [UBBL] (1984) (Malaysia).
- Wegrzynski, W., & Krajewski, G. (2017). Influence of wind on natural smoke and heat exhaust system performance in fire conditions. *Journal of Wind Engineering and Industrial Aerodynamics*, 164, 44-53.
- Wojciech, W., & Grzegorz, K. (2017). Combined wind engineering, smoke flow and evacuation analysis for a design of a natural smoke and heat ventilation system. *Procedia Engineering*, 172, 1243-1251.
- Yatim, Y. M. (2009). *Fire safety models for high-rise residential buildings in Malaysia* (Doctoral thesis). Heriot Watt University, Edinburgh, UK.
- Yue, T. K., Chow, W. K., & Fong, N. K. (2016). Numerical simulation on the effect of natural ventilation to fire growth and the formulation of fire protection strategy for supertall buildings.



**PLANNING MALAYSIA:**

*Journal of the Malaysian Institute of Planners*

**VOLUME 16 ISSUE 2 (2018), Page 345 - 352**

## **INCLUSIVE DISASTER RISK MANAGEMENT (DRM) FOR BERTAM VALLEY COMMUNITY**

**Rahsidi Sabri Muda<sup>1</sup>, Izawati Tukiman<sup>2</sup>, Mohd Ramzi Mohd Hussain<sup>3</sup>, & Ismawi Zen<sup>4</sup>**

*<sup>1,2,3</sup>Kulliyyah of Architecture and Environmental Design,*  
INTERNATIONAL ISLAMIC UNIVERSITY MALAYSIA

<sup>4</sup>AL MADINAH INTERNATIONAL UNIVERSITY

### **Abstract**

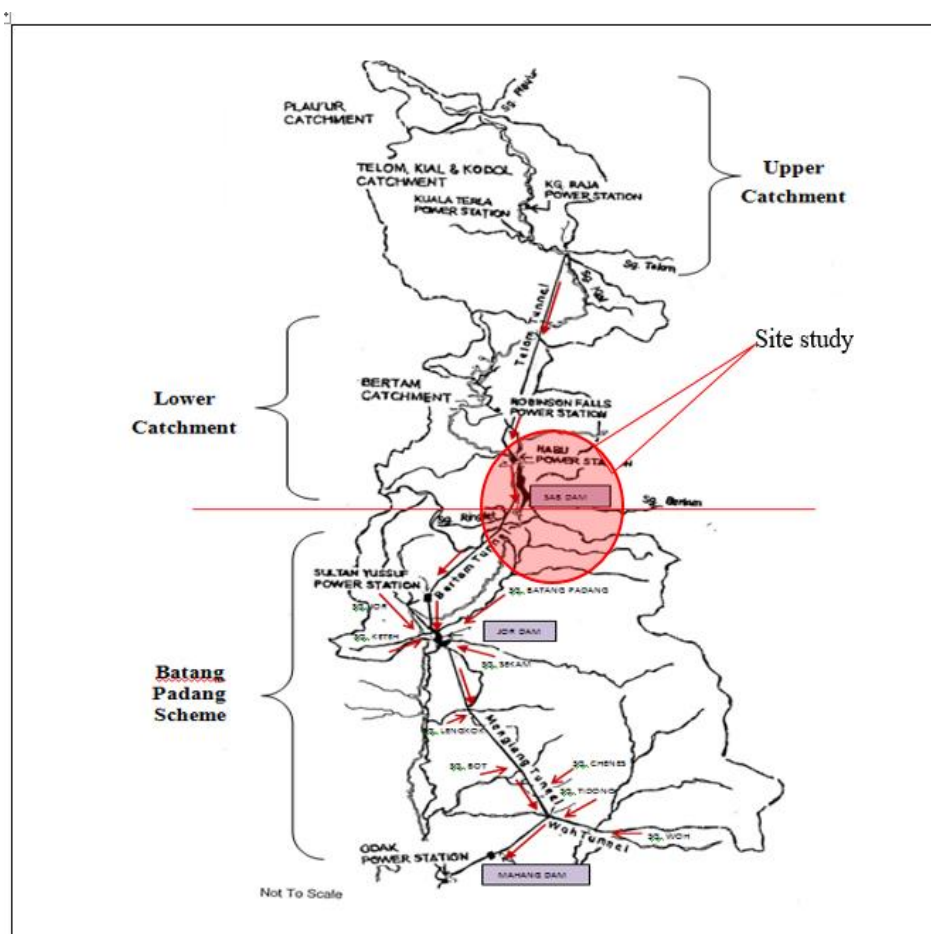
This paper focuses on the inclusiveness of Disaster Risk Management. The study assesses proactive adaptation of Early Warning System (EWS) for Disaster Risk Reduction Program in Bertam Valley. The study aims to identify community preferences as an initiative to improve the effectiveness of the EWS system. In order to sustain the awareness and preparedness of EWS, continuous involvement by the community is necessary to make them resilient. Specific focus is given to Person with Disabilities (PwDs), elderly and children. Therefore, it is vital to understand the efficient methods to alarm PwDs, elderly and children during emergencies occurrence, which will focus on the implementation of types of alarm in EWS with regards to the early warning alarm and emergency notification. The finding from this paper is useful to assist local authorities and emergency responder in the formulation of warning and evacuation procedures to save the PwDs if dam failure is imminent.

**Keyword:** disaster risk management (DRM), inclusive, early warning system (EWS), person with disabilities (PwDs), vulnerable community

<sup>2</sup>Assistant Professor at International Islamic University Malaysia. Email: izawati@iiu.edu.my

## INTRODUCTION

The community-based training and awareness program (CBTAP) is a part of the programs that was designed by the dam owner and emergency responders to educate people about the threats from the dam in Bertam Valley (Figure 1) and actions that needs to be taken. During disasters, people with personal limitation face difficulties to cope with the situation. These include people with disabilities (PwDs), older people, people who have been injured or have chronic diseases, women and children. A study by Handicap International (2015) shows that disabled people were not always aware of risk assessment phases. They were the minority of whom often left out when disaster occurred. They were left out during consultation and were neglected in the decision-making processes, hence impeding them from understanding the assessment program.



**Figure 1:** Layout plan for Cameron Highlands - Batang Padang Hydroelectric Scheme.  
 Source: TNBR, 2017



## **DISASTER RISK MANAGEMENT IN MALAYSIA**

Aggressive land opening for farming and development has increased the amount of impervious surfaces which resulted to flood during extensive storm event. It has been estimated that over 29,000 km<sup>2</sup> or 9% of the total land area of Malaysia are prone to flood affecting approximately 2.7 million people (Elgilany, Jamalludin, & Saidatulakmal, 2012). Furthermore, the population growth in developed areas has caused rapid land use changes and contributed to environmental issues. Concentration on the economy in developing countries has left the community lacking in awareness of environmental changes, especially those related to air and water. Over exploitation of natural resources have resulted in increased occurrence of environmental disaster in Malaysia (Haliza, 2014). The implications of environmental disaster have led to chronic environmental changes such as drought, soil erosion and deforestation, and as a result, problem such as flooding has worsen in the last decade and has exposed many population to disaster risk. In addition, the effects of climate change have resulted in an increasing amount of climate related disasters, resulting in a newfound threat to Malaysia's health and development. Recently, it has become a crucial challenge to Malaysia due to several holistic natural disaster events, which gave major impact on economy and finance. However, uncontrolled development activities in watersheds and along river corridors have increased the severity of floods. Cameron Highlands was one of the affected areas due to excessive land encroachment by commercial farmers (Raahsidi, Tukiman, Mohd Hussein, & Zen, 2007). Therefore, the Malaysian government has adopted UN World Conference global plan for natural disaster risk reduction, the Hyogo Frameworks for Actions (2005-2015) and Sendai Framework (2015-2030). The Sendai Framework for Disaster Risk Reduction (2015-2030) was adopted at the 3rd United Nations World Conference, which represented opportunity for countries; to focus on progressive and action for disaster risk reduction, completing the assessment and review of the implementation the 'Resilience of Nations and Communities to Disasters', strategizing and planning for disaster risk reduction through relevant regional agreements, identifying modalities of cooperation based on commitments and periodic review of the implementation of a post 2015 framework for disaster risk reduction. The official UNISDR (2009) definition of Disaster Risk Management is:

*"The systematic process of using administrative directives, organizations, and operational skills and capacities to implement strategies, policies and improved coping capacities in order to lessen the adverse impacts of hazards and the possibility of disaster."*

Therefore, Inclusive DRM (including DRR processes) is the right for those who are most at risk to benefit from and participate, as an actor, in all Disaster Risk Management policies and practices.

## **RESILIENCE CITY FOR RESILIENCE PWDS**

People with disabilities (PwDs) is among the minorities of humankind, and recent studies suggest that people with disabilities represent 10 to 12% of the world's population (Mont, 2007). Mont (2007) also highlighted that 85% of PwDs do not participated in community DRR processes.

In 2007, the World Bank issued a Guidance Note to incorporate disability criteria into its supported projects. The guidelines recommended integration on social analysis of disability in the design of thematic and sector projects and programs. Particularly regarding community driven development (CDD). The guidelines focus on inclusion of PwDs within the broader project cycle.

Disasters cause a bigger impact on those who are disabled, due to lack of access to information and services (ARUP International Development, 2012). In countries with poor structural development and scarcity of resources, the impact of natural disasters on PwDs is devastating. The loss of family members, homes, and livelihoods in the aftermath of a disaster particularly affect such individuals. Most of the temporary shelter are not equipped with proper access of supplies and proper assistance for the PwDs.

## **INCLUSIVE EARLY WARNING SYSTEM IN BERTAM VALLEY**

Early Warning System (EWS) is the provision of information to individuals, households, groups or a community about the existence of danger or hazard, and what can be done to prevent, avoid or minimize the danger. They are also to advice on the means of protection and preparedness on how to deal with the impending hazards. There are different mediums that can be used to disseminate information on EWS (Table 1).

**Table 1:** Types of disabilities and warning systems

<b>Types of disabilities</b>	<b>Warning systems</b>
Visual disabilities	<ul style="list-style-type: none"> <li>● Auditory signal system / alarms</li> <li>● Announcements</li> <li>● Posters written with large characters and colour contrast</li> </ul>
Hearing disabilities	<ul style="list-style-type: none"> <li>● Visual signal systems – red flag, symbols</li> <li>● Pictures</li> </ul>
Intellectual disabilities	<ul style="list-style-type: none"> <li>● Turn light off and on frequently</li> <li>● Special signals – red flag, symbols</li> <li>● Clear and brief announcements by rescue workers</li> </ul>
Physical disabilities	<ul style="list-style-type: none"> <li>● Auditory signal system / alarms</li> <li>● Announcements</li> </ul>

*Source: The World Bank, 2008*

Based on the World Bank (2008) key principles to inclusive disaster risk management that can be considered to suit Malaysia community, are:

- ***Non-discrimination*** - According to international law, people with disabilities must have the same opportunities to benefit from CBTAP and DRR program provided by dam owner. In UN Convention on the Rights of Persons with Disabilities requires equal access for, and prohibits discrimination against, people with disabilities in all aspects of life and establishes the obligation to ensure the protection and safety of all people with disabilities in situations of risk, including natural disasters.
- ***Accessibility***: People with disabilities should be able to enter and use facilities and gain access to the mainstreamed programs, services, and activities that are provided by dam owner. Notification of emergencies, evacuation, transportation, communication, shelter, distribution of supplies, food, first aid, medical care, housing, and application for and distribution of benefits should be accessible for people with disabilities on an equal basis with others.
- ***Involving people with disabilities and their organizations in all stages of a community driven disaster management***: People with disabilities are the most knowledgeable about their own needs and best to be referred for the inclusiveness of the whole EWS program.
- ***Appropriate early warning systems***: Disabled people can give opinion on the design of an early warning and information, education, and communication systems. The development of early warnings in a disabled-friendly may include various multi-model warning means (visual signs or signals, auditory alarms, peer support, community support, etc.), which, adapted to local conditions, and contribute to a wider dissemination and communication of risk information.

## **METHODS**

The study opted for qualitative and quantitative method. As for qualitative method, an observation was conducted during a site visit to Bertam Valley and three Orang Asli villages, which is Kg. Sg. Tiang, Kg. Mensun and Kg. Leryar. The observation recorded the various aspect of EWS that have been installed on site, such as the location, distant from one alarm to another alarm, and signages. In order to identify the obstacle that might incurred in many community-based programs, an interview has been conducted to obtain additional data, especially on the technical and operation of a EWS system and procedure during disaster. Qualitative method using questionnaire survey as its tools, which it has been designed by including the demographic data, information on community-based programs or activities and their preference of EWS.

### COMMUNITY PREFERENCE OF EWS

Table 2 shows that respondent agreed with the effectiveness of EWS in delivering the warnings through the means of siren (M = 4.70), beacon (M = 4.37), loudspeaker (M = 4.12), warning marker (M = 3.13), warning from friends or relatives (M = 4.13), and warnings from officers/authorities (M = 4.48). Flag warning, as according to the result of interview was not applied, but there were some who agreed that it would be great if flag warning could be used as an alternative method since it could really determine whether the situation was critical or not. It was apparent in this case that a functional civic organizations plays an integral role in empowering community and increases their social capacity.

**Table 2:** The effectiveness of EWS

Effectiveness of warning system	1	2	3	4	5	M	SD
Siren	.4	0	3.7	21.0	75.0	4.70	.572
Beacon	1.3	2.6	7.7	34.4	54.1	4.37	.834
Loudspeaker	3.1	4.4	12.8	36.4	43.3	4.12	1.001
Flag warning	22.5	17.2	28.0	21.4	11.0	2.81	1.301
Warning marker	12.6	15.9	30.0	28.5	13.0	3.13	1.205
TV/Radio	20.7	20.1	25.4	20.8	13.0	2.85	1.318
Electronic messages	31.6	26.3	17.2	17.6	7.3	2.43	1.292
Social networking	41.0	24.3	13.7	12.4	8.6	2.23	1.329
Warning from friends and relatives	2.6	2.2	12.1	45.7	37.5	4.13	.893
Warning from officers/authorities	.5	.5	7.5	32.9	58.5	4.48	.707
						Total	3.53 1.045

Based on community preference of EWS, the World Bank's types of disabilities and warning systems, and observation on the EWS provided by dam owner, Table 3, proved that the dam owner EWS fulfilled the alarm system to warn PwDs in the event of dam failure in Lembah Bertam and its vicinity. However, continuous staff training for additional skills and assistance would strengthen, sustain and improve the overall EWS.

**Table 3:** Inclusiveness of EWS provided by dam owner

Types of disabilities	Consideration of EWS (The World Bank, 2008)	Community preference of EWS	Skills and assistance
Visual disabilities	Auditory signal system / alarms	Siren	
	Announcements	Instruction by community leader (Tok Batin, JKKK) and	

		responsible authorities (JPA, police, etc.)	
	Posters written with large characters and colours contrast	Signages	Leaflet with Braille to explain further information of 'disaster shelter program'
Hearing disabilities	Visual signal systems – red flag, symbols	Beacons (flash lights)	
	Pictures	Signages	
		Responsible person in charged	Ability to communicate in basic sign language.
Intellectual disabilities	Turn light off and on frequently	Siren and beacons	
	Clear and brief announcements by rescue workers	Instruction by community leader (Tok Batin, JKKK) and responsible authorities (JPA, police, etc.)	
	Special signals – red flag, symbols	Signages with symbols	Symbols to be introduce to PwDs
Physical disabilities	Auditory signal system / alarms	Siren and beacons	
	Announcements	Instruction by community leader (Tok Batin, JKKK) and responsible authorities (JPA, police, etc.)	

## CONCLUSION

The dam owner has taken into consideration of inclusiveness in the design of its EWS program as a whole. This is to support Malaysia commitment to the 'Sendai Framework' for Disaster Risk Reduction, which a continuous support from 'Hyogo Framework' for Action. The CBTAP program also met the UN Convention on the Rights of Persons with Disabilities (CRPD), Articles 11 and 32 require that persons with disabilities benefit from and participate in disaster relief, emergency response and Disaster Risk Reduction strategies. Dam owner had put their initiative by providing training for stakeholder and agencies that involved during dam failure. In addition, information was also disseminated to

community through various programs such as educational activities in schools within the affected areas. The inclusiveness of CBDRM program will be continuously improved by involving respected PwDs associations in the future to provide specialist inputs.

#### **ACKNOWLEDGEMENT**

The authors would like to thank the Tenaga Nasional Research Sendirian Berhad (TNBR) for their kind support by giving useful information and advice on conducting the research. This paper was a result from research grant collaboration between IIUM-UNITEN and TNBR.

#### **REFERENCES**

- ARUP International Development (2012). *Characteristic of a safe and resilient community: Community based disaster risk reduction study*. Retrieved from [http://www.ifrc.org/PageFiles/96986/Final\\_Characteristics\\_Report.pdf](http://www.ifrc.org/PageFiles/96986/Final_Characteristics_Report.pdf).
- Elgilany, A., Jamalludin S., & Saidatulakmal M. (2012). Importance of floods management in Malaysia. *International Conference on Environmental Research and Technology (ICERT) 2012*. Penang, Malaysia.
- Haliza, A. R. (2014). An overview of environmental disaster in Malaysia and preparedness strategist. *Iranian Journal of Public Health*, 43(3), 17-24.
- Handicap International (2015). Inclusive disaster risk reduction post 2015: Handicap International expertise. Retrieved from [http://www.handicap-international.ch/sites/ch/files/documents/files/inclusive\\_disaster\\_risk\\_reduction\\_post201\\_hi\\_expertise.pdf](http://www.handicap-international.ch/sites/ch/files/documents/files/inclusive_disaster_risk_reduction_post201_hi_expertise.pdf)
- Mont, D. (2007). *Measuring disability prevalence*. Washington DC: The World Bank.
- Rahsidi, S. M., Tukiman, I., Mohd Hussein, M. R., & Zen, I. (2017, October). Perception analysis on public awareness and preparedness towards Early Warning System (EWS) for dam safety: A case study in Bertam Valley Cameron Highlands. *HYDRO2017 Conference*. October 8-11, 2017, Seville, Spain.
- The World Bank (2008). *Building the resilient communities*. Retrieved from [http://siteresources.worldbank.org/INTSF/Resources/Building\\_Resilient\\_Communities\\_Complete.pdf](http://siteresources.worldbank.org/INTSF/Resources/Building_Resilient_Communities_Complete.pdf).
- UNISDR. (2009). Terminology on disaster risk reduction. *International Strategy for Disaster Reduction (ISDR)*, 35.

## **NOTES TO CONTRIBUTORS AND GUIDELINES FOR MANUSCRIPT SUBMISSION**

### **INTRODUCTION**

The Journal of the Malaysian Institute of Planners or PLANNING MALAYSIA is a multidisciplinary journal related to theory, experiments, research, development, applications of ICT, and practice of planning and development in Malaysia and elsewhere.

The objective of the journal is to promote the activity of town planning through dialogue and exchange of views concerning professional town planning practice. PLANNING MALAYSIA will welcome any news, feature articles, or peer reviewed (including book reviews, software review, etc.) articles for publication. All articles should be original work by the authors. **Articles, views and features will not be taken to be the official view of the Malaysian Institute of Planners (MIP) unless it carries the name of MIP as the author.** This is to encourage open discussion on diverse issues and opinion for the advancement of town planning practice. Articles and contributions will be accepted from MIP members and non-members worldwide.

In year 2010, PLANNING MALAYSIA Journal has been indexed in SCOPUS. Previous issues of PLANNING MALAYSIA Journal can be viewed on the MIP website.

### **SUBMISSION OF MANUSCRIPTS**

Manuscript should be emailed to pmjournal@gmail.com. Manuscript should ideally be in the range of 8-10 pages long. Each manuscript should have a title page and an abstract of about 150 words. The title page should contain the title, full name(s), designation(s), organizational affiliation(s), a contact address, and an email address. All manuscripts are received on the understanding that they are not under concurrent consideration at another journal. Exclusive copyright of accepted manuscripts shall be assigned to the Publisher (i.e. the MIP), and in consideration for this, one copy of the current Journal will be provided for each article. Additional reprints of article can be ordered, at cost, by the author(s). PDF format of the article (if available) can be obtained from the Publisher.

### **LAYOUT**

Manuscript should be typed in single spacing (including footnotes, endnotes and references) on one side of the paper only (preferably A4) with the following margins: right and left - 4.25 cm, top - 5.5 cm and bottom - 5.2 cm (including header – 4.5 cm and footer – 4.3 cm) in 11 point Times New Roman font. Footnotes should be numbered consecutively and placed at the end of the manuscript. Footnotes should be kept to a minimum. Tables and diagrams should be provided in the text. References should follow the APA (6th Edition) referencing format. All foreign words must be typed and transliterated. The Editorial Board reserves the right to change the transliteration of all historical names, titles and non-English terminology to bring them into conformity with its own style.

## USE OF FORMULA, FIGURES AND TABLES

Formula (mathematical formula) should be used only when necessary and the CONCLUSION derived must be explained and made intelligible to a non-mathematical reader. Wherever possible, authors are encouraged to place the mathematical parts of the article in an appendix. In cases of empirical articles, authors are expected to make readily available a complete set of data and any specialized computer programs to interested readers.

All illustrations, figures and/or tables in the manuscript must be captioned, in clear black and white (grayscale) and ready for reproduction.

## REFEREEING PROCEDURE

Manuscripts will be acknowledged upon receipt. Only selected (preferred) manuscripts will be **reviewed by two (or three) referees** in addition to the editors. Editorial decision will normally be made within **two to six months**, but circumstances beyond control occasionally dictate a longer cycle. If authors are invited to prepare a revision for further consideration, the major issues to be resolved will be outlined and will be forwarded to them as quickly as possible.

## ACCEPTED ARTICLES

Authors of accepted articles will be requested to provide a digital copy of the manuscript, preferably in Microsoft Word to the MIP (the Publisher) via email at pmjournal@gmail.com. MIP will not be responsible for the loss or damage of the digital copy.

## COPYRIGHT

Copyright & Creative Commons Licence  
eISSN: 0128-0945 © Year. The Authors. Published for Malaysia insitute of planner.  
This is an open-access article under the [CC BY-NC-ND](#) license.

The authors hold the copyright without restrictions and also retain publishing rights without restrictions.

### Contact:

*Editor-in-Chief*  
**PLANNING MALAYSIA**  
Journal of the Malaysian Institute of Planners  
B-01-02, Jalan SS7/13B, Aman Seri, Kelana Jaya,  
47301, Petaling Jaya, Selangor Darul Ehsan, MALAYSIA  
Tel: +603 78770637 Fax: +603 78779636  
Email: [pmjournal@gmail.com](mailto:pmjournal@gmail.com)  
Homepage: [www.planningmalaysia.org](http://www.planningmalaysia.org)

\*\*\*



## **ETHIC STATEMENT**

The Journal of the Malaysia Institute of Planners or **PLANNING MALAYSIA** is a peer-reviewed journal. This statement spells out ethical behaviour of all parties involved in the act of publishing an article for this journal, i.e. the author, the peer-reviewer, the chief editor and editors, and the publisher. This statement is based on COPE's Best Practice Guidelines for Journal Editors. URL: [http://publicationethics.org/files/u2/Best\\_Practice.pdf](http://publicationethics.org/files/u2/Best_Practice.pdf)

### **DUTIES OF AUTHORS**

#### **Reporting Standards**

Authors of original research should present an accurate account of the work done as well as an objective discussion of its significance. Data of the research should be represented accurately in the article. An article should contain sufficient detail and references to permit others to replicate the work. Fraudulent or knowingly inaccurate statements constitute unethical behaviour and are unacceptable.

#### **Data Access and Retention**

Authors may be asked to provide the raw data in connection with an article submitted for editorial review, and should be prepared to provide public access to such, if practicable, and should in any event be prepared to retain such data for a reasonable time after publication.

#### **Originality and Plagiarism**

Authors should ensure that they have written entirely original works, and if the authors have used the work and/or words of others this must be appropriately cited or quoted. Such quotations and citations must be listed in the Reference at the end of the article.

#### **Multiple Publication**

An author should not in general publish manuscripts describing essentially the same research in more than one journal or primary publication. Submitting the same manuscript to more than one journal concurrently constitutes unethical publishing behaviour and is unacceptable.

#### **Acknowledgment of Sources**

Proper acknowledgment of the work of others must always be given. Authors should cite publications that have been influential in determining the nature of the reported work.

#### **Authorship of the Paper**

Authorship should be limited to those who have made a significant contribution to the conception, design, execution, or interpretation of the study, and should be listed as co-authors. Others who have participated in certain substantive aspects of the research project, they should be acknowledged or listed as contributors.

### **Corresponding Author**

Corresponding author is the author responsible for communicating with the journal for publication. The corresponding author should ensure that all appropriate co-authors and no inappropriate co-authors are included on the paper. All co-authors have seen and approved the final version of the paper and have agreed to its submission for publication.

### **Acknowledgment of Funding Sources**

Sources of funding for the research reported in the article should be duly acknowledged at the end of the article.

### **Disclosure and Conflicts of Interest**

All authors should disclose in their manuscript any financial or other substantive conflict of interest that might be construed to influence the results or interpretation of their manuscript.

### **Fundamental Errors in Published Works**

When an author discovers a significant error or inaccuracy in his/her own published work, it is the author's obligation to promptly notify the journal editor or publisher and cooperate with the editor to retract or correct the paper.

## **DUTIES OF REVIEWERS**

### **Contribution of Peer Review**

Peer review assists the chief editor and the editorial board in making editorial decisions while editorial communications with the author may also assist the author in improving the paper.

### **Unqualified to Review or Promptness**

Any reviewer who feels unqualified to review the assigned manuscript or unable to provide a prompt review should notify the editor and excuse himself/herself from the review process.

### **Confidentiality**

Manuscripts received for review must be treated as confidential documents. They must not be shown to, or discussed with, others except as authorized by the chief editor. Privileged information or ideas obtained through peer review must be kept confidential and not used for personal advantage.

### **Standards of Objectivity**

Reviews should be conducted objectively. There shall be no personal criticism of the author. Reviewers should express their views clearly with supporting arguments.

### **Acknowledgment of Sources**

Reviewers should identify relevant published work that has not been cited by the authors. Any statement that had been previously reported elsewhere should be accompanied by the relevant citation. A reviewer should also call to the chief editor's attention any

substantial similarity or overlap between the manuscript under consideration and any other published paper of which they have personal knowledge.

**Conflict of Interest**

Reviewers should decline to review manuscripts in which they have conflicts of interest resulting from competitive, collaborative, or other relationships or connections with any of the authors.

**DUTIES OF EDITORS**

**Decision on the Publication of Articles**

The chief editor of the PLANNING MALAYSIA is responsible for deciding which of the articles submitted to the journal should be published. The chief editor may be guided by the policies of the journal's editorial board subjected to such legal requirements regarding libel, copyright infringement and plagiarism. The chief editor may confer with other editors or reviewers in making this decision.

**Fair play**

Manuscripts shall be evaluated solely on their intellectual merit.

**Confidentiality**

The chief editor/editors and any editorial staff must not disclose any information about a submitted manuscript to anyone other than the corresponding author, reviewers, potential reviewers, other editorial advisers, and the publisher.

**Disclosure and Conflicts of Interest**

Unpublished materials disclosed in a submitted manuscript must not be used by anyone who has a view of the manuscript while handling it in his or her own research without the express written consent of the author

## PLANNING MALAYSIA JOURNAL: THE PAST ISSUES

### **Volume 1, 2003: (<http://www.mip.org.my/doc/journal1.pdf>)**

1. Incorporating Sustainable Development Objectives into Development Plans through Strategic Environmental Assessment  
*Muhammad Faris Abdullah & Ishak Ariffin*
2. Environmental Concern in Local Planning Practice  
*Foziah Johar*
3. Ecotourism Planning: Who is Really Responsible?  
*Badarudin Mohammed & Abdul Aziz Hussin*
4. Towards A Sustainable Built Environment: Environmentally Conscious Planning, Design and Construction  
*Norhayati Mahyuddin*
5. Rural Sustainability: An Examination of the Practice of Sustainable Development Principles in A Rural Community in Malaysia  
*Ibrahim Ngah*
6. Managing Urban Development Process by Using Spatial Information System: A Case Study of I-Space  
*Alias Abdullah, Muhammad Faris Abdullah & Fauzan Nordin*
7. USM Pushing the Frontier of Town Planning  
*Lee Lik Meng*
8. The Suburbanisation of the Kuala Lumpur Metropolitan Region  
*Jamalunlaili Abdullah*

### **Volume 2, 2004: (<http://www.mip.org.my/doc/vol.2-2004.pdf>)**

1. Creating The Essence of Cities: The Putrajaya's Experience  
*Jebasingam Issace John*
2. A Study to Evaluate Child-Friendly Neighbourhoods through a Set of Child-Friendly Indicators  
*Alias Abdullah & Nik Munerahanim Nik Muhammad*
3. The Evaluation of Beaches in Northern Malaysia  
*Badarudin Mohammed, Rahmat Azam Mustafa, Adrin Abdullah, A. Ghafar Ahmad & Shida Irwana Omar*
4. Urban Land Use Change & the Langat Basin Ecosystem Health  
*Shaharudin Idrus & Abdul Samad Hadi*
5. Application of Land Use Approaches in Controlling Industrial Wastewater Discharge into River  
*Muhammad Faris Abdullah*

### **Volume 3, 2005: (<http://www.mip.org.my/doc/vol.3-2005.pdf>)**

1. Planning Education, Accreditation & Inter-Professional Links  
*Mohd Talha Alithamby*
2. Electronic Local Authority Management System  
*Tan Thean Siew*
3. A Study on the Demand of Spatial Planning & Decision Support System in Malaysia  
*Muhammad Faris Abdullah, Alias Abdullah, Mansor Ibrahim & Dazilah Abdul Samad*
4. The Technology of Asset Management & Maintenance Culture in Ensuring Sustainable Development  
*Khairiah Talha & KC Leong*
5. Tessellation Planning & Honeycomb Housing

*Mazlin Ghazali, Michael J. Durack & Mohd Peter Davis*

6. The Application of the Concept of Defensible Space for Secured Housing Environment  
*Saari Omar & Megat Arif Shah Megat Omar*

**Volume 4, 2006: (<http://www.mip.org.my/doc/vol.4-2006.pdf>)**

1. How We Failed to Plan for Habitability  
*Lee Lik Meng, Aldrin Abdullah, Tan Sook Fern, Nurwati Badruzaman & Ahmad Sanusi Hassan*
2. Cairo's Al-Azhar Park: Millennium Development Goals Etched in Green  
*Khaled el-Khishin*
3. Knowledge Cities: Examining the Discourse Smart Villages, Internet Cities or Creativity Engines  
*Ali A. Alrouf*
4. A Preliminary Investigation of a Model On the Decision to Implement Teleworking in The Japanese Business Organisations  
*Abdul Azeez Kadar Hamsa & Masao Miura*
5. An Integration of Multicriteria Analysis with GIS in the Malaysian National Physical Plan  
*Nor Sallehi Kassim & Rafikul Islam*

**Volume 5, 2007: (<http://www.mip.org.my/doc/vol.5-2007.pdf>)**

1. Effectiveness of Public Participation Programme: A Feedback from Participants (Sabak Bernam District Local Plan and Kuala Lumpur Structure Plan)  
*Dasimah Omar & Oliver Ling Hoon Leh*
2. Multicriteria Analysis of Flood Causes in Kuala Lumpur  
*Nur Fazzillah Muhamed Noordin, Alias Abdullah & Muhammad Nur Azraei Shahbudin*
3. Urban Housing Development: Town Planning Issues  
*Ibrahim Mohd @ Ahmad, Ezrin Arbi & Ahmad Ramly*
4. Sustainable City Planning: Emphasis on the Management of Environmentally Sensitive Areas  
*Halimaton Saadiah Hashim, Joy Jacqueline Pereira & Ibrahim Komoo*
5. The Environment Component in Sustainability Assessment at the Local Level Plan  
*Abdul Hadi Harman Shah, Shaharudin Idrus & Abdul Samad Hadi*
6. Developing a Communicative Planning Approach to Resolve Land Use Conflicts in Jelutong Area of Georgetown, Penang, Malaysia  
*Mohammad Abdul Mohit & Raja Mohd. Firdous B. R.M. Harun*
7. Komuniti Mapan: Penilaian Tahap Kemapanan Komuniti Orang Asli Temiar Di Negeri Perak  
*Khairul Hisyam B. Kamarudin & Ibrahim B. Ngah*
8. Book Review: "The Boulevard Book"  
*Shu Charng Yen*

**Volume 6, 2008: (<http://www.mip.org.my/doc/vol.6-2008.pdf>)**

1. Safe City Programme: Are we on the right path to reduce crime?  
*Kamalruddin bin Shamsudin*
2. The Contribution of *Fiqh al-Jinayat* (Islamic Criminal Law) To the Planning of a Safe City  
*Azila Ahmad Sarkawi, Ahmad Basri Ibrahim & Alias Abdullah*
3. Urban Crime and Safe Neighbourhood: Community Perspectives  
*Khairiah Talha*
4. Towards A Safe Place for Children in Today's Residential Neighbourhoods  
*Halimaton Saadiah Hashim, Joy Jacqueline Pereira & Ibrahim Komoo*
5. Role of Land Use Planning in Improving Public Health: Way Forward for Malaysia

*Ainul Jaria Maidin*

6. Energy Consumption and Carbon Dioxide Emission Considerations in The Urban Planning Process in Malaysia  
*Wee Kean Fong, Hiroshi Matsumoto, Chin Siong Ho & Yu Fat Lun*

**Volume 7, 2009: (<http://www.mip.org.my/doc/journal7.pdf>)**

1. Urbanization, Environmental Planning and Management: A Challenge for Jamaica.  
*Leiska J. Powell*
2. Structural Changes of the Malaysian Economy and Its Spatial Incidence on Regional Economic Growth  
*Mohammad Abdul Mohit*
3. Urban Sustainability and Growth Management in South-East Asian City-Regions: The case of Kuala Lumpur and Hong Kong  
*Suharto Teriman, Tan Yigitcanlar, Severine Mayere*
4. Urban Sprawl in Malaysia: Evidences from Three Largest Metropolitan Areas  
*Jamalunlaili, Mohd. Zulhafidz Yahaya, Mohd Zuwairi Mod Yunus & Mohd Shakir Md Ali Safudin*
5. An Integrated Approach for the Prediction of Water Quality Index Based on Land Use Attributes Using Data Generation Method and Back Propagation Network Algorithm  
*Faris Gorashi & Alias Abdullah*
6. Groundwater Extraction Modeling for Kuala Lumpur Water Resource Planning  
*Pieter E. Stek*
7. Power of the Local Authority in Regulating Land Planning and Development Control: Whither Control  
*Ainul Jaria Maidin & Bashiran Begum Mobarak Ali*
8. Australia Planning Report Card – Telling It Like It Is!  
*Liz de Chasterl*

**Volume 8, 2010: (<http://www.mip.org.my/doc/vol.8-2010.pdf>)**

1. Vehicle Ownership and Quality of Life in Urban Residential Neighbourhoods, Northern Peninsular Malaysia  
*Abdul Ghapar Othman & Hassim Mat*
2. Analysis of Commute Characteristics and Residential Location Choice of IIUM Gombak Campus Employees of Malaysia  
*Mohammad Abdul Mohit & Mootaz Munjid Mustafa*
3. The Relationship between Urban Population Density and Transportation Fuel Consumption in Malaysian Cities  
*Neoh Siew Yin & Ho Chin Siong*
4. The Socio-technical Factors in the Use of GIS at the Planning Departments of the Kuala Lumpur City Hall  
*Mohd Ramzi Mohd Hussain*
5. Book Review: Handbook of Research on E-Planning: ICTs for Urban Development and Monitoring, Carlos Nunes Silva (Eds.) IGI Global Publishing Company, Hershey, Pennsylvania, USA (2010). 454 pages. ISBN-13:9781615209293.  
*Alias Abdullah & Carlos Nunes Silva*

**Volume 9, 2011: (<http://www.mip.org.my/doc/vol9.pdf>)**

1. City Development Strategies (CDS) Contribution toward Sustainable Urban Development in Developing Countries  
*S. Mostafa Rasoolimanesh, Nurwati Badarulzaman & Mastura Jaafar*
2. Urban Residents' Attitude toward Wildlife in Their Neighbourhoods: The Case Study of Klang Valley, Malaysia

*Nik Hanita Nik Mohamad*

3. Evaluating Stakeholders' Preferences: Reconciling Heritage and Sustainability in Kuala Lumpur Traditional Area  
*Noor Amila Wan Abdullah Zawawi & Alias Abdullah*
4. Solid Waste Generation Characteristics: The Malaysia Local Authorities' Outlook  
*Muhammad Abu Eusuf, Mansor Ibrahim, Shamzani Affendy Mohd. Din & Rafikul Islam*
5. Urban Air Environmental Health Indicators: A Preliminary Set for City of Kuala Lumpur  
*Oliver Ling Hoon Leh, Shaharuddin Ahmad Kadaruddin Aiyub & Yaakob Mohd. Jani*
6. Classification of Satellite Fused Data for Land Use Mapping in Development Plan  
*Norzailawati Mohd Noor, Alias Abdullah & Mazlan Hashim*

**Special Issue I, 2011:**

**(<http://www.mip.org.my/doc/MIP%20Jurnal%20Special%20Issue%20on%20Langkawi.pdf>)**

1. Conservation with Development: Showcasing Langkawi Geopark - An Introduction  
*Halimaton Saadiah Hashim & Rahimah Abdul Aziz*
2. Geopark for Heritage Conservation: A Need for Integrated Planning and Management  
*Rahimah Abdul Aziz, Halimaton Saadiah Hashim, & Ibrahim Komoo*
3. Implementing Langkawi Geopark through Land Use Planning  
*Noor Yazan Zainol, Hapiz Abd Manap, Ibrahim Jacob, Mahani Muhammad, Mariam Tajuddin & Ikhwan Mohd Said*
4. The Importance of Geological Heritage Resources in Land Use Planning: Experience from Langkawi Geopark  
*Che Aziz Ali & Tanot Unjah*
5. Land Use Planning Statutes for Langkawi Geopark Conservation and Development  
*Sarah Aziz, Halimaton Saadiah Hashim, Rahimah Abdul Aziz, Chan K. L. Geraldine & Tanot Unjah*
6. Potential Biosites of Significant Importance in Langkawi Geopark: Terrestrial Vertebrate Fauna  
*Norhayati, A., Chan, K.O., Daicus, B., Samat, A., Grismer, L.L., & Mohd Izzuddin, A.*
7. Planning for Heritage Tourism: The Case of Langkawi Geopark  
*Ong Puay Liu & Sharina Abd Halim*
8. Place Making, Place Names, and Local Myths and Legends  
*Rahimah Abdul Aziz & Ong Puay Liu*
9. Introducing Networks in Planning: An Example from Langkawi  
*Chan K. L. Geraldine, Halimaton Saadiah Hashim & Sarah Aziz*
10. Participation towards Heritage Conservation: Case of a Fishing Community in Langkawi Geopark  
*Sharina Abdul Halim, Ong Puay Liu, Nurhafizah Yussof & Lim Choun Sian*

**Volume 10, 2012: (<http://www.mip.org.my/doc/vol.10-2012.pdf>)**

1. Determinant Factors of Neighbourhood Quality  
*Norainah Abdul Rahman, Dasimah Omar & Abdul Ghani Salleh*
2. The Relationship between Variations of Grid Layout and Burglary  
*Saniah Ahmad Zaki & Jamalunlaili Abdullah*
3. Analysis of Factors Influencing the Stated Preference of Academic Employees towards Telecommuting in IIUM Campus, Gombak  
*Farah Diyanah Ismail, Abdul Azeez Kadar Hamsa & Mansor Ibrahim*
4. Study on the Potential of Urban Forest Park for Sustainable City  
*Noralizawati Mohamed, Noriah Othman & Mohd Hisham Ariffin*

5. A Study on the Effectiveness of Provision of New Static Information Signage: A Case Study of International Islamic University Malaysia, Gombak Campus  
*Syazwani Sahrir, Syahriah Bachok & Mariana Mohd. Osman*
6. Study the Construction and Demolition Wastes in Klang Valley, Malaysia  
*Muhammad Abu Eusuf, Mansor Ibrahim & Rafikul Islam*
7. The Future of Coastal Management Programme in Malaysia: Making the Coast Visible to Planners  
*M. Zainora Asmawi*

**Special Issue II, 2013: (<http://www.mip.org.my/doc/se2013.pdf>)**

1. Impacts of Urban Land Use on Crime Patterns through GIS Application  
*Ahmad Nazri Muhamad Ludin, Norsiah Abd. Aziz, Nooraini Hj Yusoff & Wan Juliyana Wan Abd Razak*
2. Estimation of Residential Impervious Surface using GIS Technique  
*M. Rafee Majid, Jamal Aimi Jamaludin & Wan Yusryzal Wan Ibrahim*
3. Green Space Audits on its Accessibility in Pasir Gudang  
*Wan Yusryzal Wan Ibrahim, Ahmad Long & Ariva Sugandi Permana*
4. Firm Dynamic Analysis for Urban Land Use and Economic Growth Modelling  
*Noordini Che' Man, Soheil Sabri, Nafisa Hosni & Harry Timmermans*
5. Assessment of Neighbourhood Affordability based on Housing and Transportation Costs in Kuala Lumpur, Malaysia  
*Soheil Sabri, Ahmad Nazri M. Ludin & Foziah Johar*
6. Potential Urban Development Parameters that Reduce Energy Consumption in Residential Area  
*Ariva Sugandi Permana, Norsiah Abd. Aziz & Abd. Razak Jaffar*
7. Incorporating Pedestrian Index into Googlemaps  
*Nabila Abdul Ghani, Muhammad Zaly Shah Muhammad Hussein & Safizahanin Mokhtar*
8. Seismic Microzonation for Banda Aceh City Planning  
*Foziah Johar, M. Rafee Majid, Abdul Razak Jaffar & Adi Safyan Yahya*
9. The Reliability Test of Visual Landscape Features Measurement in Highlands Tourism Planning  
*Nafisa Hosni, Nooraini Yusoff & Hairul Nizam Ismail*

**Volume 11, 2013: (<http://www.mip.org.my/doc/Journal%202014.pdf>)**

1. Malaysian Development Plan System: Issues and Problems, One Decade after its Reform (2001-2011)  
*Faizah Ahmad, Ibrahim Mohd., Syra Lawrance Maidin, Rosilawati Zainol & Norzailawati Mohd Noor*
2. Perceptions on Quality of Life in Malaysia: The Urban-Rural Divide  
*Norhaslina Hassan, Noor Ismawati Mohd Jaafar, Raja Noriza Raja Ariffin, Asnarulkhadi Abu Samah & Mohd Nazari Jaafar*
3. Awareness by Kuala Lumpur City Hall Staffs for Successful Implementation of Crime Prevention through Environmental Design (CPTED)  
*Shuhana Shamsuddin & Natasha Azim Hussin*
4. Sustainable Forest Management in Lower Kinabatangan, Sabah: Issues and Current Practices  
*Normah Abdul Latip, Nurwati Badarulzaman, Azizan Marzuki & Mohd Umzarulazijo Umar*
5. User's Preference and Perception on the Pedestrian Crossing in Malaysia: The Case of Ampang Road, Kuala Lumpur  
*Oliver Ling Hoon Leh, Zamila Zamri, Mohd Zamreen Mohd Amin & Marlyana Azyyati Marzukhi*



6. Commuters' Perceptions on Rail based Public Transport Services: A Case Study of KTM Komuter in Kuala Lumpur City, Malaysia  
*Syahriah Bachok, Mariana Mohamed Osman, Ummi Aqilah Khalid & Mansor Ibrahim*
7. Land Cover Change Detection Analysis on Urban Green Area Loss Using GIS and Remote Sensing Techniques  
*Norzailawati Mohd Noor, Alias Abdullah & Mohd Nasrul Hanis Manzahari*
8. Analysis of Factors Influencing Use of Motorcars in International Islamic University Malaysia  
*Nelza Lynna Abdul Rahim & Abdul Azeez Kadar Hamsa*

**Volume 12, 2014: <http://www.mip.org.my/doc/Journal12.pdf>**

1. Evaluating the Impact of Density on Access to Local Facilities in Urban Neighbourhoods  
*Wan Nurul Mardiah Wan Mohd Rani*
2. Town Planners' Perceptions of Sports Facilities and Urban Development: A Case Study of 13 States' Main Sports Facilities in Malaysia  
*Maassoumeh Barghchi & Dasimah Bt Omar*
3. Disaster Risk Reduction in Malaysian Urban Planning  
*Intan Afida Mohamad Amin & Halimaton Saadiah Hashim*
4. Conceptualise Tourism Support System through Web-Based GIS for Collaborative Tourism Planning  
*Tarmiji Masron, Azizan Marzuki, Badaruddin Mohamed & Norizawati Mohd Ayob*
5. Integrating Climate Change Mitigation and Adaptation into Spatial Planning: Developing Criteria for Spatial Plan Evaluation in the Selangor River Basin  
*Chee Ping Ngang, Joy Jacqueline Pereira & Halimaton Saadiah Hashim*
6. Analysis on Community Involvement in Cultural Activities: Transmission of Ethnic Language  
*Aisyah Abu Bakar, Mariana Mohamed Osman, Syahriah Bachok & Mansor Ibrahim*

**Special Issue III, 2014: (<http://www.mip.org.my/doc/JournalSE3.pdf>)**

1. Geospatial Technology Approaches in Urban Morphology for Resilient Urban Governance  
*Norzailawati binti Mohd Noor, Marina Mohd Nor, Alias Abdullah & Rustam Khairi Zahari*
2. Sustainable Governance in relation to the Financial Aspect in Managing Coastal Areas: Malaysian Experience  
*M.Zainora Asmawi, Lukman Hakim Mahamod, Mohd Zin Mohamed & Tuminah Paiman*
3. E-payment at the Local Government Level: A Study of Majlis Bandaraya Shah Alam and Majlis Daerah Kampar  
*Rustam Khairi Zahari, Raja Noriza Raja Ariffin, Nurhawani Zamin & Norzailawati binti Mohd Noor*
4. Residential Satisfaction –Concept, Theories & Empirical Studies  
*Mohammad Abdul Mohit & Adel Mahfoud Mubarak Al-Khanbashi*
5. Historical Influences to Present Legal Setting of Planning Law in Malaysia  
*Azila Ahmad Sarkawi & Muhammad Faris Abdullah*
6. Understanding of Tourists' Preferences Pattern: A Study in Melaka, Malaysia  
*Syakir Amir, Mariana Mohamed Osman, Syahriah Bachok & Mansor Ibrahim*
7. The Review for the Use of Urban Climatic Map in the Land Use Plan for Urban Planning  
*Illyani Ibrahim, Azizan Abu Samah & Rosmadi Fauzi*
8. Evaluating the Effects of Road Geometrical Design Towards Spot Speed Distribution on Arterial Road  
*Noor Hafiza Mohd Maksid & Abdul Azeez Kadar Hamsa*

**Volume 13, 2015: (<http://www.mip.org.my/doc/PMJ2015.pdf>)**

1. Creative Cities Research in Penang, Malaysia: A Review of Conceptual and Methodological Framework  
*Khoo Suet Leng, Nurwati Badarulzaman, Narimah Samat, Morshidi Sirat & Sharifah Rohayah Sheikh Dawood*
2. The Role of Fabric Banners for Community Engagement in Digital Era  
*Rosilawati Zainol, Goh Hong Ching, Ibrahim Mohd, Nikmatul Adha Nordin, Siti Maisara Baharom & Tengku Adeline Adura Tengku Hamzah*
3. Thermal Comfort and Energy Solutions for a Better Residential Environment in Malaysia  
*Noor Aziah Mohd Ariffin*
4. The Relationship of Human Happiness and Neighbourhood Planning: Case Study Puchong Indah Housing Estate, Selangor, Malaysia  
*Oliver Ling Hoon Leh, Farah Ayuni Marhalim, Siti Nur Afiqah Mohamed Musthafa, Yusfida Ayu Abdullah & Marlyana Azyyati Marzukhi*
5. Assessing the Urban and Rural Stage Bus Services Disparities in Peninsula Malaysia  
*Zakiah Ponrahono, Syahriah Bachok, Mariana Mohamed Osman, Mansor Ibrahim, Muhammad Faris Abdullah & Alias Abdullah*
6. The Roles of Urban Heritage in Determining the Image of the Royal Town of Sri Menanti, Negeri Sembilan  
*Nor Zalina Harun, Dg. Norhidayah Fairuz & Nor Adilla Nordin*
7. Carbon Sequestration through Urban Green Reserve and Open Space  
*Alamah Misni, Sakurah Jamaluddin & Siti Mazwin Kamaruddin*
8. Sustainable Governance in Relation to the Financial Aspect in Managing Coastal Areas: Malaysian Experience  
*M.Zainora Asmawi, Lukman Hakim Mahamod, Mohd Zin Mohamed, & Tuminah Paiman*

**Special Issue IV, 2016: <http://www.mip.org.my/doc/apsa2016.pdf>**

1. Mapping Poverty Hot Spots in Peninsular Malaysia Using Spatial Autocorrelation Analysis  
*M. Rafee Majid, Abdul Razak Jaffar, Noordini Che Man, Mehdrad Vaziri & Mohamed Sulemana*
2. Managing Urbanisation and Urban Sprawl in Malaysia by Using Remote Sensing and GIS Applications  
*Nur Aulia Rosni, Norzailawati Mohd Noor & Alias Abdullah*
3. From Trade Routes to Streets Cultures – An Overview of the Significance and Characteristics of Southeast Asian Traditional Streets  
*Mongkol Khan & Syed Zainol Abidin Idid*
4. Leadership Styles: Incentive or Disincentive Approach in Addressing Street Vendor Problems in Jakarta and Bandung, Indonesia  
*Ariva Sugandi Permana, Norsiah Abd Aziz & Ho Chin Siong*
5. Preservation of Urban Cultural Landscape: Case Study of Roji in Kagurazaka, Tokyo  
*Benika Morokuma*
6. Community Perception of Management Goals in Matoushan National Nature Reserve  
*Chengzhao Wu, Tianren Yang, Pei Pei & Haisu Chen*
7. Tripographic Assessment of VFR Travel in Context of Malaysian Domestic Travelers  
*Sharifah Eisyahyun Syed Darar & Hairul Nizam Ismail*
8. Evaluating Significant Factors that Influence Public Transport Usage in Kerman, Iran  
*Azin Bahreini, Hamed Mirzaei, Mehdi Moeinaddini, Zohreh Asadi-Shekari, Muhammad Zaly Shah & Zahid Sultan*
9. Influences of Housing Settings and Designs in Fulfilling the Malay Residents' Social Cultures

- Noor Aimran Samsudin & Syed Zainol Abidin Idid*
10. The Impact of Iskandar Malaysia Development on Urban Amenities  
*Muhammad Rafeq Razak, Foziah Johar & Rabiatul Adawiyah Abd Khalil*
  11. Factor Analysis of Motorcycle Crashes in Malaysia  
*Zahid Sultan, Noor Irdiana Ngadiman, Fara Dela A. Kadir, Nuur Fathin Roslan & Mehdi Moeinaddini*
  12. An Overview of Critical Success Factors of Public-Private Partnership in the Delivery of Urban Infrastructure and Services  
*Zayyanu Muhammad, Kim Kwang Sik, Foziah Johar & Soheil Sabri*
  13. The Provision of Vertical Social Pockets for Better Social Interaction in High-Rise Living  
*Siew Bee, Aw & Poh Im, Lim*
  14. The Rukun Warga-Based 3Rs and Waste Bank as Sustainable Solid Waste Management Strategy  
*Sherly Towolioe, Ariva Sugandi Permana & Norsiah A. Aziz, Chin Siong Ho & Dario G. Pampanga*
  15. Liveability Planning for Cities: Within the Islamic Framework of Maqasid Al-Shari'ah  
*Norimah Md Dali, Alias Abdullah & Azila Ahmad Sarkawi*
  16. Islamisation of Town Planning Education: A Review on the Courses Offered by the Department of Urban and Regional Planning, International Islamic University Malaysia  
*Azila Ahmad Sarkawi, Alias Abdullah & NorimahMd Dali*
  17. Spatiotemporal Land Use and Land Cover Change in Major River Basins in Comprehensive Development Area  
*Wan Yusryzal Wan Ibrahim & Ahmad Nazri Muhamad Ludin*
  18. Human Behaviour in Open Space around Spring Water in a Central Area of Mito-City in Japan  
*Takayuki Kumazawa*
  19. Identify Significant Indicators for a Happy City  
*Hamed Mirzaei, Azin Bahreini, Mehdi Moeinaddini, Zohreh Asadi-Shekari, Muhammad Zaly Shah & Zahid Sultan*
  20. A Discrete Choice Model for Firm Location Decision  
*Noordini Che' Man & Harry Timmerman*
  21. Co-Benefit Modelling and Optimization of Air Pollution Control in Iskandar Malaysia: A Methodology using BenMAP  
*Nadhirah Nordin, M. Rafee Majid, Ho Chin Siong & Gakuji Kurata*
  22. Exploring the Implementation and Success of Green Urban Mobility in Asian Cities  
*Zahid Sultan, Nuhu H. Timi & Mehdi Moeinaddini*
  23. Analysis of Shrines Properties using Remote Sensing Approach: Case Study of Lembah Bujang  
*Shairatul Akma Roslan, Norzailawati Mohd Noor, Alias Abdullah & Zuraini Md Ali*
  24. The Evolvement of Brand Identity of Langkawi Island, Malaysia  
*Mohd Fadil Mohd Yusof & Hairul Nizam Ismail*
  25. A Theoretical Overview of Road Hump Effects on Traffic Speed in Residential Environments  
*Khairun Sarah Radhiah Bachok, Abdul Azeez Kadar Hamsa, Mohd Zin Mohamed & Mansor Ibrahim*
  26. Implications of Sprawled and Compact Development on Mobility Patterns: A Case-Study of Bhopal, India  
*Neha Saxena & Chidambara*
  27. Research for a Comprehensive and Active Planning Method in an Industrial-Residential Mixed Area- Focused on Ota Creative Town Vision in Ota Ward, Tokyo  
*Taku Nohara, Yu Okamura & Susumu Kawahara*

28. Measuring the Dimensions and Attributes of Liveability of Low-Income Housing Communities in Nigeria  
*Sule Abass Iyanda & Mohammad Abdul Mohit*
29. An Investigation on the Relationship between Land Use Composition and PM10 Pollution in Iskandar Malaysia  
*Muhammad Azahar Zikri Zahari, M. Rafee Majid, Ho Chin Siong, Gakuji Kurata & Nadhirah Nordin*
30. Monitoring the Performance of State Structure Plan in Delivering Output using Dynamic Model  
*Muhammad Faris Abdullah, Alias Abdullah, Rustam Khairi Zahari & Samsuddin Jaafar*

**Special Issue V, 2016:**

1. Sustainable Urban Development Through Urban Consolidation Policy in Shiraz, Iran  
*Mozhgan Samzadeh, Zunaibi Abdullah, Saari Omar & Aniza Abdul Aziz*
2. An Initiatives-Based Framework for Assessing Smart City  
*Yasmin Mohd Adnan, Hasniyati Hamzah, Melasutra Md Dali, Md Nasir Daud & Anuar Alias*
3. Environmental Psychology: The Urban Built Environment Impact On Human Mental Health  
*Chen Wang, Suzaini M. Zaid & Nurhanisah Nazarali*
4. Demographic Transition and Sustainable Communities in Malaysia  
*Hanan Elsawahli, Faizah Ahmad & Azlan Shah Ali*
5. Elderly and Community Health Care Facilities: A Spatial Analysis  
*Rosilawati Zainol & Christopher J. Pettit*
6. Sustainable Housing Affordability in Sabah  
*Rosli Said, Rohayu Ab. Majid, Anuar Alias, Yasmin Mohd Adnan & Muhammad Najib Razali*
7. The Challenge of Labour Shortage for Sustainable Construction  
*Faizul Azli Mohd-Rahim, Nurul Safwah Mohd-Yusoff, Wang Chen, Nurshuhada Zainon & Rafikullah Deraman*
8. Incorporating Walking in Travel to Work: The Meaning of Commuting for Kuala Lumpur Community  
*Mastura Adam & Ahmed Abubakar*
9. Campus Walkability in Malaysian Public Universities: A Case-Study of Universiti Malaya  
*Liow Ken Keat, Naziaty Mohd Yaacob & Nor Rasidah Hashim*
10. Prevention of Aedes Breeding Habitats for Urban High-Rise Building in Malaysia  
*Nurshuhada Zainon, Faizul Azli Mohd Rahim, Dalila Roslan & Azlan Helmy Abd-Samat*
11. Energy Efficiency Policy for Existing Typical Campus Buildings in The University of Malaya  
*Muhammad Azzam Ismail, Karam M. Al-Obaidi, Raha Sulaiman*
12. Preferences of Student Residents Towards Sustainability with The Concept of Bioclimatic Design  
*Adi Ainurzaman Jamaludin, Hazreena Hussein, Nila Keumala & Ati Rosemary Mohd Ariffin*
13. Synthesising an Effective Incentives System in Safeguarding the Heritage Village of Melaka and George Town  
*Indera Syahrul Mat Radzuan & Yahaya Ahmad*

**Volume 14, 2016:**

1. Main Criteria in the Development of Smart Cities Determined using Analytical Method

*Zurinah Tahir & Jalaluddin Abdul Malek*

2. Understanding Land Idling as a Strategic Behaviour: A Brief Note Using the Real Options Approach  
*Haniza Khalid*
3. Sustainable Well-Being: An Empirical Exploration on Human Needs and Human Interdependency  
*Aisyah Abu Bakar, Mariana Mohamed Osman, Syahriah Bachok, Mansor Ibrahim & Muhammad Faris Abdullah*
4. Information Quality for Flood Risk Reduction in Site Planning: Town Planners' Perception  
*Intan Afida, Shaharudin Idrus & Halimaton Saadiah Hashim*
5. A Study on the Effects of Road Humps in Reducing Speed Along Local Roads in Residential Areas: Case Study of Taman Setiawangsa  
*Siti Syazwani Ahmad Sofi & Abdul Azeez Kadar Hamsa*
6. What Brings Youth to Recreational Park?  
*Rosilawati Zainol & Cheong Peng Au-Yong*
7. Neighbourhood Satisfaction and Qoul in Middle-Income Housing in Kuala Lumpur City, Malaysia  
*Mohammad Abdul Mohit & Mohamed Sajid Ali*
8. Identifying Factors Influencing Urban Spatial Growth for the George Town Conurbation  
*Mohd Amirul Mahamud, Narimah Samat & Norzailawati Mohd Nor*
9. The Critiques to Positivism Direction of Inquiry in Comprehending the Complexity of Governance in Managing Cities Competitiveness  
*Faizul Abdullah & Fatimah Yusof*

**Volume 15 Issue 1, 2017:**

1. Sustainability Concepts in Malay and Aceh Traditional Houses  
*By: Noor Hanita Abdul Majid, Zuraini Denan, Zaiton Abdul Rahim, Norwina Mohd Nawawi & Siti Norfakiah Hazman*
2. Choosing an Appropriate Contingency Sum Estimating Methods for Highway Construction Projects in Nigeria: A Literature Review  
*By: Razali Abdul Hamid & Fabi Jonathan Kehinde*
3. A Theoretical Assessment on Sustainable Wellbeing Indicators for People Interrelationships  
*By: Aisyah Abu Bakar, Mariana Mohamed Osman, Syahriah Bachok, Ismawi Zen, Alias Abdullah & Muhammad Faris Abdullah*
4. Field, Light and Food: Adapting the Town Square as a Leisure Gathering Space at Night  
*By: Khalilah Zakariya, Nor Zalina Harun & Mazlina Mansor*
5. The Complexity of Governing Fishing Villages in the Bagan Areas of Selangor, Malaysia  
*By: Mohd Zin Mohamed & Norhaslina Hassan*
6. Renewable Energy and Trade Disputes: Implications on Solar Photovoltaic Manufacturing in Malaysia  
*By: Hui Nee Au Yong & Kock Lim Tan*
7. Feeder Mode Choice Selection Behavioural Modelling: The Case of KTM Komuter, Kuala Lumpur  
*By: Syahriah Bachok & Siti Hajar Madina Mohd Zin*

8. Revitalization of China Town Area as Sustainable Urban Heritage in the City of Manado  
*By: VerryLahamendu, Judy O. Waani & Aristotulus E. Tungka*
9. Community-Based Tourism in Melaka UNESCO World Heritage Area: A Success in Food and Beverage Sector?  
*By: Syakir Amir, Mariana Mohamed Osman, Syahriah Bachok, Mansor Ibrahim & Ismawi Zen*
10. Feng Shui: The Shape of Five Elements of Low Ti Kok Mansion  
*By: Chong Kai Zhen & Azizi Bahauddin*
11. Appreciation of Vertical Greenery in a City as Public Art  
*By: Mazlina Mansor, Khalilah Zakariya, Nor Zalina Harun & Nur Izzah Abu Bakar*
12. Design Problem-Solving: Understanding the Significance of Iterative-Behaviour in Design  
*By: Danfulani Babangida Idi1 & Khairul Anwar Mohamed Khaidzir*
13. Architectural Heritage Restoration of Rumah Datuk Setia Via Mobile Augmented Reality Restoration  
*By: Aida Kesuma Azmin, Mohd Hisyamuddin Kassim, Fadzidah Abdullah & Alliyah Nur Zafirah Sanusi*
14. Architectural Influences of Istana Lama Seri Menanti, Negeri Sembilan  
*By: Nurdiana Zainal Abidin, Raja Nafida Raja Shahminan & Fawazul Khair Ibrahim*
15. Challenges to Implement Carrying Capacity Framework: A Case Study of Pulau Perhentian Marine Park Institutional Framework  
*By: Nadia Mohd Nasir, Mansor Ibrahim, Lukman Hakim Mahamod & Rashidi Othman*
16. A Review into the “Islamic” Tradition in the Mughal Garden: (Re) Shaping Our Stand on Islamic Art and Design  
*By: Zainab Abdul Latiff & Maheran Mohd Yaman*
17. Content Analysis of the Existence of Biomimicry Life’s Principles in Green Building Index Malaysia  
*By: Noor Aziah Mohd Ariffin & Salwa Farag Gad*
18. Revisiting Andalusian Garden: Visions for Contemporary Islamic Garden Design  
*By: Zainab Abdul Latiff & Maheran Mohd Yaman*
19. Perception of Parents and Guardians on Safe Distance for Children to Travel to Public Areas  
*By: Mariana Mohamed Osman, Muhammad Faris Abdullah, Najihan Khalid, Syahriah Bachok, Nor Suzilawati Rabe, Syafiee Shuid & Zakiah Ponrahono*
20. Daylight Characterisation of Classrooms in Heritage School Buildings  
*By: Maria Yohana Susan & Rani Prihatmanti*
21. The Benefits of River Indicators to Assess the Ecological Status of IIUM Campus  
*By: Nor Zalina Harun, Mazlina Mansor & Safiah Abu Noh*
22. Public Bus Level of Service Performance in Peninsular Malaysia: Correlation Analyses on Level of Service (LOS) and Passengers’ Satisfaction Level  
*By: Zakiah Ponrahono, Syahriah Bachok, Mariana Mohamed Osman, Mansor Ibrahim & Muhammad Faris Abdullah*
23. Translation of Social Citizenship to Architecture & Built Environment: A Methodological Review  
*By: Mohd Noorizhar Ismail, Abdul Razak Sopian, Peter Scriver & Mizanur Rashid*

24. The Impact of Intangible Factors in Shaping the Identity of Ancient Cities and Architecture of China  
*By: Tamara Kelly*
25. Housing Affordability in the State of Melaka  
*By: Mariana Mohamed Osman, Noor Suzilawati Rabe, Muhammad Faris Abdullah, Nur Farhanah Rosli & Farah Eleena Zainudin*
26. The Establishment of Islamic Dwelling Principles for the Malaysian Communities  
*By: Wan Norisma Wan Ismail, Fadli Arabi, Elina Mohd Husini, Fatin Nur Sakinah Zolkifly, Zuhairuse Md. Darus, Nor Haslina Abd. Jaafar & Azhani Abd Manaf*
27. Roles of Community Towards Urban Farming Activities  
*By: Norul Hafizah Yusoff, Mohd Ramzi Mohd Hussain & Izawati Tukiman*
28. The Tourist Behaviour in Different Environments: A Literature Review  
*By: Asra Zaliza Asbollah, Norhaslina Hassan, Safiah @ Yusmah Muhammad Yusoff & Hanizah Idris*
29. Measuring Socio-Economic Indicators for Climatic Analysis  
*By: Illyani Ibrahim*
30. Rise of Eclecticism in the 21st Century Malaysian Mosque Architecture  
*By: Amir H. Zekrgoo*
31. Bibliometric Analysis on Quantifying Urban Sprawl in Assessing a Comprehensive Meaning of Sprawl: A Review  
*By: Nur Aulia Rosni, Norzailawati Mohd Noor, & Alias Abdullah*
32. Ethics & Values in Construction Industry from Islamic Perspective  
*By: Fatma Al-Zahraa Sami & Asiah Abdul Rahim*
33. The Integration of Mosques and Churches to Urban Planning of Ibadan Nigeria: A Historical Overview  
*By: Ibraheem Mikail Abiola*
34. Modelling Willingness to Pay for Improved Public Transport Services: The Challenges of Non-Response to Stated Preference Hypothetical Questions  
*By: Syahriah Bachok & Zakiah Ponrahono*
35. Housing Affordability in the State of Johor  
*By: Mariana Mohamed Osman, Muhammad Adib Ramlee, Nasriah Samsudin, Noor Suzilawati Rabe, Muhammad Faris Abdullah, & Najihan Khalid*
36. A Review on Sustainable Wellbeing Indicators for Human Interrelationships with the Environment  
*By: Aisyah Abu Bakar, Mariana Mohamed Osman, Syahriah Bachok, Ismawi Zen, & Muhammad Faris Abdullah*
37. Young Professionals' Housing Affordability through Housing Preferences in Kuala Lumpur: Review on the Means-End Chain Model  
*By: Nor Suzylah Sohaimi, Alias Abdullah, Syafiee Shuid, & Azila Ahmad Sarkawi*
38. Local Leadership Model Towards a Resilient City in Semarang Municipality  
*By: Lilin Budiati*
39. Sidewalk Accessibility at Melaka's Traditional Streets for People with Disabilities (PwDs)  
*By: Nor Haslina Ja'afar, Asiah Abdul Rahim, Nur Amirah Abd. Samad, & Che Raiskandar Che Rahim*

**Volume 15 Issue 2, 2017:**

1. Urban Planning and The Challenges of Neoliberal Globalisation in Malaysia  
*By: Marlyana Azyyati Marzukhi, Oliver Ling Hoon Leh, & Hazlina Hamdan*
2. The Financial Costs of Urban Sprawl: Case Study of Penang State  
*By: Shahriza Osman, Jamalunlaili Abdullah, & Abdul Hadi Nawawi*
3. Combating Squatters in Malaysia: Do We Have Adequate Policies as Instrument?  
*By: Yusfida Ayu Abdullah, Julieven Nonoi Kuek, Hazlina Hamdan, & Farrah Lyana Mohd Zulkifli*
4. Social Impact of Foreign Immigrants in Affordable Housing Area. Case Study: Mentari Court, Selangor, Malaysia  
*By: Oliver Ling Hoon Leh, Nik Nurul Farahanis Mohd Rosli, Farah Ayuni Marhalim, & Siti Nur Afiqah Mohamed Musthafa*
5. Social Impact of Agro-Tourism on Local Urban Residents. Case Study: Cameron Highlands, Malaysia  
*By: Oliver Ling Hoon Leh, Mohd Hafizol Che Mohd Noor, Marlyana Azyyati Marzukhi, & Siti Nur Afiqah Mohamed Musthafa*
6. Recreational Facilities for Youth in Malaysian Urban Areas. Case Studies: Lembah Pantai, Kuala Lumpur and Kota Kinabalu, Sabah  
*By: Dasimah Omar, Kamarul Ariff Omar, Zuriyati Kamaludin, Saberi Othman, & Zaharah Mohd Yusoff*
7. Human Interaction in Urban Spaces: A Quantitative Analysis in Urban Park, Shah Alam City, Selangor  
*By: Filzani Illia Ibrahim, Dasimah bt Omar, & Nik Hanita Nik Mohamad*
8. Promoting Sustainable Travel Behavior Through Transport Policy Measures  
*By: Na'asah Nasrudin, Yusfida Ayu Abdullah, & Oliver Ling Hoon Leh*
9. Residents' Perspective on Cycling as an Option for Transportation in Putrajaya  
*By: Siti Fatimah Hashim, Habsah Hashim, & Kamarul Bahrain Shuib*
10. An Evaluation of Urban Public Transport Route. Case Study: Hop-On Hop-Off, Kuala Lumpur, Malaysia  
*By: Izzati Khairimah Ismail, Oliver Ling Hoon Leh, & Zulkifli Ahmad Zaki*
11. The Impact of Gentrification on Local Urban Heritage Identity in Old Quarter, Melaka Heritage City  
*By: Raja Norashekin Raja Othman*



**Volume 15 Issue 3, 2017:**

1. The Interplay of Spatial Policy, Travel Behaviour and Air Quality in Iskandar Malaysia  
*By: Ariva Sugandi Permana, Ahmad Nazri Muhamad Ludin, & M. Rafee Majid*
2. An Implementation Approach to Spatial Planning in Iran Case Study: The South Alborz Macroregion  
*By: Masoud Taghvaei, Hasan Beik Mohammadi, Nader Zali, & Mitra Kasaei*
3. Assessment of Bubbles in The Malaysian Housing Market  
*By: Rohayu Ab Majid, Rosli Said, & Chong, J.T.S*
4. Housing Reconstruction in A Conflict Zone – Lessons Learned from Awaran, District in Balochistan, Pakistan  
*By: Noman Ahmed*
5. Urban Spatial Pattern and Carbon Emission Interconnectivity in A Sub-Saharan City, Nigeria  
*By: Solomon Dyachia Zakka, Ariva Sungandi Permana, & M. Rafee Majid*
6. Integrated Planning Model of Creative Industry-Based Kampung Tourism in Jayengan Surakarta, Indonesia  
*By: Winny Astuti, Ariva Sugandi Permana, Qomarun, Alpha Febela, & Rufia Andisetyana*
7. Six Years (1999-2015) Of Escalating House Price: Can Fdi Be Blamed?  
*By: Ema Izati Zull, & Tajul Ariffin Masron*
8. Duplication of Urban Planning Functions in A Nigerian State: Uncovering The Causality  
*By: Oluwole Daramola, Olorunfemi Olojede, Akintayo Ojo, & Oluwaseun Olowoporoku*
9. Critical Review On the Existence of Transgenerational Entrepreneurship in Tourism Businesses: Current Trend and Interest  
*By: Mohd Alif Mohd Puzi, & Hairul Nizam Ismail*
10. A Curriculum Design for Educating Conservators of Islamic Manuscripts  
*By: Paul Hepworth, Karin Scheper, & Mandana Barkeshli*
11. A Discourse On the Persian Chahār-Bāgh as an Islamic Garden  
*By: Zainab Abdul Latiff, Mohd Yazid Mohd Yunos, & Maheran Mohd Yaman*
12. Transforming Heritage Building for Commercialisation  
*By: Prihatmanti Rani, Cantika Putri, & Adeline Devina*
13. A Review On Occupants' Satisfaction and Wellness Level in Low-Cost Housing in Malaysia  
*By: Alice Sabrina Ismail, Hazrina Haja Bava Mohidin, & Muhammad Muhaimi Daud*
14. GIS Application in Coastal Management: The Perspectives of Government Agencies in Selangor  
*By: Tuminah Paiman, & M. Zainora Asmawi*
15. Determining Barriers in Sustainable Refurbishment Projects: Commercial Building Owner Perspectives  
*By: Md Asrul Nasid Masrom, Mohd Hilmi Izwan Abd Rahim, Siow Chan Ann, Sulzakimin Mohamed, Kai Chen Goh, & Azlina Md Yassin*
16. Preference for Purpose Built Retirement Neighbourhood Among the Chinese Elderly in Small Towns in Malaysia  
*By: Norhaslina Hassan, & Tan Jiaqi*
17. An Analysis of Regional Imbalances in Iran: A Case Study of North Coastal Areas  
*By: Masoud Taghvaei, Sirous Shafaghi, & Mohammadreza Ghaderi*

**Volume 15 Issue 4, 2017:**

1. Are Green Universities Producing Greener Future Leaders?  
*By: Raihana Mohd Ghaus, Rosta Harun, Lim Kuang Hock, & Zakiah Ponrahono*
2. Street Design and Women's Safety Perception  
*By: Suhaila Abdul Rashid, Mohammad Hussaini Wahab, & Wan Nurul Mardiah Wan Mohd Rani*
3. What Drives House Price in Malaysia? In Search of an Alternative Pricing Benchmark for Islamic Home Financing  
*By: Salina Kassim, Nur Harena Redzuan, & Nor Zalina Harun*
4. Perceived Fairness in Islamic Home Financing: Comparison Between Al-Bay' Bithaman Ajil and Musharakah Mutanaqisah Partnership Contracts  
*By: Mohamed Noordeen Mohamed Intiyaz, Salina Kassim, & Nor Zalina Harun*
5. Innovative Management of Natural Resources: Case Study of Mangrove Area in Kuala Gula, Perak  
*By: Salina Nor Azam, & Tanot Unjah*
6. Sustainable Food Waste Management in Hotels: Case Study Langkawi Unesco Global Geopark  
*By: Saraswathy Kasavan, Ahmad Fariz Mohamed, and Sharina Abdul Halim*
7. Changes and Threats in The Preservation of the Traditional Malay Landscape  
*By: Nor Zalina Harun, Noor Aziah Mohd Ariffin, & Fadzidah Abdullah*
8. The Transformation of the Monoculture System Towards Sustainable Farming Practices Among Malay Smallholdings in Kluang, Johor  
*By: Nor Zalina Harun, & Anizah Mohd Salleh*
9. Eco Public Art Placemaking Framework: A Case Study of Laman Seni Shah Alam, Malaysia  
*By: Khalilah Zakariya, & Syamim Azhari*
10. Public Perception On Traffic Pollution in Federal Territory of Kuala Lumpur, Malaysia  
*By: Siti Haslina Mohd Shafie, & Mastura Mahmud*
11. A Review On the Needs to Improve Malaysian Tree Preservation Order (TPO) (Act 172)  
*By: Nik Adlin Nik Mohamed Sukri, Noriah Othman, & Wan Tarmeze Wan Ariffin*
12. Understanding Local Authority Performance Through Role Theory  
*By: Sengboon Lim, Jalaluddin Abdul Malek, & Zurinah Tahir*
13. Reviews On the Socio-Economic Indicators for Spatial Urban Scale  
*By: Illyani Ibrahim, Azizan Abu Samah, & M. Zainora Asmawi*

**Volume 16 Issue 1, 2018:**

1. Architectural Practices of Project Communication Management in Iraq  
*By: Hala Taleb Al-Mayahi, Syuhaida Ismail, Mohammad Hussaini Wahab, Wan Nurul Mardiah Wan Mohd Rani, & Rohayah Che Amat*
2. Malaysia Resilient Initiatives: Case Study of Melaka into Resilient City  
*By: Intan Syafinar Jamaludin & Noralfishah Sulaiman*
3. Experiential Virtual Urban Environments: A Preliminary Investigation  
*By: Izhah Ghani, Norhafizah Abdul Rahman, Nadiyahati Mat Nayan & Azrul Bahaluddin*

4. Social Capital Among Ageing Residents of Housing Complexes in Suburban Tokyo: The Case of Haraichi-Danchi and Oyamadai-Danchi in Ageo City  
By: *Nadhirah Nordin & Hitoshi Nakamura*
5. The Impact of Freight Vehicle Access Restriction on the Sustainability of Jakarta Intra Urban Tollway System  
By: *Nahry Yusuf*
6. Comfort Character of Landscape Features of Traditional Streets in Amman, Jordan  
By: *Saja Jamil Alamoush, Nor Haslina Ja'afar, Elina Mohd Husini, & Wan Norisma Wan Ismail*
7. The Viability of an Integrative Framework for Urban Design and Regional Environmental Justice  
By: *Stephen T.F. Poon*
8. The Impact of Road Gradient and Truck Composition on the Toll Road Traffic Performance  
By: *Nahry Yusuf & Dwi Setiyadi Sudrajat*
9. Mosque: A Statement of Citizenship  
By: *Abdul Razak Sopian, Mohd Noorizhar Ismail, Mizanur Rashid, & Wan Nurul Mardiah Wan Mohd Rani*
10. Disaster Risk Management in Malaysia: Issues and Challenges from the Persepective of Agencies  
By: *Noraini Omar Chong & Khairul Hisyam Kamarudin*
11. The Power of Accessibility to Land Price in Semarang Urban Corridors, Indonesia  
By: *Anita Ratnasari Rakhmatulloh, Imam Buchori, Wisnu Pradoto, & Bambang Riyanto*
12. Ageing in Place Framework as Reference Guide for Housing in Malaysia: Landed Property  
By: *Siti Uzairiah Mohd Tobi, Mohamad Syazli Fathi & Dilanthi Amaratunga*
13. Segregated Land Use Sprawl: TOD Approach for Mixed-Use Housing Development in Kuala Lumpur  
By: *Nur Aulia Rosni, Zakiah Ponrahono & Noorzailawati Mohd Noor*
14. Community Awareness on the Implementation of Early Warning System at Tenaga Nasional Berhad Sultan Abu Bakar Hydroelectric Scheme, Lembah Bertam, Cameron Highland  
By: *Mohd Ramzi Mohd Hussain, Ismawi Zen, Rahsidi Sabri Muda, Sivadass Thiruchelvam, Izawati Tukiman, & Aishah Naqiah Ahmad Shazili*
15. Development of Urban Market Spatial for Highest and Best Use of Land Productivity and Sustainability  
By: *Christiono Utomo, Yani Rahmawati & Iman Krestawan*
16. Universal Design in Urban Public Spaces for People with Disability. Case Study of Tehran, Iran  
By: *Elnaz Esfandfard, Mohammad Hussaini Wahab & Rohayah Che Amat*
17. Revealing Urban Marketplace Identity: Pudu  
By: *Mohamad Asri Ibrahim, Mohammad Hussaini Wahab & Sharyzee Mohamad Shukri*
18. Factors Influencing the Willingness to Walk to the Bus Stops in Penang Island  
By: *Nur Sabahiah Abdul Sukor & Siti Fadhlina Muhammad Fisal*

19. Inheriting the City: Historic Urban Landscape of George Town Unesco World Heritage Site  
By: *Rohayah Che Amat*
20. Key Issues in The Management of the Humanitarian Aid Distribution Process During and Post-Disaster in Malaysia  
By: *Suzila Mohd, Mohamad Syazli Fathi, Aizul Nahar Harun, & Noraini Omar Chong*
21. Measuring the Sway of Imperceptible Factors in Shaping the Distinct Character of Ancient Indian Architecture and City Planning  
By: *Tamara Kelly*
22. Assessment of Potential Locations for Bonus Zoning in Bandung  
By: *Tika S. D. Hasan & Denny Zulkaidi*
23. Valuer's Behavioural Uncertainties in Property Valuation Decision Making  
By: *Nur Ezra Mohammad, Hishamuddin Mohd Ali & Tuti Haryati Jasimin*
24. Mediation Effect of Social Aspect in the Relationship Between Environmental and Economic Aspects: Their Influence on the Value of Green Commercial Office Property  
By: *Tuti Haryati Jasimin*
25. Identity, Tradition and The City: Dichotomies and Realities of Creating an Urban Language of the Malay Palace  
By: *Tengku Anis Qariah Raja Abdul Kadir, Puteri Shireen Jahn Kassim & Nurul Syala Abdul Latip*
26. Human Interdependency for Sustainable Well-Being: Structural Invariance Across Settlement Areas  
By: *Aisyah Abu Bakar, Mariana Mohamed Osman, Syahriah Bachok, Mizan Hitam & Alias Abdullah*
27. Symbolism in Traditional Malay Boat Crafting in the East Coast  
By: *Mohd Rohaizat Abdul Wahab, Zuliskandar Ramli, Nurul Norain Akhemal Ismail, Nuratikah Abu Bakar, & Wan Nor Shamimi Wan Azhar*
28. Perceptual Study on Conventional Quality of Life Indicators  
By: *Noor Suzilawati Rabe, Mariana Mohamed Osman, Syahriah Bachok, Nur Farhanah Rosli, & Mohammad Faris Abdullah*
29. XRD and XRF Analysis of the Ancient Bricks from Candi Kampung Baru, Kedah  
By: *Zuliskandar Ramli, Muhammad Nu'man Mohd Nasir, Abdul Latif Samian, Nor Zalina Harun, Mohd Shamsul Bahari Abdul Hadi, Nuratikah Abu Bakar, & Nur Sarahah Mohd Supian*
30. Profiling Intercity Bus Drivers of Malaysia  
By: *Syahriah Bachok, Mariana Mohamed Osman & Muhammad Faris Abdullah*
31. House Price Movement for Primary and Secondary Markets: Evidence from Selangor, Malaysia  
By: *Haszlila Jalil Norngainy Mohd Tawil, Md Nasir Daud & Aina Edayu Ahmad*
32. Determining Model Configuration for Thermal Simulation of Urban Mosque Façade Design  
By: *Noor Hanita Abdul Majid, Fauziah Hanum Abdullah & Zuraini Denan*
33. Urban Morphological Analysis Framework for Conservation Planning and Management  
By: *Syahidah Amni Mohamed, Nor Zalina Harun & Alias Abdullah*

*The Past Issues*

34. Ancient Maritime Symbols in Malay Traditional Boat in the East Coast, Peninsular Malaysia  
By: *Mohd Rohaizat Abdul Wahab, Zuliskandar Ramli, Mohammad Anis Abdul Samad, Nur Sarahah Mohd Supian, Muhammad Nu'man Mohd Nasir, & Siti Salina Masdey*
35. Income Targets and Poverty of Rubber Smallholders at Four States of Malaysia  
By: *Siti Murni Wee Jamil Wee & Kuppusamy Singaravelloo*
36. Policy Available and Sustainable Waterfront Development  
By: *Azlina Md. Yassin, Md. Asrul Nasid Masrom, Mohd. Najib Mohd. Razali, & Yasmin Mohd. Adnan*